



Carmex
Precision Tools Ltd.



Metric 2012-13

Company Profile

Carmex Precision Tools Ltd. is a leading manufacturer of high quality cutting tools. The company was founded in 1988 in Maalot, located in the beautiful North West region of Israel.

Product Lines

Carmex specializes in the production of threading tools for turning and milling. Our product lines include Thread Turning inserts and tool holders, Mill-Thread inserts and tool holders, Mill-Thread Solid-Carbide and Spiral Mill-Thread. In addition to threading, we produce grooving tools, Mini Chamfer mills, Thread Whirling tools and the Tiny-Tools line of small boring bars for threading, turning, grooving small parts. The company's different product lines are recognized worldwide as advanced technology, reliable full range lines that offer accurate geometry, excellent cutting performance and extended tool life. Our products and the service we provide live up to the highest standards and outperform them. Carmex also produces special tools in accordance with customer's requirements.

Quality Assurance

In addition to our unyielding strive for high quality, speedy service and reliability, Carmex is certified by ISO 9001:2008, ISO 13485:2003, ISO 14001:2004, OHSAS 180001 and CE. Most of our customers' requirements are supplied immediately from our readily available wide range of stock, as well as from our agents and distributors' stocks around the world. In August 2008 Carmex completed its transfer to the new, state of the art modern building. In addition to the construction we invested in machinery and advanced equipment as part of our strategy to keep our position in the first line of high technology.

Carmex Branches

In addition to its distributors' chain, Carmex has three independant sales branches. Each of them keeps Carmex's wide range of stock and employs talented, service oriented managers, engineers, technicians and administrators willing to fulfill the customers' needs.

The branches were opened gradually,

2003 - C.P.T. GmbH, a sales branch in Stuttgart Germany serving Europe.

2004 - Carmex Precision Tools, LLC, a sales branch in Winsconsin USA serving North America and Mexico.

2008 - Carmex Italia Srl, a sales branch in Modena, Italy.

In addition to our customers' recognition of our high quality tools, we are also well known as a service oriented company and as a very competitive supplier that pledge for customer satisfaction.



THE STANDARDS INSTITUTION OF ISRAEL

ISO 9001-2008
Quality Management
Systems



THE STANDARDS INSTITUTION OF ISRAEL

ISO 13485:2003
Medical Devices
Quality Management
Systems



THE STANDARDS INSTITUTION OF ISRAEL

ISO 14001
Environmental
Management
Systems



THE STANDARDS INSTITUTION OF ISRAEL

OHSAS 18001
Occupational
Health and Safety
Management Systems

CE 0470
European Conformity

EU consumer safety,
health and
environmental
requirements

Mill-Thread

New BLU Grade

Carmex presents a new sub-micrograin grade with PVD triple layer coating. The BLU grade provides a combination of very high strength with high wear resistance.

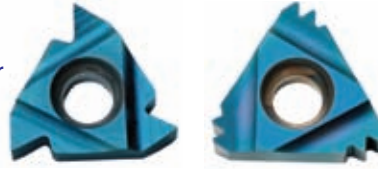

Page: 56

Large variety of vertical Inserts and Toolholders, sizes 16 up to 27

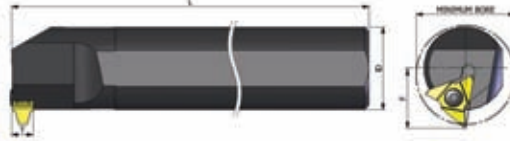

Pages: 5-27

Thread Turning Inserts for **VAM** profile

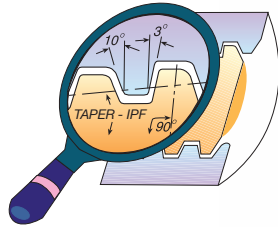

Page: 35

DSI - a unique line of 2 sided inserts including 6 cutting edges, a cost saving tool.



Page: 49-54



Grooving Inserts

Insert Size 11



Page: 64

Thread Whirling



Pages: 193-196

Solid Carbide

Mini Mill - Thread

Mini Mill-Thread for G55° profile



Page: 127

MTI - for threading deep parts, ISO and UN profile



Pages: 129-131

Mini Chamfer - Dovetail 45°



Page: 164

MTB - Solid Carbide with internal coolant bore for PG profile



Page: 120

DMT - 3 in 1

Drill, Thread, Chamfer



Pages: 135-136

Mill-Threading

CMT - Vertical Mill-Thread



Pages: 93-101

Tiny Tools

New Grade: BMK

Carbide Grade: BMK (K10 - K20)
 Sub-micron grade with advanced PVD triple coating. Extremely high heat resistant and smooth cutting operation, for high performance, and normal machining conditions.
 General purpose for all materials.



Page: 192

New Threading Tools for MIR family NPT, Trapez, Acme

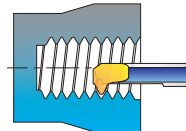

Pages: 176-179

New Products for MTR, MPR, MQR, MIR and MGR.

Page: 169-183

New Toolholders

- Toolholders for Swiss type machines.
- Toolholders with coolant channel.



Page: 189

- Toolholders with \varnothing 25 mm

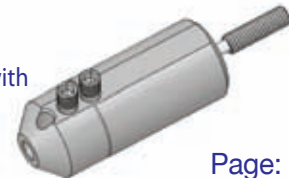

Page: 190

Large Profile Range

- Pitch Range: 14mm up to 24 mm.
- Tools and inserts are offered a specials (non catalogue), because each holder has to be adopted to fit the profile shape and customer request.
- Rigid Clamping

External























Internal



- Tailor made profiles according to customers request

Available Profile	Round (DIN 20400)	Trapez (DIN 103)	Acme, Stub Acme	American Buttress
Pitch	16 mm	14-24 mm	1.0 - 1.5 TPI	1.5 - 2.0 TPI

	CONTENTS:	Page:
	<u>Thread Turning Inserts</u>	3-36
	<u>Thread Turning Toolholders and Kits</u>	37-48
	<u>Double Sided Thread Turning Inserts and Toolholders</u>	49-54
	<u>Thread Turning Technical Section</u>	55-62
	<u>Grooving Tools</u>	63-66
	<u>Mill-Thread Inserts and Kits</u>	67-76
	<u>Mill-Thread Toolholders</u>	77-82
	D-Thread- <u>Mill-Thread Inserts and Toolholders for Machining Deep Threads</u>	83-84
	<u>Spiral Mill-Thread and Finishing</u>	85-92
	<u>CMT - Vertical Mill-Thread</u>	93-102
	<u>Mill-Thread</u>	103-122
	<u>Mini Mill-Thread</u>	123-132
	<u>DMT - 3 in 1 - Drill, Thread, Chamfer</u>	133-136
	HARD 	137-142
	<u>Mill-Thread Technical Section</u>	143-156
	<u>Solid Carbide Milling Tools for Grooving Deep Parts</u>	157-160
	<u>Mini Chamfer</u>	161-164
	<u>Turning Tools</u>	165-166
	<u>Tiny Tools</u>	167-192
	<u>Thread Whirling</u>	193-196

Thread Turning Inserts

New: BLU Grade

Carmex presents a new sub-micrograin grade with PVD triple layer coating. The BLU grade provides a combination of very high strength with high wear resistance.

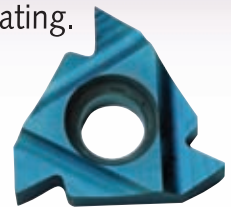

Type B - Threading Inserts

A combination of ground profile and sintered chip-breaker threading inserts. Unlike most other manufacturers' inserts, this combination ensures consistent high quality thread, with precise shape and dimensions.

Two different unique styles of chip-breaker were designed to suit the different specific requirements of Internal threads and External threads.

All of Carmex Type B inserts are made of BMA: Sub - Micrograin grade.



Contents:

Product Identification	4
Partial Profile 60°	5-6
Partial Profile 55°	7-8
ISO - metric	9-11
UN - Unified	12-15
Whitworth 55°	16-19
NPT	20-21
NPTF	22
BSPT	23-24
Acme	25
Stub Acme	26

Page:

Contents:

Trapez - DIN 103	27
PG - DIN 40430	28
Sägengewinde - DIN 513	28
Round - DIN 405	29
Round - DIN 20400	29
UNJ	30
MJ - ISO 5855	31
American Buttress	31
Oil Threads	32-34
VAM	35

Page:

Product Identification

Thread Turning Inserts Ordering Codes

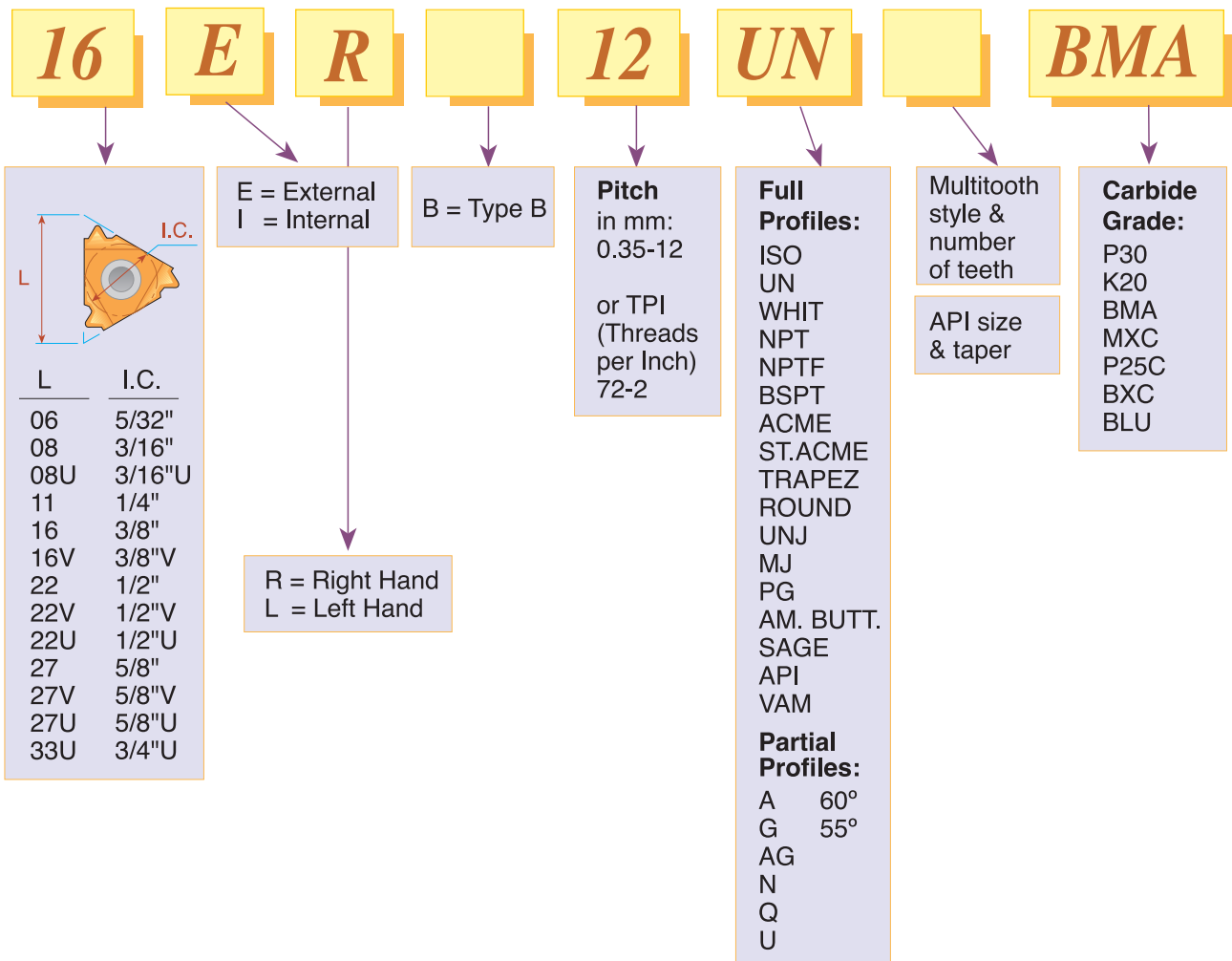

Partial Profile 60°

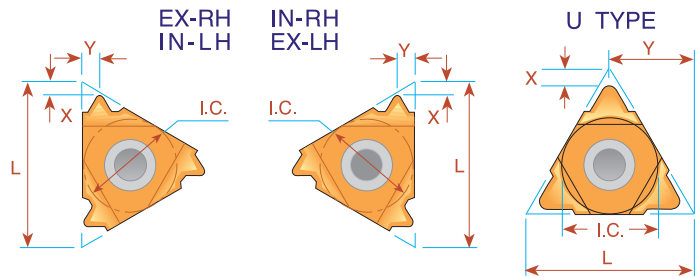
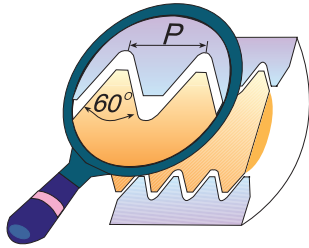

L	I.C. in	Pitch Range		EXTERNAL Ordering Code		INTERNAL Ordering Code		X	Y
		mm	TPI	Right Hand	Left Hand	Right Hand	Left Hand		
6	5/32	0.5-1.25	48-20	ULTRA MINI		*06 IR A60	*06 IL A60	0.6	0.6
8	3/16	0.5-1.5	48-16	MINI		*08 IR A60	*08 IL A60	0.6	0.7
8U	3/16U	1.75-2.0	14-11	"U" MINI		*08U IR/L U60		0.8	4.0
11	1/4	0.5-1.5	48-16	11 ER A60	11 EL A60	11 IR A60	11 IL A60	0.8	0.9
16	3/8	0.5-1.5	48-16	16 ER A60	16 EL A60	16 IR A60	16 IL A60	0.8	0.9
16	3/8	1.75-3.0	14- 8	16 ER G60	16 EL G60	16 IR G60	16 IL G60	1.2	1.7
16	3/8	0.5-3.0	48- 8	16 ER AG60	16 EL AG60	16 IR AG60	16 IL AG60	1.2	1.7
22	1/2	3.5-5.0	7- 5	22 ER N60	22 EL N60	22 IR N60	22 IL N60	1.7	2.5
22U	1/2U	5.5-8.0	4.5- 3.25	22U E/R/L U60				0.6	11.0
27	5/8	5.5-6.0	4.5- 4	27 ER Q60	27 EL Q60	27 IR Q60	27 IL Q60	2.1	3.1
27U	5/8U	6.5-9.0	4- 2.75	27U E/R/L U60				1.0	13.7

Order example: 16 ER G60 MXC

For small bore threading see page 176

* Available only in BXC grade

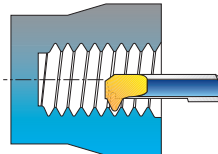

Type B

Ground Profile with Sintered Chip-breaker



L	I.C. in	Pitch Range		EXTERNAL Ordering Code	INTERNAL Ordering Code	X	Y
		mm	TPI	Right Hand	Right Hand		
16	3/8	0.5 -1.5	48-16	16 ER B A60	16 IR B A60	0.8	0.9
16	3/8	1.75-3.0	14- 8	16 ER B G60	16 IR B G60	1.2	1.7
16	3/8	0.5 -3.0	48- 8	16 ER B AG60	16 IR B AG60	1.2	1.7

Order example: 16 ER B G60 BMA

For Carbide Grade and Cutting Speed see page 56

Partial Profile 60° Vertical

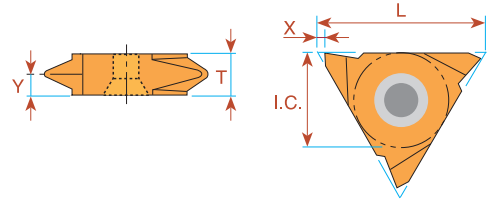

L	I.C. in	Pitch Range		EXTERNAL Ordering Code		INTERNAL Ordering Code		X	Y	T
		mm	TPI	Right Hand	Left Hand	Right Hand	Left Hand			
16	3/8	0.5 - 1.5	48-16	16V ER A60	16V EL A60			1.0	0.9	3.6
16	3/8	1.75- 3.0	14- 8	16V ER G60	16V EL G60			1.0	1.8	3.6
16	3/8	0.5 - 3.0	48- 8	16V ER AG60	16V EL AG60			1.0	1.8	3.6
22	1/2	1.75- 3.0	14- 8	22V ER G60	22V EL G60			1.2	1.7	4.0
22	1/2	0.5 - 5.0	7- 5	22V ER N60	22V EL N60			1.2	2.5	4.8
27	5/8	6.0 -10.0	4- 2.5	27V ER V60	27V EL V60	27V IR V60	27V IL V60	1.8	5.2	10.4

Order example: 16V ER G60 BMA

Partial Profile 55°

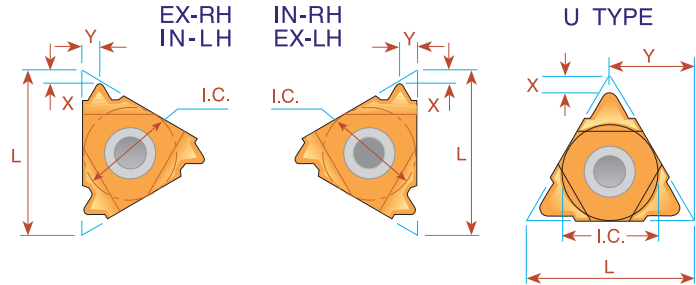
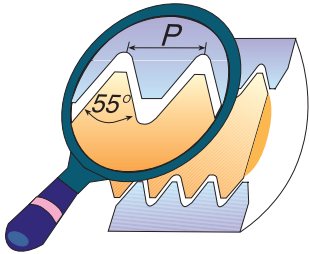

L	I.C. in	Pitch Range		EXTERNAL Ordering Code		INTERNAL Ordering Code		X	Y
		mm	TPI	Right Hand	Left Hand	Right Hand	Left Hand		
6	5/32	0.5-1.25	48-20	ULTRA -MINI →		*06 IR A55	*06 IL A55	0.5	0.6
8	3/16	0.5-1.5	48-16	MINI →		*08 IR A55	*08 IL A55	0.6	0.7
8U	3/16U	1.75-2.0	14-11	"U" MINI →		*08U IR/L U55		0.9	4.0
11	1/4	0.5-1.5	48-16	11 ER A55	11 EL A55	11 IR A55	11 IL A55	0.8	0.9
16	3/8	0.5-1.5	48-16	16 ER A55	16 EL A55	16 IR A55	16 IL A55	0.8	0.9
16	3/8	1.75-3.0	14-8	16 ER G55	16 EL G55	16 IR G55	16 IL G55	1.2	1.7
16	3/8	0.5-3.0	48-8	16 ER AG55	16 EL AG55	16 IR AG55	16 IL AG55	1.2	1.7
22	1/2	3.5-5.0	7-5	22 ER N55	22 EL N55	22 IR N55	22 IL N55	1.7	2.5
22U	1/2U	5.5-8.0	4.5-3.25	22U E/VR/L U55				0.9	11.0
27	5/8	5.5-6.0	4.5-4	27 ER Q55	27 EL Q55	27 IR Q55	27 IL Q55	2.0	2.9
27U	5/8U	6.5-9.0	4-2.75	27U E/VR/L U55				1.2	13.7

Order example: 16 ER G55 MXC
 For small bore threading see page 176
 * Available only in BXC grade

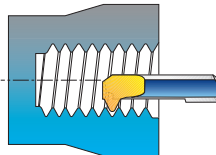

Type B

Ground Profile with Sintered Chip-breaker



L	I.C. in	Pitch Range		EXTERNAL Ordering Code	INTERNAL Ordering Code	X	Y
		mm	TPI	Right Hand	Right Hand		
16	3/8	1.75-3.0	14-8	16 ER B G55	16 IR B G55	1.2	1.7
16	3/8	0.5 -3.0	48-8	16 ER B AG55	16 IR B AG55	1.2	1.7

Order example: 16 ER B G55 BMA

Partial Profile 55° Vertical

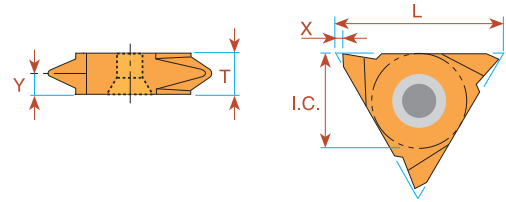

L	I.C. in	Pitch Range		EXTERNAL Ordering Code		INTERNAL Ordering Code		X	Y	T
		mm	TPI	Right Hand	Left Hand	Right Hand	Left Hand			
16	3/8	0.5 - 1.5	48-16	16V ER A55	16V EL A55			1.0	0.9	3.6
16	3/8	1.75- 3.0	14- 8	16V ER G55	16V EL G55			1.0	1.7	3.6
16	3/8	0.5 - 3.0	48- 8	16V ER AG55	16V EL AG55			1.0	1.8	3.6
22	1/2	3.5 - 5.0	7- 5	22V ER N55	22V EL N55			1.2	2.5	4.8
27	5/8	6.0 -10.0	4- 2.5	27V ER V55	27V EL V55	27V IR V55	27V IL V55	1.8	5.2	10.4

Order example: 22V ER N55 BMA

Thread Turning Inserts

ISO - metric

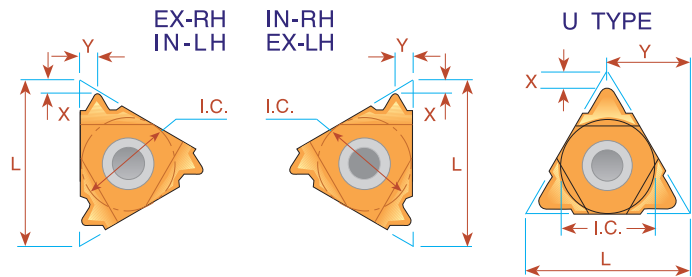
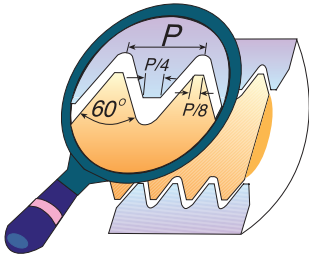

Pitch mm	L	I.C. in	EXTERNAL		X	Y	INTERNAL		X	Y
			Ordering Code Right Hand	Ordering Code Left Hand			Ordering Code Right Hand	Ordering Code Left Hand		
0.5	6	5/32	<i>ULTRA MINI</i> →				*06 IR 0.5 ISO	*06 IL 0.5 ISO	0.9	0.5
0.75	6	5/32					*06 IR 0.75 ISO	*06 IL 0.75 ISO	0.8	0.5
1.0	6	5/32					*06 IR 1.0 ISO	*06 IL 1.0 ISO	0.7	0.6
1.25	6	5/32					*06 IR 1.25 ISO	*06 IL 1.25 ISO	0.6	0.6
0.5	8	3/16	<i>MINI</i> →				*08 IR 0.5 ISO	*08 IL 0.5 ISO	0.6	0.5
0.75	8	3/16					*08 IR 0.75 ISO	*08 IL 0.75 ISO	0.6	0.5
1.0	8	3/16					*08 IR 1.0 ISO	*08 IL 1.0 ISO	0.6	0.6
1.25	8	3/16					*08 IR 1.25 ISO	*08 IL 1.25 ISO	0.6	0.7
1.5	8	3/16					*08 IR 1.5 ISO	*08 IL 1.5 ISO	0.6	0.7
1.75	8	3/16					*08 IR 1.75 ISO	*08 IL 1.75 ISO	0.6	0.8
2.0	8U	3/16U	<i>"U" MINI</i> →				*08U IR/L 2.0 ISO		0.9	4.0
0.35	11	1/4	11 ER 0.35 ISO	11 EL 0.35 ISO	0.8	0.4	11 IR 0.35 ISO	11 IL 0.35 ISO	0.8	0.3
0.4	11	1/4	11 ER 0.4 ISO	11 EL 0.4 ISO	0.7	0.4	11 IR 0.4 ISO	11 IL 0.4 ISO	0.8	0.4
0.45	11	1/4	11 ER 0.45 ISO	11 EL 0.45 ISO	0.7	0.4	11 IR 0.45 ISO	11 IL 0.45 ISO	0.8	0.4
0.5	11	1/4	11 ER 0.5 ISO	11 EL 0.5 ISO	0.6	0.6	11 IR 0.5 ISO	11 IL 0.5 ISO	0.6	0.6
0.6	11	1/4	11 ER 0.6 ISO	11 EL 0.6 ISO	0.6	0.6	11 IR 0.6 ISO	11 IL 0.6 ISO	0.6	0.6
0.7	11	1/4	11 ER 0.7 ISO	11 EL 0.7 ISO	0.6	0.6	11 IR 0.7 ISO	11 IL 0.7 ISO	0.6	0.6
0.75	11	1/4	11 ER 0.75 ISO	11 EL 0.75 ISO	0.6	0.6	11 IR 0.75 ISO	11 IL 0.75 ISO	0.6	0.6
0.8	11	1/4	11 ER 0.8 ISO	11 EL 0.8 ISO	0.6	0.6	11 IR 0.8 ISO	11 IL 0.8 ISO	0.6	0.6
1.0	11	1/4	11 ER 1.0 ISO	11 EL 1.0 ISO	0.7	0.7	11 IR 1.0 ISO	11 IL 1.0 ISO	0.6	0.7
1.25	11	1/4	11 ER 1.25 ISO	11 EL 1.25 ISO	0.8	0.9	11 IR 1.25 ISO	11 IL 1.25 ISO	0.8	0.8
1.5	11	1/4	11 ER 1.5 ISO	11 EL 1.5 ISO	0.8	1.0	11 IR 1.5 ISO	11 IL 1.5 ISO	0.8	1.0
1.75	11	1/4	11 ER 1.75 ISO	11 EL 1.75 ISO	0.8	1.1	11 IR 1.75 ISO	11 IL 1.75 ISO	0.8	1.1
2.0	11	1/4					11 IR 2.0 ISO	11 IL 2.0 ISO	0.8	0.9
2.5	11	1/4					11 IR 2.5 ISO	11 IL 2.5 ISO	0.8	1.2
0.35	16	3/8	16 ER 0.35 ISO	16 EL 0.35 ISO	0.8	0.4	16 IR 0.35 ISO	16 IL 0.35 ISO	0.8	0.3
0.4	16	3/8	16 ER 0.4 ISO	16 EL 0.4 ISO	0.7	0.4	16 IR 0.4 ISO	16 IL 0.4 ISO	0.8	0.4
0.45	16	3/8	16 ER 0.45 ISO	16 EL 0.45 ISO	0.7	0.4	16 IR 0.45 ISO	16 IL 0.45 ISO	0.8	0.4
0.5	16	3/8	16 ER 0.5 ISO	16 EL 0.5 ISO	0.6	0.6	16 IR 0.5 ISO	16 IL 0.5 ISO	0.6	0.6
0.6	16	3/8	16 ER 0.6 ISO	16 EL 0.6 ISO	0.6	0.6	16 IR 0.6 ISO	16 IL 0.6 ISO	0.6	0.6
0.7	16	3/8	16 ER 0.7 ISO	16 EL 0.7 ISO	0.6	0.6	16 IR 0.7 ISO	16 IL 0.7 ISO	0.6	0.6
0.75	16	3/8	16 ER 0.75 ISO	16 EL 0.75 ISO	0.6	0.6	16 IR 0.75 ISO	16 IL 0.75 ISO	0.6	0.6
0.8	16	3/8	16 ER 0.8 ISO	16 EL 0.8 ISO	0.6	0.6	16 IR 0.8 ISO	16 IL 0.8 ISO	0.6	0.6
1.0	16	3/8	16 ER 1.0 ISO	16 EL 1.0 ISO	0.7	0.7	16 IR 1.0 ISO	16 IL 1.0 ISO	0.6	0.7
1.25	16	3/8	16 ER 1.25 ISO	16 EL 1.25 ISO	0.8	0.9	16 IR 1.25 ISO	16 IL 1.25 ISO	0.8	0.9
1.5	16	3/8	16 ER 1.5 ISO	16 EL 1.5 ISO	0.8	1.0	16 IR 1.5 ISO	16 IL 1.5 ISO	0.8	1.0
1.75	16	3/8	16 ER 1.75 ISO	16 EL 1.75 ISO	0.9	1.2	16 IR 1.75 ISO	16 IL 1.75 ISO	0.9	1.2
2.0	16	3/8	16 ER 2.0 ISO	16 EL 2.0 ISO	1.0	1.3	16 IR 2.0 ISO	16 IL 2.0 ISO	1.0	1.3
2.5	16	3/8	16 ER 2.5 ISO	16 EL 2.5 ISO	1.1	1.5	16 IR 2.5 ISO	16 IL 2.5 ISO	1.1	1.5
3.0	16	3/8	16 ER 3.0 ISO	16 EL 3.0 ISO	1.2	1.6	16 IR 3.0 ISO	16 IL 3.0 ISO	1.1	1.5
3.5	16	3/8	16 ER 3.5 ISO	16 EL 3.5 ISO	1.2	1.7	16 IR 3.5 ISO	16 IL 3.5 ISO	1.2	1.7

ISO - metric

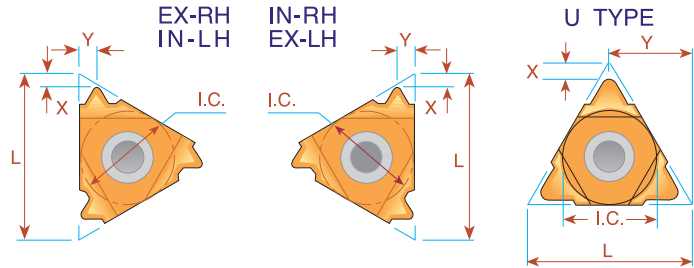
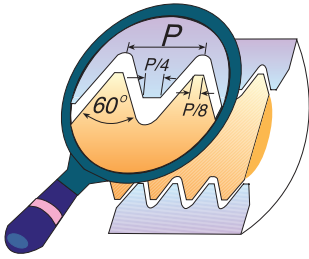

Pitch mm	L	I.C. in	EXTERNAL		X	Y	INTERNAL		X	Y
			Ordering Code Right Hand	Ordering Code Left Hand			Ordering Code Right Hand	Ordering Code Left Hand		
3.5	22	1/2	22 ER 3.5 ISO	22 EL 3.5 ISO	1.6	2.3	22 IR 3.5 ISO	22 IL 3.5 ISO	1.6	2.3
4.0	22	1/2	22 ER 4.0 ISO	22 EL 4.0 ISO	1.6	2.3	22 IR 4.0 ISO	22 IL 4.0 ISO	1.6	2.3
4.5	22	1/2	22 ER 4.5 ISO	22 EL 4.5 ISO	1.7	2.4	22 IR 4.5 ISO	22 IL 4.5 ISO	1.6	2.4
5.0	22	1/2	22 ER 5.0 ISO	22 EL 5.0 ISO	1.7	2.5	22 IR 5.0 ISO	22 IL 5.0 ISO	1.6	2.3
5.5	22	1/2	22 ER 5.5 ISO	22 EL 5.5 ISO	1.7	2.6	22 IR 5.5 ISO	22 IL 5.5 ISO	1.6	2.3
6.0	22	1/2	22 ER 6.0 ISO	22 EL 6.0 ISO	1.9	2.7	22 IR 6.0 ISO	22 IL 6.0 ISO	1.6	2.4
5.5	22U	1/2U	22U ER/L 5.5 ISO		2.3	11.0	22U IR/L 5.5 ISO		2.4	11.0
6.0	22U	1/2U	22U ER/L 6.0 ISO		2.6	11.0	22U IR/L 6.0 ISO		2.1	11.0
5.5	27	5/8	27 ER 5.5 ISO	27 EL 5.5 ISO	1.9	2.7	27 IR 5.5 ISO	27 IL 5.5 ISO	1.6	2.3
6.0	27	5/8	27 ER 6.0 ISO	27 EL 6.0 ISO	2.0	2.9	27 IR 6.0 ISO	27 IL 6.0 ISO	1.8	2.5
8.0	27U	5/8U	27U ER/L 8.0 ISO		2.4	13.7	27U IR/L 8.0 ISO		2.4	13.7
12.0	33U	3/4U	33U ER/L 12.0 ISO		2.5	16.5	33U IR/L 12.0 ISO		3.5	16.9

Order example: 22 IR 3.5 ISO BMA

For small bore threading see page 177

* Available only in BXC grade

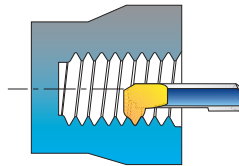

Type B

Ground Profile with Sintered Chip-breaker

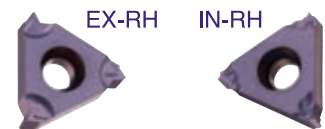

Pitch mm	L	I.C. in	EXTERNAL		X	Y	INTERNAL		X	Y
			Ordering Code Right Hand	Ordering Code Right Hand			Ordering Code Right Hand	Ordering Code Right Hand		
0.8	16	3/8	16 ER B 0.8 ISO	16 ER B 0.8 ISO	0.6	0.6	16 IR B 1.0 ISO	16 IR B 1.0 ISO	0.6	0.7
1.0	16	3/8	16 ER B 1.0 ISO	16 ER B 1.0 ISO	0.7	0.7	16 IR B 1.25 ISO	16 IR B 1.25 ISO	0.8	0.9
1.25	16	3/8	16 ER B 1.25 ISO	16 ER B 1.25 ISO	0.8	0.9	16 IR B 1.5 ISO	16 IR B 1.5 ISO	0.8	1.0
1.5	16	3/8	16 ER B 1.5 ISO	16 ER B 1.5 ISO	0.8	1.0	16 IR B 1.75 ISO	16 IR B 1.75 ISO	0.9	1.2
1.75	16	3/8	16 ER B 1.75 ISO	16 ER B 1.75 ISO	0.9	1.2	16 IR B 2.0 ISO	16 IR B 2.0 ISO	1.0	1.3
2.0	16	3/8	16 ER B 2.0 ISO	16 ER B 2.0 ISO	1.0	1.3	16 IR B 2.5 ISO	16 IR B 2.5 ISO	1.1	1.5
2.5	16	3/8	16 ER B 2.5 ISO	16 ER B 2.5 ISO	1.1	1.5	16 IR B 3.0 ISO	16 IR B 3.0 ISO	1.1	1.5
3.0	16	3/8	16 ER B 3.0 ISO	16 ER B 3.0 ISO	1.2	1.6				

Order example: 16 IR B 1.5 ISO BMA

For Carbide Grade and Cutting Speed see page 56

ISO - metric Vertical

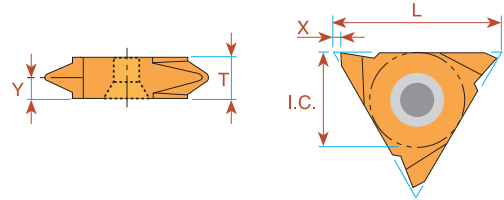

Pitch mm	L	I.C. in	EXTERNAL Ordering Code		INTERNAL Ordering Code		X	Y	T
			Right Hand	Left Hand	Right Hand	Left Hand			
0.5	16	3/8	16V ER 0.5 ISO	16V EL 0.5 ISO			1.0	0.6	3.6
0.75	16	3/8	16V ER 0.75 ISO	16V EL 0.75 ISO			1.0	0.6	3.6
0.8	16	3/8	16V ER 0.8 ISO	16V EL 0.8 ISO			1.0	0.6	3.6
1.0	16	3/8	16V ER 1.0 ISO	16V EL 1.0 ISO			1.0	0.7	3.6
1.25	16	3/8	16V ER 1.25 ISO	16V EL 1.25 ISO			1.0	0.9	3.6
1.5	16	3/8	16V ER 1.5 ISO	16V EL 1.5 ISO			1.0	0.9	3.6
1.75	16	3/8	16V ER 1.75 ISO	16V EL 1.75 ISO			1.0	1.2	3.6
2.0	16	3/8	16V ER 2.0 ISO	16V EL 2.0 ISO			1.0	1.3	3.6
2.5	16	3/8	16V ER 2.5 ISO	16V EL 2.5 ISO			1.0	1.5	3.6
3.0	16	3/8	16V ER 3.0 ISO	16V EL 3.0 ISO			1.0	1.7	3.6
8.0	27	5/8	27V ER 8.0 ISO	27V EL 8.0 ISO	27V IR 8.0 ISO	27V IL 8.0 ISO	1.8	5.2	10.4
10.0	27	5/8	27V ER 10.0 ISO	27V EL 10.0 ISO	27V IR 10.0 ISO	27V IL 10.0 ISO	1.8	5.2	10.4

Order example: 16V ER 1.5 ISO BMA

Multitooth

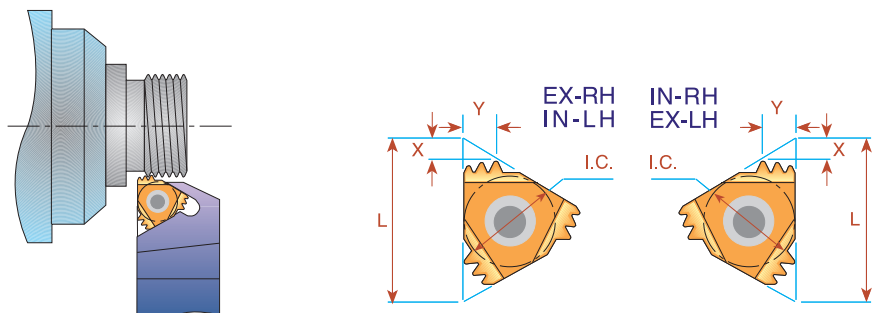

Pitch mm	L	I.C. in	Number of Teeth	EXTERNAL Ordering Code	Anvil	INTERNAL Ordering Code	Anvil	X	Y
1.0	16	3/8	3	16 ER 1.0 ISO 3M	AE16M	16 IR 1.0 ISO 3M	AI16M	1.7	2.5
1.5	16	3/8	2	16 ER 1.5 ISO 2M	AE16M	16 IR 1.5 ISO 2M	AI16M	1.5	2.3
1.5	22	1/2	3	22 ER 1.5 ISO 3M	AE22M	22 IR 1.5 ISO 3M	AI22M	2.3	3.7
2.0	22	1/2	2	22 ER 2.0 ISO 2M	AE22M	22 IR 2.0 ISO 2M	AI22M	2.0	3.0
2.0	22	1/2	3	22 ER 2.0 ISO 3M	AE22M	22 IR 2.0 ISO 3M	AI22M	3.1	5.0
3.0	27	5/8	2	27 ER 3.0 ISO 2M	AE27M	27 IR 3.0 ISO 2M	AI27M	2.9	4.6

Order example: 22 IR 2.0 ISO 2M BMA

For recommended number of passes see page 57

For Carbide Grade and Cutting Speed see page 56

UN - Unified UNC, UNF, UNEF, UNS

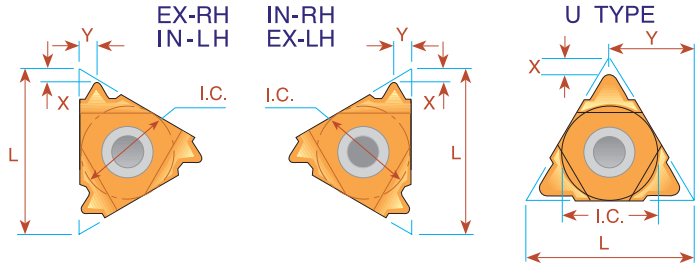
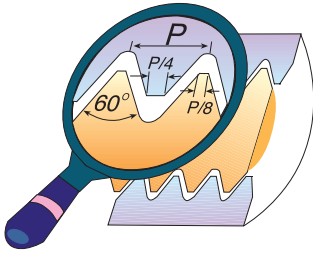

Pitch TPI	L	I.C. in	EXTERNAL		X	Y	INTERNAL		X	Y
			Ordering Code Right Hand	Ordering Code Left Hand			Ordering Code Right Hand	Ordering Code Left Hand		
32	6	5/32	<i>ULTRA MINI</i> →				*06 IR 32 UN	*06 IL 32 UN	0.8	0.5
28	6	5/32					*06 IR 28 UN	*06 IL 28 UN	0.8	0.6
24	6	5/32					*06 IR 24 UN	*06 IL 24 UN	0.7	0.6
20	6	5/32					*06 IR 20 UN	*06 IL 20 UN	0.6	0.6
18	6	5/32					*06 IR 18 UN	*06 IL 18 UN	0.6	0.7
32	8	3/16	<i>MINI</i> →				*08 IR 32 UN	*08 IL 32 UN	0.6	0.5
28	8	3/16					*08 IR 28 UN	*08 IL 28 UN	0.6	0.6
24	8	3/16					*08 IR 24 UN	*08 IL 24 UN	0.6	0.6
20	8	3/16					*08 IR 20 UN	*08 IL 20 UN	0.6	0.7
18	8	3/16					*08 IR 18 UN	*08 IL 18 UN	0.6	0.7
16	8	3/16					*08 IR 16 UN	*08 IL 16 UN	0.6	0.7
14	8	3/16					*08 IR 14 UN	*08 IL 14 UN	0.6	0.8
13	8	3/16	**08 IR 13 UN		0.8	0.9				
13	8U	3/16U	<i>"U" MINI</i> →				*08U IR/L 13 UN		1.0	4.0
12	8U	3/16U					*08U IR/L 12 UN		0.9	4.0
11	8U	3/16U					*08U IR/L 11 UN		0.9	4.0
72	11	1/4	11 ER 72 UN	11 EL 72 UN	0.8	0.4	11 IR 72 UN	11 IL 72 UN	0.8	0.3
64	11	1/4	11 ER 64 UN	11 EL 64 UN	0.8	0.4	11 IR 64 UN	11 IL 64 UN	0.8	0.4
56	11	1/4	11 ER 56 UN	11 EL 56 UN	0.7	0.4	11 IR 56 UN	11 IL 56 UN	0.7	0.4
48	11	1/4	11 ER 48 UN	11 EL 48 UN	0.6	0.6	11 IR 48 UN	11 IL 48 UN	0.6	0.6
44	11	1/4	11 ER 44 UN	11 EL 44 UN	0.6	0.6	11 IR 44 UN	11 IL 44 UN	0.6	0.6
40	11	1/4	11 ER 40 UN	11 EL 40 UN	0.6	0.6	11 IR 40 UN	11 IL 40 UN	0.6	0.6
36	11	1/4	11 ER 36 UN	11 EL 36 UN	0.6	0.6	11 IR 36 UN	11 IL 36 UN	0.6	0.6
32	11	1/4	11 ER 32 UN	11 EL 32 UN	0.6	0.6	11 IR 32 UN	11 IL 32 UN	0.6	0.6
28	11	1/4	11 ER 28 UN	11 EL 28 UN	0.6	0.7	11 IR 28 UN	11 IL 28 UN	0.6	0.7
27	11	1/4	11 ER 27 UN	11 EL 27 UN	0.7	0.8	11 IR 27 UN	11 IL 27 UN	0.7	0.8
24	11	1/4	11 ER 24 UN	11 EL 24 UN	0.7	0.8	11 IR 24 UN	11 IL 24 UN	0.7	0.8
20	11	1/4	11 ER 20 UN	11 EL 20 UN	0.8	0.9	11 IR 20 UN	11 IL 20 UN	0.8	0.9
18	11	1/4	11 ER 18 UN	11 EL 18 UN	0.8	1.0	11 IR 18 UN	11 IL 18 UN	0.8	1.0
16	11	1/4	11 ER 16 UN	11 EL 16 UN	0.9	1.1	11 IR 16 UN	11 IL 16 UN	0.9	1.1
14	11	1/4	11 ER 14 UN	11 EL 14 UN	0.9	1.1	11 IR 14 UN	11 IL 14 UN	0.9	1.1
13	11	1/4					11 IR 13 UN	11 IL 13 UN	0.8	1.0
12	11	1/4					11 IR 12 UN	11 IL 12 UN	0.9	1.1
11	11	1/4					11 IR 11 UN	11 IL 11 UN	0.8	1.1
72	16	3/8	16 ER 72 UN	16 EL 72 UN	0.8	0.4	16 IR 72 UN	16 IL 72 UN	0.8	0.3
64	16	3/8	16 ER 64 UN	16 EL 64 UN	0.8	0.4	16 IR 64 UN	16 IL 64 UN	0.8	0.4
56	16	3/8	16 ER 56 UN	16 EL 56 UN	0.7	0.4	16 IR 56 UN	16 IL 56 UN	0.7	0.4
48	16	3/8	16 ER 48 UN	16 EL 48 UN	0.6	0.6	16 IR 48 UN	16 IL 48 UN	0.6	0.6
44	16	3/8	16 ER 44 UN	16 EL 44 UN	0.6	0.6	16 IR 44 UN	16 IL 44 UN	0.6	0.6
40	16	3/8	16 ER 40 UN	16 EL 40 UN	0.6	0.6	16 IR 40 UN	16 IL 40 UN	0.6	0.6
36	16	3/8	16 ER 36 UN	16 EL 36 UN	0.6	0.6	16 IR 36 UN	16 IL 36 UN	0.6	0.6

* Available only in BXC grade.

** To be used only with holder SIR0009K08 - 1/2 - 13UNC on page 48

Thread Turning Inserts

UN - Unified UNC, UNF, UNEF, UNS

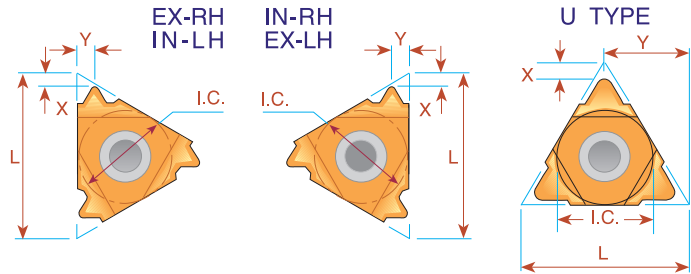
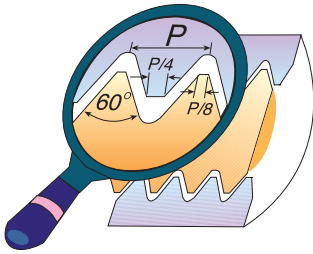

Pitch TPI	L	I.C. in	EXTERNAL		X	Y	INTERNAL		X	Y
			Right Hand	Left Hand			Right Hand	Left Hand		
32	16	3/8	16 ER 32 UN	16 EL 32 UN	0.6	0.6	16 IR 32 UN	16 IL 32 UN	0.6	0.6
28	16	3/8	16 ER 28 UN	16 EL 28 UN	0.6	0.7	16 IR 28 UN	16 IL 28 UN	0.6	0.7
27	16	3/8	16 ER 27 UN	16 EL 27 UN	0.7	0.8	16 IR 27 UN	16 IL 27 UN	0.7	0.8
24	16	3/8	16 ER 24 UN	16 EL 24 UN	0.7	0.8	16 IR 24 UN	16 IL 24 UN	0.7	0.8
20	16	3/8	16 ER 20 UN	16 EL 20 UN	0.8	0.9	16 IR 20 UN	16 IL 20 UN	0.8	0.9
18	16	3/8	16 ER 18 UN	16 EL 18 UN	0.8	1.0	16 IR 18 UN	16 IL 18 UN	0.8	1.0
16	16	3/8	16 ER 16 UN	16 EL 16 UN	0.9	1.1	16 IR 16 UN	16 IL 16 UN	0.9	1.1
14	16	3/8	16 ER 14 UN	16 EL 14 UN	1.0	1.2	16 IR 14 UN	16 IL 14 UN	0.9	1.2
13	16	3/8	16 ER 13 UN	16 EL 13 UN	1.0	1.3	16 IR 13 UN	16 IL 13 UN	1.0	1.3
12	16	3/8	16 ER 12 UN	16 EL 12 UN	1.1	1.4	16 IR 12 UN	16 IL 12 UN	1.1	1.4
11.5	16	3/8	16 ER 11.5 UN	16 EL 11.5 UN	1.1	1.5	16 IR 11.5 UN	16 IL 11.5 UN	1.1	1.5
11	16	3/8	16 ER 11 UN	16 EL 11 UN	1.1	1.5	16 IR 11 UN	16 IL 11 UN	1.1	1.5
10	16	3/8	16 ER 10 UN	16 EL 10 UN	1.1	1.5	16 IR 10 UN	16 IL 10 UN	1.1	1.5
9	16	3/8	16 ER 9 UN	16 EL 9 UN	1.2	1.7	16 IR 9 UN	16 IL 9 UN	1.2	1.7
8	16	3/8	16 ER 8 UN	16 EL 8 UN	1.2	1.6	16 IR 8 UN	16 IL 8 UN	1.1	1.5
7	22	1/2	22 ER 7 UN	22 EL 7 UN	1.6	2.3	22 IR 7 UN	22 IL 7 UN	1.6	2.3
6	22	1/2	22 ER 6 UN	22 EL 6 UN	1.6	2.3	22 IR 6 UN	22 IL 6 UN	1.6	2.3
5	22	1/2	22 ER 5 UN	22 EL 5 UN	1.7	2.5	22 IR 5 UN	22 IL 5 UN	1.6	2.3
4.5	22U	1/2U	22U ER/L 4.5 UN		2.0	11.0	22U IR/L 4.5 UN		2.4	11.0
4	22U	1/2U	22U ER/L 4 UN		2.0	11.0	22U IR/L 4 UN		2.4	11.0
4.5	27	5/8	27 ER 4.5 UN	27 EL 4.5 UN	1.9	2.7	27 IR 4.5 UN	27 IL 4.5 UN	1.7	2.4
4	27	5/8	27 ER 4 UN	27 EL 4 UN	2.1	3.0	27 IR 4 UN	27 IL 4 UN	1.8	2.7
3	27U	5/8U	27U ER/L 3 UN		2.5	13.7	27U IR/L 3 UN		2.7	13.7
2	33U	3/4U	33U ER/L 2 UN		2.8	16.5	33U IR/L 2 UN		3.6	16.9

Order example: 16 ER 12 UN BMA

For small bore threading see page 177

* Available only in BXC grade

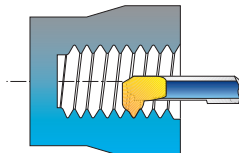

UN - Unified Vertical

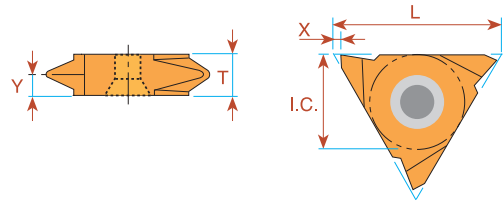

Pitch TPI	L	I.C. in	EXTERNAL Ordering Code		INTERNAL Ordering Code		X	Y	T
			Right Hand	Left Hand	Right Hand	Left Hand			
32	16	3/8	16V ER 32 UN	16V EL 32 UN			1.0	0.6	3.6
28	16	3/8	16V ER 28 UN	16V EL 28 UN			1.0	0.7	3.6
24	16	3/8	16V ER 24 UN	16V EL 24 UN			1.0	0.8	3.6
20	16	3/8	16V ER 20 UN	16V EL 20 UN			1.0	0.9	3.6
18	16	3/8	16V ER 18 UN	16V EL 18 UN			1.0	1.0	3.6
16	16	3/8	16V ER 16 UN	16V EL 16 UN			1.0	1.1	3.6
14	16	3/8	16V ER 14 UN	16V EL 14 UN			1.0	1.2	3.6
12	16	3/8	16V ER 12 UN	16V EL 12 UN			1.0	1.4	3.6
10	16	3/8	16V ER 10 UN	16V EL 10 UN			1.0	1.5	3.6
8	16	3/8	16V ER 8 UN	16V EL 8 UN			1.0	1.6	3.6
7	22	1/2	22V ER 7 UN	22V EL 7 UN			1.2	2.3	4.8
3	27	5/8	27V ER 3 UN	27V EL 3 UN	27V IR 3 UN	27V IL 3 UN	1.8	5.2	10.4

Order example: 27V EL 3 UN BMA

UN - Unified UNC, UNF, UNEF, UNS Type B

Ground Profile with Sintered Chip-breaker

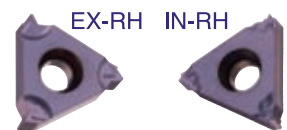

Pitch TPI	L	I.C. in	EXTERNAL Ordering Code		X	Y	INTERNAL Ordering Code		X	Y
			Right Hand	Left Hand			Right Hand	Left Hand		
24	16	3/8	16 ER B 24 UN		0.7	0.8	16 IR B 24 UN		0.7	0.8
20	16	3/8	16 ER B 20 UN		0.8	0.9	16 IR B 20 UN		0.8	0.9
18	16	3/8	16 ER B 18 UN		0.8	1.0	16 IR B 18 UN		0.8	1.0
16	16	3/8	16 ER B 16 UN		0.9	1.1	16 IR B 16 UN		0.9	1.1
14	16	3/8	16 ER B 14 UN		1.0	1.2	16 IR B 14 UN		0.9	1.2
13	16	3/8	16 ER B 13 UN		1.0	1.3				
12	16	3/8	16 ER B 12 UN		1.1	1.4	16 IR B 12 UN		1.1	1.4
11	16	3/8	16 ER B 11 UN		1.1	1.5				
10	16	3/8	16 ER B 10 UN		1.1	1.5	16 IR B 10 UN		1.1	1.5
9	16	3/8	16 ER B 9 UN		1.2	1.7				
8	16	3/8	16 ER B 8 UN		1.2	1.6	16 IR B 8 UN		1.1	1.1

Order example: 16 IR B 12 UN BMA

Multitooth

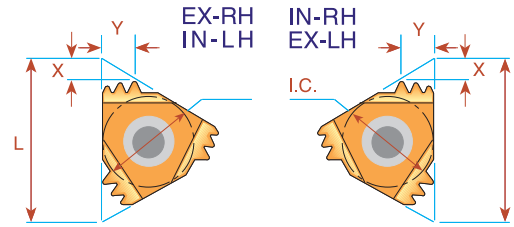
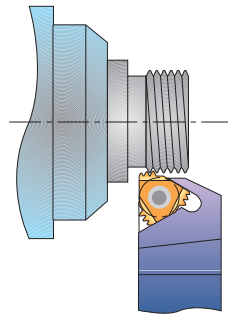

Pitch TPI	L	I.C. in	Number of Teeth	EXTERNAL Ordering Code	Anvil	INTERNAL Ordering Code	Anvil	X	Y
16	16	3/8	2	16 ER 16 UN 2M	AE16M	16 IR 16 UN 2M	AI16M	1.5	2.3
16	22	1/2	3	22 ER 16 UN 3M	AE22M	22 IR 16 UN 3M	AI22M	2.5	4.0
12	22	1/2	2	22 ER 12 UN 2M	AE22M	22 IR 12 UN 2M	AI22M	2.2	3.4
12	22	1/2	3	22 ER 12 UN 3M	AE22M	22 IR 12 UN 3M	AI22M	3.3	5.3
8	27	5/8	2	27 ER 8 UN 2M	AE27M	27 IR 8 UN 2M	AI27M	3.1	4.9

Order example: 22 IR 16 UN 3M BMA

For recommended number of passes see page 57

For Carbide Grade and Cutting Speed see page 56

Whitworth - 55° BSW, BSF, BSP, BSB

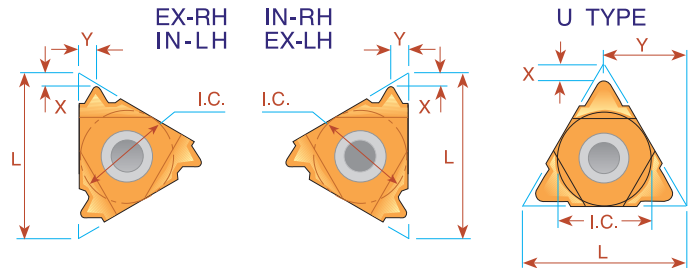
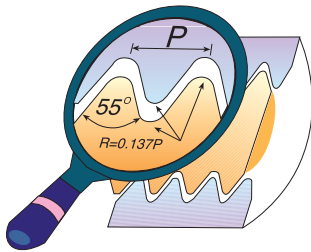

Pitch TPI	L	I.C. in	EXTERNAL Ordering Code		INTERNAL Ordering Code		X	Y
			Right Hand	Left Hand	Right Hand	Left Hand		
26	6	5/32	<i>ULTRA - MINI</i> →		*06 IR 26 W	*06 IL 26 W	0.7	0.6
22	6	5/32			*06 IR 22 W	*06 IL 22 W	0.6	0.6
20	6	5/32			*06 IR 20 W	*06 IL 20 W	0.6	0.7
18	6	5/32			*06 IR 18 W	*06 IL 18 W	0.6	0.7
28	8	3/16	<i>MINI</i> →		*08 IR 28 W	*08 IL 28 W	0.6	0.6
24	8	3/16			*08 IR 24 W	*08 IL 24 W	0.6	0.6
20	8	3/16			*08 IR 20 W	*08 IL 20 W	0.6	0.7
19	8	3/16			*08 IR 19 W	*08 IL 19 W	0.6	0.7
18	8	3/16			*08 IR 18 W	*08 IL 18 W	0.6	0.7
16	8	3/16			*08 IR 16 W	*08 IL 16 W	0.6	0.7
14	8U	3/16U	<i>"U" MINIATURE</i> →		*08U IR/L 14 W		1.0	4.0
12	8U	3/16U			*08U IR/L 12 W		0.9	4.0
11	8U	3/16U			*08U IR/L 11 W		0.9	4.0
72	11	1/4	11 ER 72 W	11 EL 72 W	11 IR 72 W	11 IL 72 W	0.7	0.4
60	11	1/4	11 ER 60 W	11 EL 60 W	11 IR 60 W	11 IL 60 W	0.7	0.4
56	11	1/4	11 ER 56 W	11 EL 56 W	11 IR 56 W	11 IL 56 W	0.7	0.4
48	11	1/4	11 ER 48 W	11 EL 48 W	11 IR 48 W	11 IL 48 W	0.6	0.6
40	11	1/4	11 ER 40 W	11 EL 40 W	11 IR 40 W	11 IL 40 W	0.6	0.6
36	11	1/4	11 ER 36 W	11 EL 36 W	11 IR 36 W	11 IL 36 W	0.6	0.6
32	11	1/4	11 ER 32 W	11 EL 32 W	11 IR 32 W	11 IL 32 W	0.6	0.6
28	11	1/4	11 ER 28 W	11 EL 28 W	11 IR 28 W	11 IL 28 W	0.6	0.7
26	11	1/4	11 ER 26 W	11 EL 26 W	11 IR 26 W	11 IL 26 W	0.7	0.7
24	11	1/4	11 ER 24 W	11 EL 24 W	11 IR 24 W	11 IL 24 W	0.7	0.8
22	11	1/4	11 ER 22 W	11 EL 22 W	11 IR 22 W	11 IL 22 W	0.8	0.9
20	11	1/4	11 ER 20 W	11 EL 20 W	11 IR 20 W	11 IL 20 W	0.8	0.9
19	11	1/4	11 ER 19 W	11 EL 19 W	11 IR 19 W	11 IL 19 W	0.8	1.0
18	11	1/4	11 ER 18 W	11 EL 18 W	11 IR 18 W	11 IL 18 W	0.8	1.0
16	11	1/4	11 ER 16 W	11 EL 16 W	11 IR 16 W	11 IL 16 W	0.9	1.1
14	11	1/4	11 ER 14 W	11 EL 14 W	11 IR 14 W	11 IL 14 W	0.9	1.1
12	11	1/4			11 IR 12 W	11 IL 12 W	1.0	1.1
11	11	1/4			11 IR 11 W	11 IL 11 W	0.9	1.2
72	16	3/8	16 ER 72 W	16 EL 72 W	16 IR 72 W	16 IL 72 W	0.7	0.4
60	16	3/8	16 ER 60 W	16 EL 60 W	16 IR 60 W	16 IL 60 W	0.7	0.4
56	16	3/8	16 ER 56 W	16 EL 56 W	16 IR 56 W	16 IL 56 W	0.7	0.4
48	16	3/8	16 ER 48 W	16 EL 48 W	16 IR 48 W	16 IL 48 W	0.6	0.6
40	16	3/8	16 ER 40 W	16 EL 40 W	16 IR 40 W	16 IL 40 W	0.6	0.6
36	16	3/8	16 ER 36 W	16 EL 36 W	16 IR 36 W	16 IL 36 W	0.6	0.6
32	16	3/8	16 ER 32 W	16 EL 32 W	16 IR 32 W	16 IL 32 W	0.6	0.6
28	16	3/8	16 ER 28 W	16 EL 28 W	16 IR 28 W	16 IL 28 W	0.6	0.7
26	16	3/8	16 ER 26 W	16 EL 26 W	16 IR 26 W	16 IL 26 W	0.7	0.7
24	16	3/8	16 ER 24 W	16 EL 24 W	16 IR 24 W	16 IL 24 W	0.7	0.8

Whitworth - 55° BSW, BSF, BSP, BSB

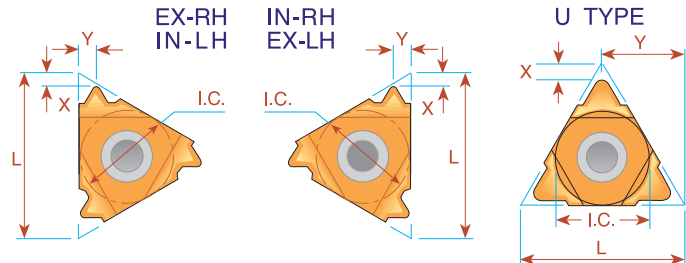
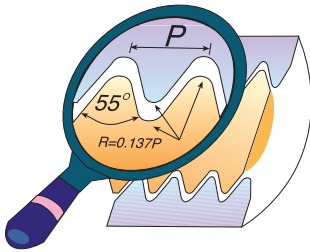

Pitch TPI	L	I.C. in	EXTERNAL Ordering Code		INTERNAL Ordering Code		X	Y
			Right Hand	Left Hand	Right Hand	Left Hand		
22	16	3/8	16 ER 22 W	16 EL 22 W	16 IR 22 W	16 IL 22 W	0.8	0.9
20	16	3/8	16 ER 20 W	16 EL 20 W	16 IR 20 W	16 IL 20 W	0.8	0.9
19	16	3/8	16 ER 19 W	16 EL 19 W	16 IR 19 W	16 IL 19 W	0.8	1.0
18	16	3/8	16 ER 18 W	16 EL 18 W	16 IR 18 W	16 IL 18 W	0.8	1.0
16	16	3/8	16 ER 16 W	16 EL 16 W	16 IR 16 W	16 IL 16 W	0.9	1.1
14	16	3/8	16 ER 14 W	16 EL 14 W	16 IR 14 W	16 IL 14 W	1.0	1.2
12	16	3/8	16 ER 12 W	16 EL 12 W	16 IR 12 W	16 IL 12 W	1.1	1.4
11	16	3/8	16 ER 11 W	16 EL 11 W	16 IR 11 W	16 IL 11 W	1.1	1.5
10	16	3/8	16 ER 10 W	16 EL 10 W	16 IR 10 W	16 IL 10 W	1.1	1.5
9	16	3/8	16 ER 9 W	16 EL 9 W	16 IR 9 W	16 IL 9 W	1.2	1.7
8	16	3/8	16 ER 8 W	16 EL 8 W	16 IR 8 W	16 IL 8 W	1.2	1.5
7	22	1/2	22 ER 7 W	22 EL 7 W	22 IR 7 W	22 IL 7 W	1.6	2.3
6	22	1/2	22 ER 6 W	22 EL 6 W	22 IR 6 W	22 IL 6 W	1.6	2.3
5	22	1/2	22 ER 5 W	22 EL 5 W	22 IR 5 W	22 IL 5 W	1.7	2.4
4.5	22U	1/2U	22U E/R/L 4.5W				2.3	11.0
4	22U	1/2U	22U E/R/L 4 W				1.8	11.0
4.5	27	5/8	27 ER 4.5W	27 EL 4.5W	27 IR 4.5W	27 IL 4.5W	1.8	2.6
4	27	5/8	27 ER 4 W	27 EL 4 W	27 IR 4 W	27 IL 4 W	2.0	2.9
3.5	27U	5/8U	27U E/R/L 3.5 W				2.1	13.7
3.25	27U	5/8U	27U E/R/L 3.25W				2.0	13.7
3	27U	5/8U	27U E/R/L 3 W				2.3	13.7
2.75	27U	5/8U	27U E/R/L 2.75W				2.4	13.7

Order example: 16 IR 18 W BMA

* Available only in BXC grade

Whitworth - 55° BSW, BSF, BSP, BSB

Type B

Ground Profile with Sintered Chip-breaker

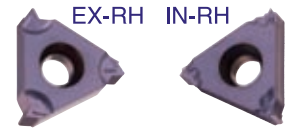

Pitch TPI	L	I.C. in	EXTERNAL	INTERNAL	X	Y
			Ordering Code Right Hand	Ordering Code Right Hand		
19	16	3/8	16 ER B 19 W	16 IR B 19 W	0.8	1.0
16	16	3/8	16 ER B 16 W	16 IR B 16 W	0.9	1.1
14	16	3/8	16 ER B 14 W	16 IR B 14 W	1.0	1.2
11	16	3/8	16 ER B 11 W	16 IR B 11 W	1.1	1.5
10	16	3/8	16 ER B 10 W	16 IR B 10 W	1.1	1.5

Order example: 16 IR B 10 W BMA

Vertical

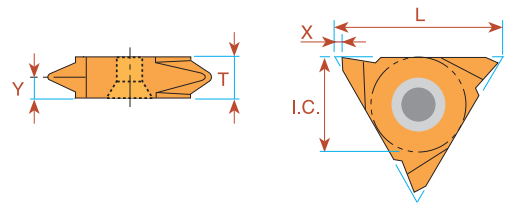

Pitch TPI	L	I.C. in	EXTERNAL	INTERNAL	X	Y	T
			Ordering Code Right Hand	Ordering Code Right Hand			
20	16	3/8	16V ER 20 W	16V EL 20 W	1.0	0.9	3.6
19	16	3/8	16V ER 19 W	16V EL 19 W	1.0	0.9	3.6
18	16	3/8	16V ER 18 W	16V EL 18 W	1.0	1.0	3.6
16	16	3/8	16V ER 16 W	16V EL 16 W	1.0	1.0	3.6
14	16	3/8	16V ER 14 W	16V EL 14 W	1.0	1.2	3.6
12	16	3/8	16V ER 12 W	16V EL 12 W	1.0	1.4	3.6
11	16	3/8	16V ER 11 W	16V EL 11 W	1.0	1.5	3.6

Order example: 16V ER 14 W MXC

Multitooth

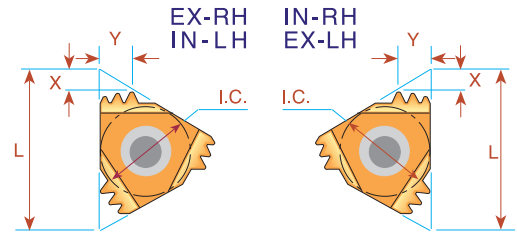
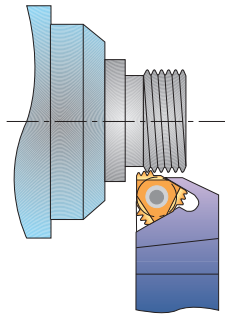

Pitch TPI	L	I.C. in	Number of Teeth	EXTERNAL Ordering Code	Anvil	INTERNAL Ordering Code	Anvil	X	Y
14	16	3/8	2	16 ER 14 W 2M	AE16M	16 IR 14 W 2M	AI16M	1.7	2.7
14	22	1/2	3	22 ER 14 W 3M	AE22M	22 IR 14 W 3M	AI22M	2.8	4.5
11	22	1/2	2	22 ER 11 W 2M	AE22M	22 IR 11 W 2M	AI22M	2.3	3.4

Order example: 16 ER 14 W 2M MXC

For recommended number of passes see page 57

For Carbide Grade and Cutting Speed see page 56

NPT

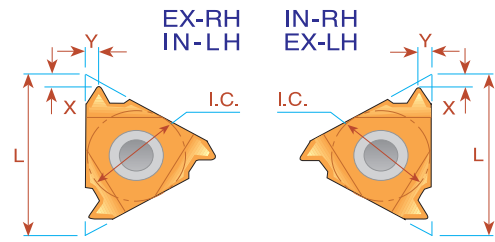
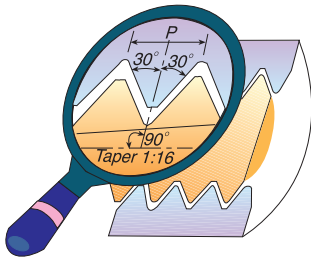

Pitch TPI	L	I.C. in	EXTERNAL Ordering Code		INTERNAL Ordering Code		X	Y
			Right Hand	Left Hand	Right Hand	Left Hand		
27	6	5/32	ULTRA MINIATURE →		* 06 IR 27 NPT	* 06 IL 27 NPT	0.6	0.6
27	8	3/16	MINIATURE →		* 08 IR 27 NPT	* 08 IL 27 NPT	0.6	0.6
18	8	3/16			* 08 IR 18 NPT	* 08 IL 18 NPT	0.6	0.6
27	11	1/4	11 ER 27 NPT	11 EL 27 NPT	11 IR 27 NPT	11 IL 27 NPT	0.7	0.8
18	11	1/4	11 ER 18 NPT	11 EL 18 NPT	11 IR 18 NPT	11 IL 18 NPT	0.8	1.0
14	11	1/4	11 ER 14 NPT	11 EL 14 NPT	11 IR 14 NPT	11 IL 14 NPT	0.8	1.0
27	16	3/8	16 ER 27 NPT	16 EL 27 NPT	16 IR 27 NPT	16 IL 27 NPT	0.7	0.8
18	16	3/8	16 ER 18 NPT	16 EL 18 NPT	16 IR 18 NPT	16 IL 18 NPT	0.8	1.0
14	16	3/8	16 ER 14 NPT	16 EL 14 NPT	16 IR 14 NPT	16 IL 14 NPT	0.9	1.2
11.5	16	3/8	16 ER 11.5 NPT	16 EL 11.5 NPT	16 IR 11.5 NPT	16 IL 11.5 NPT	1.1	1.5
8	16	3/8	16 ER 8 NPT	16 EL 8 NPT	16 IR 8 NPT	16 IL 8 NPT	1.3	1.8

Order example: 16 ER 14 NPT MXC

For small bore threading see page 178

* Available only in BXC grade

Type B

Ground Profile with Sintered Chip-breaker

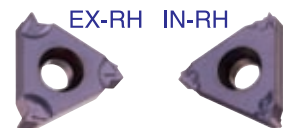

Pitch TPI	L	I.C. in	EXTERNAL Ordering Code		INTERNAL Ordering Code		X	Y
			Right Hand	Right Hand	Right Hand	Right Hand		
18	16	3/8	16 ER B 18 NPT	16 IR B 18 NPT	16 IR B 18 NPT	0.8	1.0	
14	16	3/8	16 ER B 14 NPT	16 IR B 14 NPT	16 IR B 14 NPT	0.9	1.2	
11.5	16	3/8	16 ER B 11.5 NPT	16 IR B 11.5 NPT	16 IR B 11.5 NPT	1.1	1.5	
8	16	3/8	16 ER B 8 NPT	16 IR B 8 NPT	16 IR B 8 NPT	1.3	1.8	

Order example: 16 IR B 11.5 NPT BMA

For Carbide Grade and Cutting Speed see page 56

NPT Multitooth

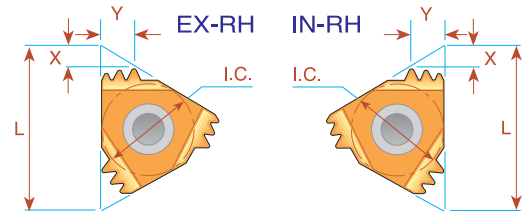
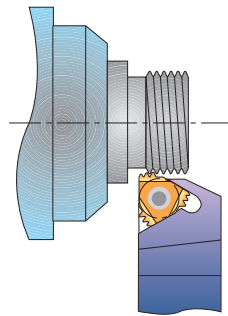

Pitch TPI	L	I.C. in	Number of Teeth	EXTERNAL		INTERNAL		X	Y
				Ordering Code	Anvil	Ordering Code	Anvil		
11.5	22	1/2	2	22 ER 11.5 NPT 2M	AE22M	22 IR 11.5 NPT 2M	AI22M	2.3	3.5
11.5	27	5/8	3	27 ER 11.5 NPT 3M	AE27M	27 IR 11.5 NPT 3M	AI27M	3.3	5.5
8	27	5/8	2	27 ER 8 NPT 2M	AE27M	27 IR 8 NPT 2M	AI27M	3.1	5.0

Order example: 27 IR 11.5 NPT 3M BMA

For recommended number of passes see page 57

NPT Vertical

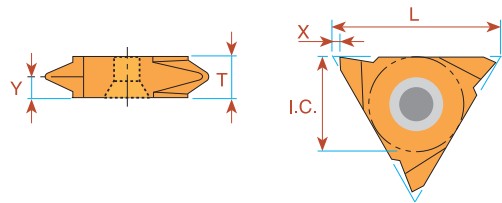

Pitch TPI	L	I.C. in	EXTERNAL		X	Y	T
			Right Hand Ordering Code	Left Hand Ordering Code			
27	16	3/8	16V ER 27 NPT	16V EL 27 NPT	1.0	0.8	3.6
18	16	3/8	16V ER 18 NPT	16V EL 18 NPT	1.0	1.0	3.6
14	16	3/8	16V ER 14 NPT	16V EL 14 NPT	1.0	1.2	3.6
11.5	16	3/8	16V ER 11.5 NPT	16V EL 11.5 NPT	1.0	1.5	3.6

Order example: 16V ER 14 NPT BMA

NPTF - Dryseal

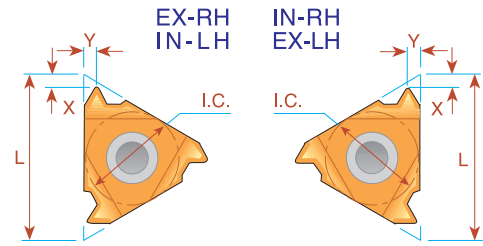
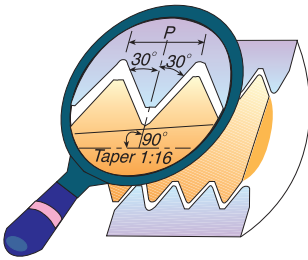

Pitch TPI	L	I.C. in	EXTERNAL Ordering Code		INTERNAL Ordering Code		X	Y
			Right Hand	Left Hand	Right Hand	Left Hand		
27	6	5/32	ULTRA MINIATURE →		*06 IR 27 NPTF	*06 IL 27 NPTF	0.7	0.6
27	8	3/16	MINIATURE →		*08 IR 27 NPTF	*08 IL 27 NPTF	0.6	0.6
18	8	3/16			*08 IR 18 NPTF	*08 IL 18 NPTF	0.6	0.6
27	11	1/4	11 ER 27 NPTF	11 EL 27 NPTF	11 IR 27 NPTF	11 IL 27 NPTF	0.7	0.7
18	11	1/4	11 ER 18 NPTF	11 EL 18 NPTF	11 IR 18 NPTF	11 IL 18 NPTF	0.8	1.0
14	11	1/4	11 ER 14 NPTF	11 EL 14 NPTF	11 IR 14 NPTF	11 IL 14 NPTF	0.8	1.0
27	16	3/8	16 ER 27 NPTF	16 EL 27 NPTF	16 IR 27 NPTF	16 IL 27 NPTF	0.7	0.7
18	16	3/8	16 ER 18 NPTF	16 EL 18 NPTF	16 IR 18 NPTF	16 IL 18 NPTF	0.8	1.0
14	16	3/8	16 ER 14 NPTF	16 EL 14 NPTF	16 IR 14 NPTF	16 IL 14 NPTF	0.9	1.2
11.5	16	3/8	16 ER 11.5 NPTF	16 EL 11.5 NPTF	16 IR 11.5 NPTF	16 IL 11.5 NPTF	1.1	1.5
8	16	3/8	16 ER 8 NPTF	16 EL 8 NPTF	16 IR 8 NPTF	16 IL 8 NPTF	1.3	1.8

Order example: 11 ER 27 NPTF BMA

* Available only in BXC grade

BSPT

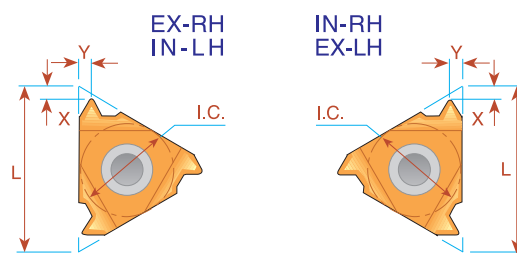
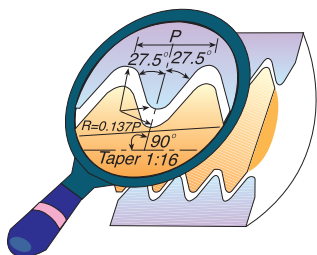

Pitch TPI	L	I.C. in	EXTERNAL Ordering Code		INTERNAL Ordering Code		X	Y
			Right Hand	Left Hand	Right Hand	Left Hand		
28	6	5/32	ULTRA MINIATURE →		* 06 IR 28 BSPT	* 06 IL 28 BSPT	0.7	0.6
28	8	3/16	MINIATURE →		* 08 IR 28 BSPT	* 08 IL 28 BSPT	0.6	0.6
19	8	3/16			* 08 IR 19 BSPT	* 08 IL 19 BSPT	0.6	0.6
28	11	1/4			11 IR 28 BSPT	11 IL 28 BSPT	0.6	0.6
19	11	1/4			11 IR 19 BSPT	11 IL 19 BSPT	0.8	0.9
14	11	1/4			11 IR 14 BSPT	11 IL 14 BSPT	0.9	1.0
11	11	1/4			11 IR 11 BSPT	11 IL 11 BSPT	0.9	1.2
28	16	3/8	16 ER 28 BSPT	16 EL 28 BSPT	16 IR 28 BSPT	16 IL 28 BSPT	0.6	0.6
19	16	3/8	16 ER 19 BSPT	16 EL 19 BSPT	16 IR 19 BSPT	16 IL 19 BSPT	0.8	0.9
14	16	3/8	16 ER 14 BSPT	16 EL 14 BSPT	16 IR 14 BSPT	16 IL 14 BSPT	1.0	1.2
11	16	3/8	16 ER 11 BSPT	16 EL 11 BSPT	16 IR 11 BSPT	16 IL 11 BSPT	1.1	1.5

Order example: 11 IR 14 BSPT BMA

* Available only in BXC grade

Type B

Ground Profile with Sintered Chip-breaker

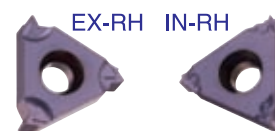

Pitch TPI	L	I.C. in	EXTERNAL Ordering Code		INTERNAL Ordering Code		X	Y
			Right Hand	Right Hand	Right Hand	Right Hand		
19	16	3/8	16 ER B 19 BSPT		16 IR B 14 BSPT		1.0	1.1
14	16	3/8	16 ER B 14 BSPT		16 IR B 11 BSPT		1.2	1.0
11	16	3/8	16 ER B 11 BSPT		16 IR B 11 BSPT		1.5	1.1

Order example: 16 ER B 11 BSPT BMA

BSPT Vertical

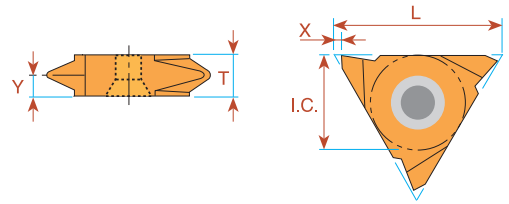

Pitch TPI	L	I.C. in	EXTERNAL Ordering Code				X	Y	T
			Right Hand		Left Hand				
28	16	3/8	16V ER 28 BSPT	BSPT	16V EL 28 BSPT	BSPT	1.0	0.6	3.6
19	16	3/8	16V ER 19 BSPT	BSPT	16V EL 19 BSPT	BSPT	1.0	0.9	3.6
14	16	3/8	16V ER 14 BSPT	BSPT	16V EL 14 BSPT	BSPT	1.0	1.2	3.6
11	16	3/8	16V ER 11 BSPT	BSPT	16V EL 11 BSPT	BSPT	1.0	1.5	3.6

Order example: 16V ER 19 BSPT BMA

Acme

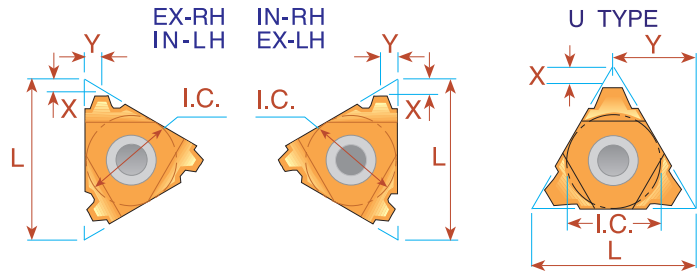
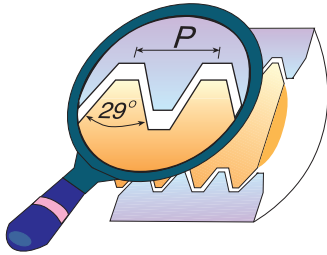

Pitch TPI	L	I.C. in	EXTERNAL Ordering Code		INTERNAL Ordering Code		X	Y
			Right Hand	Left Hand	Right Hand	Left Hand		
16	8	3/16	MINIATURE →		**08 IR 16 ACME	**08 IL 16 ACME	0.6	0.6
14	8U	3/16U	"U" MINIATURE →		*08U IR/L 14 ACME		0.8	4.0
12	8U	3/16U			*08U IR/L 12 ACME		0.8	4.0
10	8U	3/16U			*08U IR/L 10 ACME		0.8	4.0
16	11	1/4	11 ER 16 ACME	11 EL 16 ACME	11 IR 16 ACME	11 IL 16 ACME	0.9	1.0
16	16	3/8	16 ER 16 ACME	16 EL 16 ACME	16 IR 16 ACME	16 IL 16 ACME	0.9	1.0
14	16	3/8	16 ER 14 ACME	16 EL 14 ACME	16 IR 14 ACME	16 IL 14 ACME	1.0	1.2
12	16	3/8	16 ER 12 ACME	16 EL 12 ACME	16 IR 12 ACME	16 IL 12 ACME	1.1	1.2
10	16	3/8	16 ER 10 ACME	16 EL 10 ACME	16 IR 10 ACME	16 IL 10 ACME	1.3	1.3
8	16	3/8	16 ER 8 ACME	16 EL 8 ACME	16 IR 8 ACME	16 IL 8 ACME	1.5	1.5
6	16	3/8	16 ER 6 ACME	16 EL 6 ACME	16 IR 6 ACME	16 IL 6 ACME	1.7	1.8
6	22	1/2	22 ER 6 ACME	22 EL 6 ACME	22 IR 6 ACME	22 IL 6 ACME	1.8	2.1
5	22	1/2	22 ER 5 ACME	22 EL 5 ACME	22 IR 5 ACME	22 IL 5 ACME	2.0	2.3
4	22	1/2	22 ER 4 ACME	22 EL 4 ACME	22 IR 4 ACME	22 IL 4 ACME	2.1	2.2
4	22U	1/2U	22U ER/L 4 ACME		22U IR/L 4 ACME		2.3	11.0
4	27	5/8	27 ER 4 ACME	27 EL 4 ACME	27 IR 4 ACME	27 IL 4 ACME	2.3	2.7
3	27U	5/8U	27U ER/L 3 ACME		27U IR/L 3 ACME		2.8	13.7
2	33U	3/4U	33U ER/L 2 ACME		33U IR/L 2 ACME		4.3	16.9

Order example: 16 ER 16 ACME MXC

For small bore threading see page 178

* Available only in BXC grade

** One cutting edge

ACME Vertical

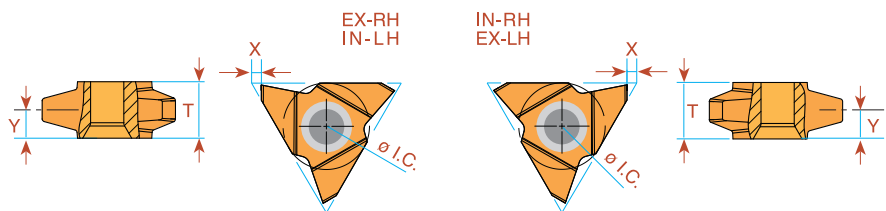

Pitch TPI	L	I.C. in	EXTERNAL Ordering Code		INTERNAL Ordering Code		X	Y	T
			Right Hand	Left Hand	Right Hand	Left Hand			
2	27	5/8	27V ER 2 ACME	27V EL 2 ACME	27V IR 2 ACME	27V IL 2 ACME	1.8	5.2	10.4

Order example: 27V ER 2 ACME BMA

For Carbide Grade and Cutting Speed see page 56

Stub Acme

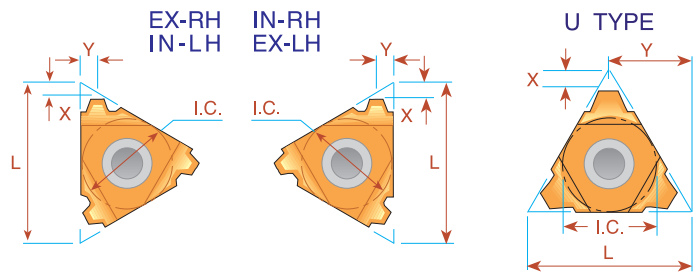
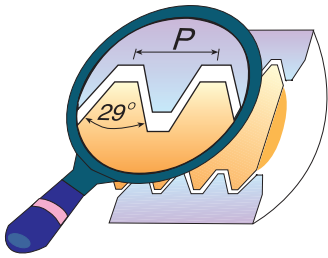

Pitch TPI	L	I.C. in	EXTERNAL Ordering Code		INTERNAL Ordering Code		X	Y
			Right Hand	Left Hand	Right Hand	Left Hand		
16	8	3/16	MINIATURE →		**08 IR16 STACME	**08 IL16 STACME	0.6	0.6
14	8U	3/16U	"U" MINIATURE →		*08U IR/L 14 STACME		0.8	4.0
12	8U	3/16U			*08U IR/L 12 STACME		0.9	4.0
10	8U	3/16U			*08U IR/L 10 STACME		1.0	4.0
16	11	1/4	11 ER 16 STACME	11 EL 16 STACME			1.0	1.0
16	16	3/8	16 ER 16 STACME	16 EL 16 STACME	16 IR 16 STACME	16 IL 16 STACME	1.0	1.0
14	16	3/8	16 ER 14 STACME	16 EL 14 STACME	16 IR 14 STACME	16 IL 14 STACME	1.1	1.1
12	16	3/8	16 ER 12 STACME	16 EL 12 STACME	16 IR 12 STACME	16 IL 12 STACME	1.2	1.2
10	16	3/8	16 ER 10 STACME	16 EL 10 STACME	16 IR 10 STACME	16 IL 10 STACME	1.3	1.3
8	16	3/8	16 ER 8 STACME	16 EL 8 STACME	16 IR 8 STACME	16 IL 8 STACME	1.5	1.5
6	16	3/8	16 ER 6 STACME	16 EL 6 STACME	16 IR 6 STACME	16 IL 6 STACME	1.8	1.8
5	22	1/2	22 ER 5 STACME	22 EL 5 STACME	22 IR 5 STACME	22 IL 5 STACME	2.0	2.3
4	22	1/2	22 ER 4 STACME	22 EL 4 STACME	22 IR 4 STACME	22 IL 4 STACME	2.3	2.4
4	22U	1/2U	22U ER/L 4 STACME		22U IR/L 4 STACME		2.5	11.0
3	22U	1/2U	22U ER/L 3 STACME		22U IR/L 3 STACME		3.3	11.0
4	27	5/8	27 ER 4 STACME	27 EL 4 STACME	27 IR 4 STACME	27 IL 4 STACME	2.3	2.4
3	27	5/8	27 ER 3 STACME	27 EL 3 STACME	27 IR 3 STACME	27 IL 3 STACME	2.8	2.9
2	33U	3/4U	33U ER/L 2 STACME		33U IR/L 2 STACME		5.0	16.9

Order example: 22 IR 5 STACME MXC

* Available only in BXC grade

** One cutting edge

Trapez - DIN 103

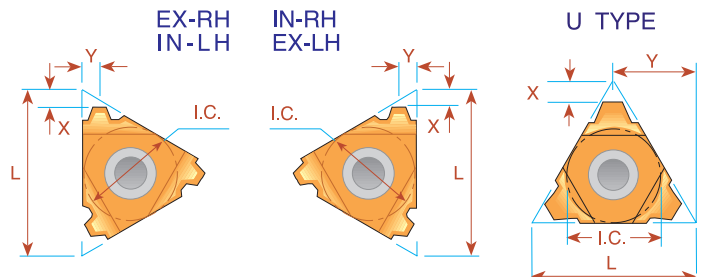
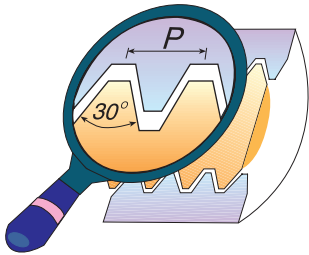

Pitch mm	L mm	I.C.	EXTERNAL Ordering Code		INTERNAL Ordering Code		X	Y
			Right Hand	Left Hand	Right Hand	Left Hand		
1.5	8	3/16	MINIATURE →		**08 IR 1.5 TR	**08 IL 1.5 TR	0.6	0.6
2.0	8U	3/16U	"U" MINIATURE →		*08U IR/L 2 TR		0.9	4.0
1.5	16	3/8	16 ER 1.5 TR	16 EL 1.5 TR	16 IR 2 TR 16 IR 3 TR 16 IR 4 TR	16 IL 2 TR	1.0	1.1
2.0	16	3/8	16 ER 2 TR	16 EL 2 TR		16 IL 2 TR	1.0	1.3
3.0	16	3/8	16 ER 3 TR	16 EL 3 TR		16 IL 3 TR	1.3	1.5
4.0	16	3/8	16 ER 4 TR	16 EL 4 TR		16 IL 4 TR	1.3	1.5
5.0	16	3/8U				***16U IR/L 5 TR		2.3
4.0	22	1/2	22 ER 4 TR	22 EL 4 TR	22 IR 4 TR	22 IL 4 TR	1.8	1.9
5.0	22	1/2	22 ER 5 TR	22 EL 5 TR	22 IR 5 TR	22 IL 5 TR	2.0	2.4
6.0	22	1/2	22 ER 6 TR	22 EL 6 TR	22 IR 6 TR	22 IL 6 TR	2.0	2.4
6.0	22U	1/2U			22U IR/L 6 TR		2.0	11.00
7.0	22U	1/2U	22U ER/L 6 TR		22U IR/L 7 TR		2.3	11.00
7.0	22U	1/2U	22U ER/L 7 TR		*** 22U IR/L 7 TR40		2.6	11.00
8.0	22U	1/2U	22U ER/L 8 TR		22U IR/L 8 TR		2.5	11.00
6.0	27	5/8	27 ER 6 TR	27 EL 6 TR	27 IR 6 TR	27 IL 6 TR	2.3	2.7
7.0	27	5/8	27 ER 7 TR	27 EL 7 TR	27 IR 7 TR	27 IL 7 TR	2.2	2.6
8.0	27U	5/8U	27U ER/L 8 TR		27U IR/L 8 TR		2.5	13.7
9.0	27U	5/8U	27U ER/L 9 TR		27U IR/L 9 TR		3.0	13.7
10.0	27U	5/8U	**27U ER/L 10 TR		** 27U IR/L 10 TR		3.2	13.7
12.0	33U	3/4U	33U ER/L 12 TR		33U IR/L 12 TR		3.9	16.9

Order example: 22 IR 5 TR MXC

* Available only in BXC grade

** One cutting edge

*** To be used only with holder SIR/L0014M16UB on page 48

**** To be used only with holder SIR/L0025S22UB -TR40x7 on page 48

Trapez - DIN 103 Vertical

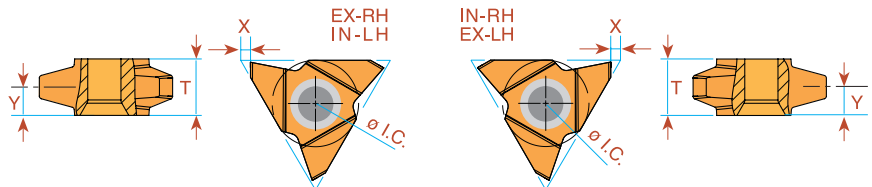

Pitch mm	L	I.C. in	EXTERNAL Ordering Code		INTERNAL Ordering Code		X	Y	T
			Right Hand	Left Hand	Right Hand	Left Hand			
9	27	5/8	27V ER 9 TR	27V EL 9 TR	27V IR 9 TR	27V IL 9 TR	1.8	5.2	10.4
10	27	5/8	27V ER 10 TR	27V EL 10 TR	27V IR 10 TR	27V IL 10 TR	1.8	5.2	10.4
12	27	5/8	27V ER 12 TR	27V EL 12 TR	27V IR 12 TR	27V IL 12 TR	1.8	5.2	10.4

Order example: 27V ER 12 TR BMA

For Carbide Grade and Cutting Speed see page 56

PG - DIN 40430

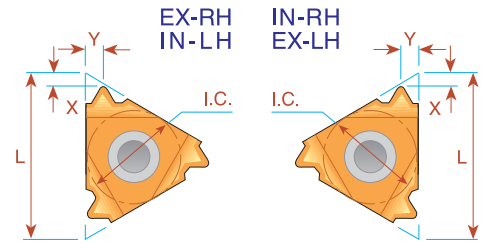
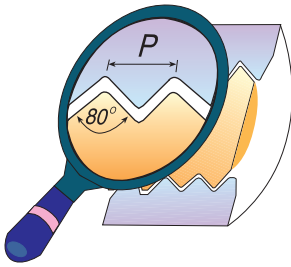

Pitch TPI	L	I.C. in	EXTERNAL Ordering Code		INTERNAL Ordering Code		X	Y
			Right Hand	Standard	Right Hand	Standard		
20	8	3/16	<i>MINIATURE</i> →		*08 IR 20 PG	(PG 7)	0.6	0.7
18	11	1/4			11 IR 18 PG	(PG 9)	0.8	0.9
20	16	3/8	16 ER 20 PG	(PG 7)			0.7	0.8
18	16	3/8	16 ER 18 PG	(PG 9,11,13.5, 16)	16 IR 18 PG	(PG 11,13.5, 16)	0.8	0.9
16	16	3/8	16 ER 16 PG	(PG 21, 29, 36, 42, 48)	16 IR 16 PG	(PG 21, 29, 36, 42, 48)	0.8	1.0

Order example: 16 ER 16 PG BMA

* Available only in BXC grade

Sagengewinde - DIN 513

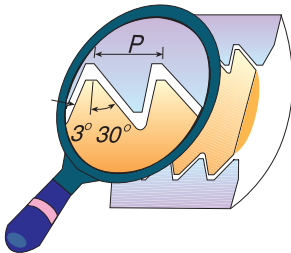

IMPORTANT NOTE:
In Carmex standard execution, the flank with the large angle is the leading edge. If otherwise required, please specify in your order.

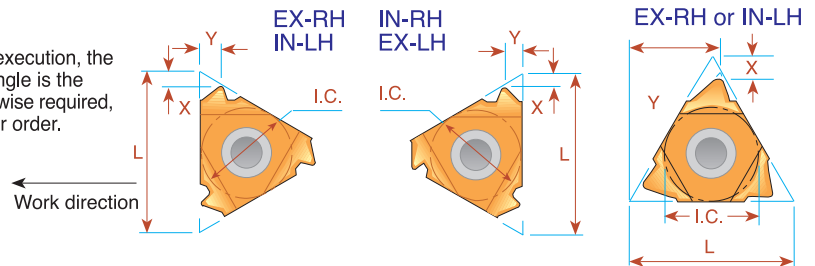

Pitch mm	L	I.C. in	EXTERNAL Ordering Code		X	Y	INTERNAL Ordering Code		X	Y
			Right Hand	Left Hand			Right Hand	Left Hand		
2.0	16	3/8	16 ER 2 SAGE	16 EL 2 SAGE	1.1	1.6	16 IR 2 SAGE	16 IL 2 SAGE	1.2	1.7
3.0	22	1/2	22 ER 3 SAGE	22 EL 3 SAGE	1.5	2.4	22 IR 3 SAGE	22 IL 3 SAGE	1.9	2.9
4.0	22	1/2	22 ER 4 SAGE	22 EL 4 SAGE	1.9	3.1	22 IR 4 SAGE	22 IL 4 SAGE	2.3	3.5
* 5.0	22U	1/2U	22U ER 5 SAGE	22U EL 5 SAGE	1.2	11.6	22U IR 5 SAGE	22U IL 5 SAGE	1.9	11.7
* 6.0	22U	1/2U	22U ER 6 SAGE	22U EL 6 SAGE	1.2	11.7	22U IR 6 SAGE	22U IL 6 SAGE	2.1	11.9

Order example: 22 IR 4 SAGE BMA

* Requires a special anvil

Round - DIN 405

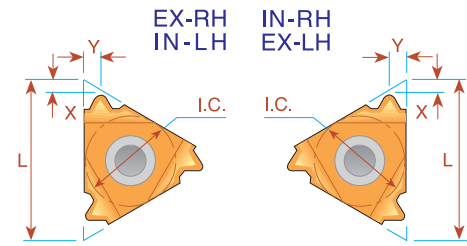
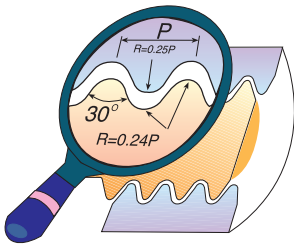

Pitch TPI	L	I.C. in	EXTERNAL Ordering Code		X	Y	INTERNAL Ordering Code		X	Y
			Right Hand	Left Hand			Right Hand	Left Hand		
10	16	3/8	16 ER 10 RD	16 EL 10 RD	1.1	1.2	16 IR 10 RD	16 IL 10 RD	1.1	1.2
8	16	3/8	16 ER 8 RD	16 EL 8 RD	1.4	1.3	16 IR 8 RD	16 IL 8 RD	1.4	1.4
6	16	3/8	16 ER 6 RD	16 EL 6 RD	1.5	1.7	16 IR 6 RD	16 IL 6 RD	1.4	1.5
6	22	1/2	22 ER 6 RD	22 EL 6 RD	1.5	1.7	22 IR 6 RD	22 IL 6 RD	1.5	1.7
4	22	1/2	22 ER 4 RD	22 EL 4 RD	2.2	2.3	22 IR 4 RD	22 IL 4 RD	2.2	2.3
4	27	5/8	27 ER 4 RD	27 EL 4 RD	2.2	2.3	27 IR 4 RD	27 IL 4 RD	2.2	2.3

Order example: 27 IL 4 RD BMA

Round - DIN 20400

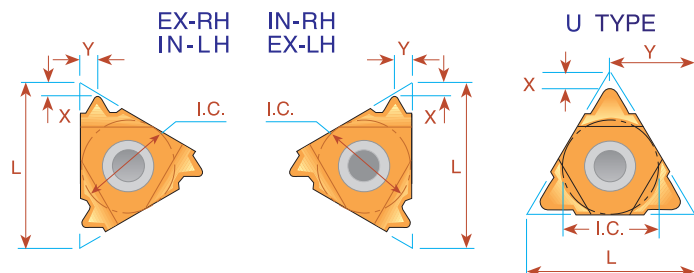
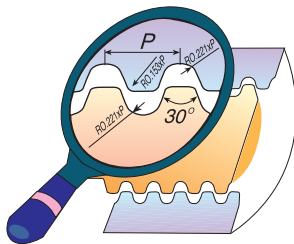

Pitch mm	L	I.C. in	EXTERNAL Ordering Code Right Hand	INTERNAL Ordering Code Right Hand	X	Y
			4.0	22		
5.0	22	1/2	22 ER 5.0 RD 20400	22 IR 5.0 RD 20400	1.7	1.8
6.0	22	1/2	22 ER 6.0 RD 20400	22 IR 6.0 RD 20400	1.7	2.0
8.0	27U	5/8U	* 27U - 8.0 RD 20400		3.0	13.7
10.0	27U	5/8U	* 27U-10.0 RD 20400		3.4	13.7

Order example: 22 ER 4.0 RD 20400 MXC

* Same insert for Internal and External Right Hand Thread

UNJ UNJC, UNJF, UNJEF, UNJS

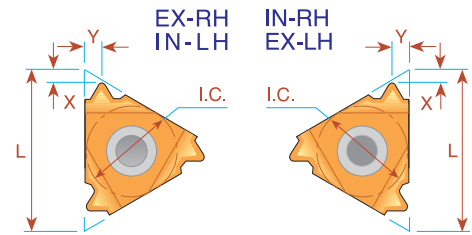
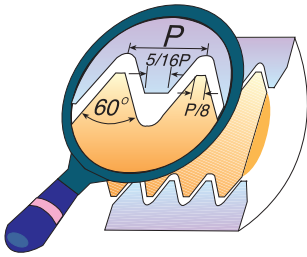

Pitch TPI	L	I.C. in	EXTERNAL Ordering Code		INTERNAL Ordering Code		X	Y
			Right Hand	Left Hand	Right Hand	Left Hand		
48	11	1/4	11 ER 48 UNJ	11 EL 48 UNJ	11 IR 48 UNJ	11 IL 48 UNJ	0.6	0.6
44	11	1/4	11 ER 44 UNJ	11 EL 44 UNJ	11 IR 44 UNJ	11 IL 44 UNJ	0.6	0.6
40	11	1/4	11 ER 40 UNJ	11 EL 40 UNJ	11 IR 40 UNJ	11 IL 40 UNJ	0.6	0.6
36	11	1/4	11 ER 36 UNJ	11 EL 36 UNJ	11 IR 36 UNJ	11 IL 36 UNJ	0.6	0.6
32	11	1/4	11 ER 32 UNJ	11 EL 32 UNJ	11 IR 32 UNJ	11 IL 32 UNJ	0.6	0.6
28	11	1/4	11 ER 28 UNJ	11 EL 28 UNJ	11 IR 28 UNJ	11 IL 28 UNJ	0.6	0.6
24	11	1/4	11 ER 24 UNJ	11 EL 24 UNJ	11 IR 24 UNJ	11 IL 24 UNJ	0.7	0.8
20	11	1/4	11 ER 20 UNJ	11 EL 20 UNJ	11 IR 20 UNJ	11 IL 20 UNJ	0.8	0.9
18	11	1/4	11 ER 18 UNJ	11 EL 18 UNJ	11 IR 18 UNJ	11 IL 18 UNJ	0.8	1.0
16	11	1/4	11 ER 16 UNJ	11 EL 16 UNJ	11 IR 16 UNJ	11 IL 16 UNJ	0.8	1.0
14	11	1/4	11 ER 14 UNJ	11 EL 14 UNJ	11 IR 14 UNJ	11 IL 14 UNJ	0.9	1.0
48	16	3/8	16 ER 48 UNJ	16 EL 48 UNJ	16 IR 48 UNJ	16 IL 48 UNJ	0.6	0.6
44	16	3/8	16 ER 44 UNJ	16 EL 44 UNJ	16 IR 44 UNJ	16 IL 44 UNJ	0.6	0.6
40	16	3/8	16 ER 40 UNJ	16 EL 40 UNJ	16 IR 40 UNJ	16 IL 40 UNJ	0.6	0.6
36	16	3/8	16 ER 36 UNJ	16 EL 36 UNJ	16 IR 36 UNJ	16 IL 36 UNJ	0.6	0.6
32	16	3/8	16 ER 32 UNJ	16 EL 32 UNJ	16 IR 32 UNJ	16 IL 32 UNJ	0.6	0.6
28	16	3/8	16 ER 28 UNJ	16 EL 28 UNJ	16 IR 28 UNJ	16 IL 28 UNJ	0.6	0.6
24	16	3/8	16 ER 24 UNJ	16 EL 24 UNJ	16 IR 24 UNJ	16 IL 24 UNJ	0.7	0.8
20	16	3/8	16 ER 20 UNJ	16 EL 20 UNJ	16 IR 20 UNJ	16 IL 20 UNJ	0.8	0.9
18	16	3/8	16 ER 18 UNJ	16 EL 18 UNJ	16 IR 18 UNJ	16 IL 18 UNJ	0.8	1.0
16	16	3/8	16 ER 16 UNJ	16 EL 16 UNJ	16 IR 16 UNJ	16 IL 16 UNJ	0.8	1.0
14	16	3/8	16 ER 14 UNJ	16 EL 14 UNJ	16 IR 14 UNJ	16 IL 14 UNJ	1.0	1.2
13	16	3/8	16 ER 13 UNJ	16 EL 13 UNJ	16 IR 13 UNJ	16 IL 13 UNJ	1.0	1.3
12	16	3/8	16 ER 12 UNJ	16 EL 12 UNJ	16 IR 12 UNJ	16 IL 12 UNJ	1.1	1.4
11	16	3/8	16 ER 11 UNJ	16 EL 11 UNJ	16 IR 11 UNJ	16 IL 11 UNJ	1.1	1.5
10	16	3/8	16 ER 10 UNJ	16 EL 10 UNJ	16 IR 10 UNJ	16 IL 10 UNJ	1.1	1.5
9	16	3/8	16 ER 9 UNJ	16 EL 9 UNJ	16 IR 9 UNJ	16 IL 9 UNJ	1.2	1.6
8	16	3/8	16 ER 8 UNJ	16 EL 8 UNJ	16 IR 8 UNJ	16 IL 8 UNJ	1.2	1.6

Order example: 16 IR 16 UNJ MXC

MJ - ISO 5855

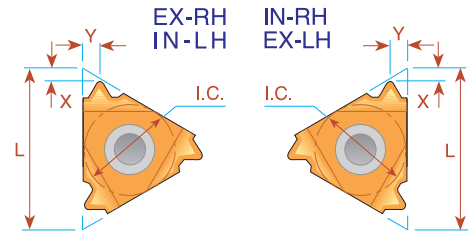
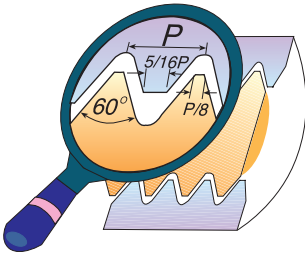

Pitch mm	L	I.C. in	EXTERNAL		INTERNAL		X	Y
			Ordering Code	Right Hand	Ordering Code	Right Hand		
1.0	11	1/4			11 IR 1.0 MJ		0.7	0.8
1.25	11	1/4			11 IR 1.25MJ		0.8	0.9
1.5	11	1/4			11 IR 1.5 MJ		0.8	1.0
2.0	11	1/4			11 IR 2.0 MJ		0.9	1.0
1.0	16	3/8		16 ER 1.0 MJ		16 IR 1.0 MJ	0.7	0.8
1.25	16	3/8		16 ER 1.25MJ		16 IR 1.25MJ	0.8	0.9
1.5	16	3/8		16 ER 1.5 MJ		16 IR 1.5 MJ	0.8	1.0
2.0	16	3/8		16 ER 2.0 MJ		16 IR 2.0 MJ	1.0	1.3

Order example: 16 ER 1.5 MJ BMA

American Buttress

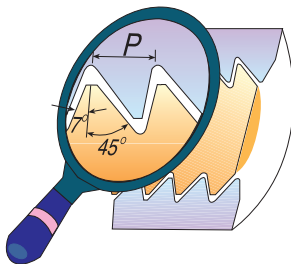

IMPORTANT NOTE:
In Carmex standard execution, the flank with the large angle is the leading edge. If otherwise required, please specify in your order.

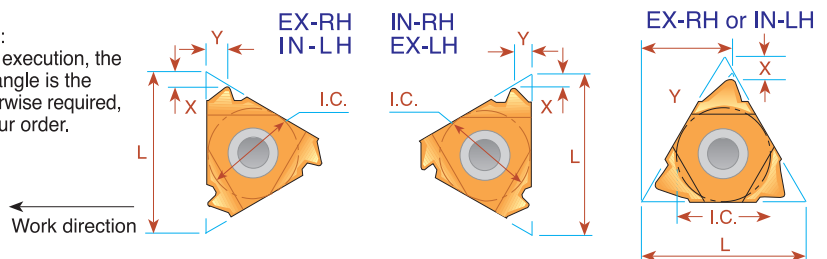

Pitch TPI	L	I.C. in	EXTERNAL		INTERNAL		X	Y
			Ordering Code	Right Hand	Ordering Code	Left Hand		
20	11	1/4	11 ER 20 ABUT	11 EL 20 ABUT	11 IR 20 ABUT	11 IL 20 ABUT	1.0	1.3
16	11	1/4	11 ER 16 ABUT	11 EL 16 ABUT	11 IR 16 ABUT	11 IL 16 ABUT	1.0	1.5
20	16	3/8	16 ER 20 ABUT	16 EL 20 ABUT	16 IR 20 ABUT	16 IL 20 ABUT	1.0	1.3
16	16	3/8	16 ER 16 ABUT	16 EL 16 ABUT	16 IR 16 ABUT	16 IL 16 ABUT	1.0	1.5
12	16	3/8	16 ER 12 ABUT	16 EL 12 ABUT	16 IR 12 ABUT	16 IL 12 ABUT	1.4	2.0
10	16	3/8	16 ER 10 ABUT	16 EL 10 ABUT	16 IR 10 ABUT	16 IL 10 ABUT	1.5	2.3
8	22	1/2	22 ER 8 ABUT	22 EL 8 ABUT	22 IR 8 ABUT	22 IL 8 ABUT	2.1	3.3
6	22	1/2	22 ER 6 ABUT	22 EL 6 ABUT	22 IR 6 ABUT	22 IL 6 ABUT	2.1	3.4
4	22U	1/2U	22U ER 4 ABUT	22U EL 4 ABUT	22U IR 4 ABUT	22U IL 4 ABUT	2.3	9.5
3	27U	5/8U	27U ER 3 ABUT	27U EL 3 ABUT	27U IR 3 ABUT	27U IL 3 ABUT	3.1	11.7

Order example: 16 IL 12 ABUT MXC

For Carbide Grade and Cutting Speed see page 56

OIL Threads API Round

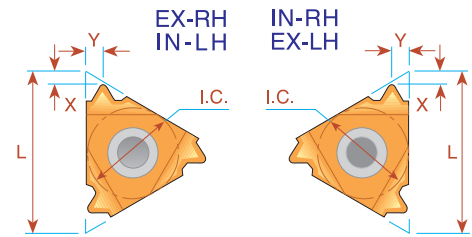
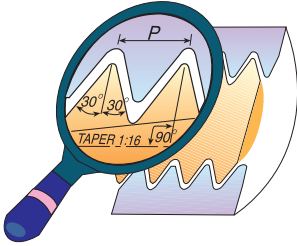

Pitch TPI	L	I.C. in	Taper IPF	EXTERNAL Ordering Code	INTERNAL Ordering Code	X	Y
10	16	3/8	0.75	16 ER 10 API RD	16 IR 10 API RD	1.5	1.4
8	16	3/8	0.75	16 ER 8 API RD	16 IR 8 API RD	1.3	1.6

Order example: 16 ER 10 API RD BMA

Multitooth

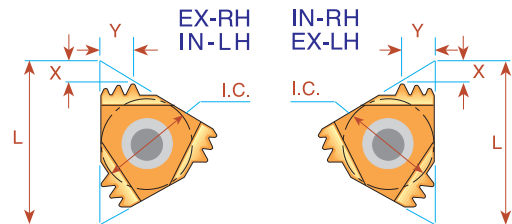
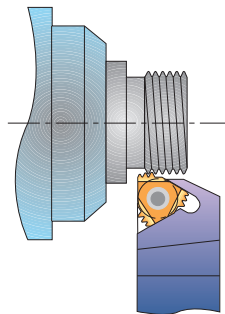

Pitch TPI	L	I.C. in	Number of Teeth	EXTERNAL Ordering Code	Anvil	INTERNAL Ordering Code	Anvil	X	Y
10	22	1/2	2	22 ER 10API RD 2M	AE22M	22 IR 10API RD 2M	AI22M	2.4	3.7
10	27	5/8	3	27 ER 10API RD 3M	AE27M	27 IR 10API RD 3M	AI27M	3.8	6.2
8	27	5/8	2	27 ER 8 API RD 2M	AE27M	27 IR 8 API RD 2M	AI27M	3.0	4.5

Order example: 27 IR 10 API RD 3M MXC

For recommended number of passes see page 57

OIL Threads

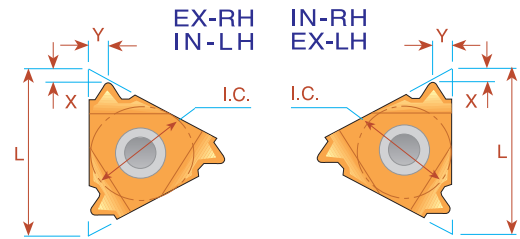
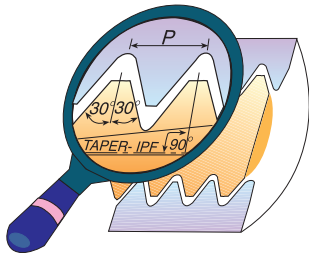

V-0.040

Pitch TPI	L	I.C. in	Taper IPF	EXTERNAL Ordering Code	INTERNAL Ordering Code	X	Y	Connection No. or Size
5	22	1/2	3	22 ER 5 API 403	22 IR 5 API 403	1.8	2.5	2 ³ / ₈ -4 ¹ / ₂ REG

V-0.038R

Pitch TPI	L	I.C. in	Taper IPF	EXTERNAL Ordering Code	INTERNAL Ordering Code	X	Y	Connection No. or Size
4	27	5/8	2	27 ER 4 API 382	27 IR 4 API 382	2.1	2.8	NC23-NC50
4	27	5/8	3	27 ER 4 API 383	27 IR 4 API 383	2.1	2.8	NC56-NC77

V-0.050

Pitch TPI	L	I.C. in	Taper IPF	EXTERNAL Ordering Code	INTERNAL Ordering Code	X	Y	Connection No. or Size
4	27	5/8	2	27 ER 4 API 502	27 IR 4 API 502	2.0	3.0	6 ⁵ / ₈ REG
4	27	5/8	3	27 ER 4 API 503	27 IR 4 API 503	2.0	3.0	5 ¹ / ₂ , 7 ⁵ / ₈ , 8 ⁵ / ₈ , REG

OIL Threads Extreme - Line Casing

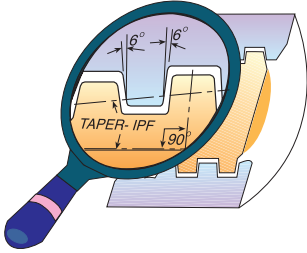

Pitch TPI	L	I.C. in	Taper IPF	EXTERNAL Ordering Code	INTERNAL Ordering Code	X	Y	Connection No. or Size
6	22	1/2	1.50	22 ER 6 EL 1.5	22 IR 6 EL 1.5	1.9	1.9	5-7 ⁵ / ₈
5	22	1/2	1.25	22 ER 5 EL 1.25	22 IR 5 EL 1.25	2.4	2.3	8 ⁵ / ₈ -10 ³ / ₄

Buttress Casing

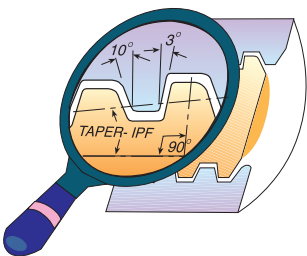

Pitch TPI	L	I.C. in	Taper IPF	EXTERNAL Ordering Code	INTERNAL Ordering Code	X	Y	Connection No. or Size
5	22	1/2	0.75	22 ER 5 BUT 0.75	22 IR 5 BUT 0.75	2.2	2.4	4 ¹ / ₂ -13 ³ / ₈
5	22	1/2	1.00	22 ER 5 BUT 1.0	22 IR 5 BUT 1.0	2.3	2.4	16-20

Order example: 22 ER 5 BUT 0.75 MXC

Thread Turning Inserts

VAM

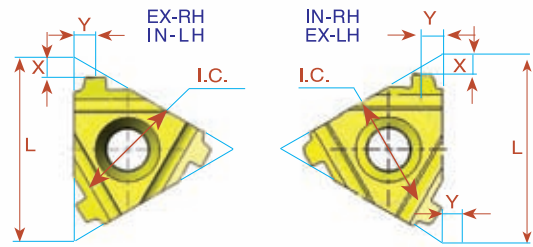
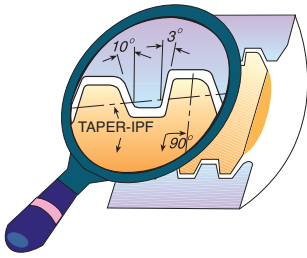

Pitch TPI	L	I.C. in	Taper IPF	EXTERNAL Ordering Code Right Hand	X	Y	INTERNAL Ordering Code Right Hand	X	Y	Connection No. or Size
8	16	3/8	0.75	16 ER 8 VAM	1.7	1.8	16 IR 8 VAM	1.7	1.8	2 3/8" - 2 7/8"
6	22	1/2	0.75	22 ER 6 VAM	2.4	2.4	22 IR 6 VAM	2.5	2.5	3 1/2" - 4 1/2"
5	22	1/2	0.75	22 ER 5 VAM	2.4	2.7	22 IR 5 VAM	2.4	2.5	5" - 13 3/8"

Order Example: 16 ER 8 VAM BMA



Thread Turning Toolholders and Kits



Toolholders Contents:

Product Identification	38
External Toolholders	39
External Toolholders with Top Clamp	40
Vertical Toolholders	40
Slim Throat Toolholders	40
Internal Toolholders	41
Internal Toolholders with Coolant Bore	42
Internal Toolholders with Top Clamp	42
Toolholders with 3.5° Helix Angle	42
Carbide Shank Boring Bars	43
Vertical Toolholders	43
Drophead Toolholders	44

Page:

Kits Contents:

Gang Toolholders	44
Standard Kits	45
Type B Kits	45
Miniature & Ultra-miniature Kits	46
Threading & Boring Combination Kit	46
Anvils and Anvil Kits	47-48
Special Thread Turning Applications	48

Page:

Product Identification

Threading Toolholders Ordering Codes

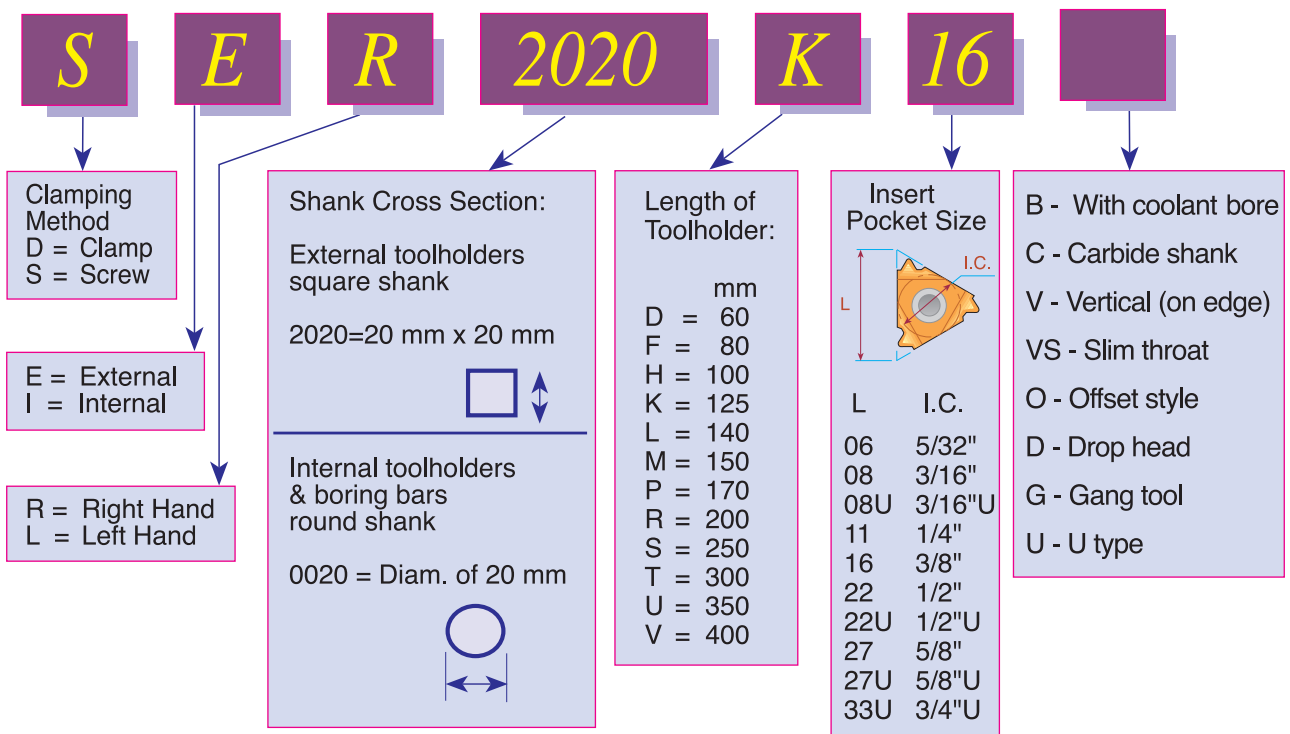

External Toolholders

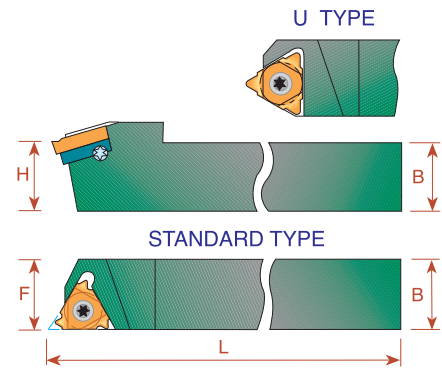
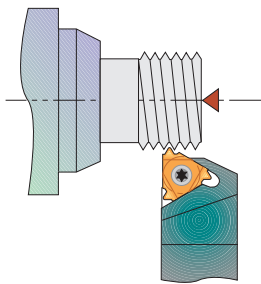

Ordering Code Right Hand		B = H	L	F	Insert Screw	Anvil Screw	Torx Key	RH Anvil	LH Anvil
* SER 8 8 H11	11	8	100	11	S11	-	K11	-	-
* SER 10 10 H11	11	10	100	11	S11	-	K11	-	-
* SER 10 10 M11	11	10	150	11	S11	-	K11	-	-
* SER 12 12 K11	11	12	125	12	S11	-	K11	-	-
* SER 12 12 M11	11	12	150	12	S11	-	K11	-	-
SER 12 12 F16	16	12	80	16	S16	A16	K16	AE16	AI16
SER 16 16 H16	16	16	100	16	S16	A16	K16	AE16	AI16
SER 20 20 K16	16	20	125	20	S16	A16	K16	AE16	AI16
SER 25 25 M16	16	25	150	25	S16	A16	K16	AE16	AI16
SER 32 32 P16	16	32	170	32	S16	A16	K16	AE16	AI16
SER 25 25 M22	22	25	150	25	S22	A22	K22	AE22	AI22
SER 32 32 P22	22	32	170	32	S22	A22	K22	AE22U	AI22U
SER 40 40 R22	22	40	200	40	S22	A22	K22	AE22U	AI22U
SER 25 25 M22U	22U	25	150	28	S22	A22	K22	AE22U	AI22U
SER 32 32 P22U	22U	32	170	32	S22	A22	K22	AE22	AI22
SER 40 40 R22U	22U	40	200	40	S22	A22	K22	AE22	AI22
SER 25 25 M27	27	25	150	32	S27	A27	K27	AE27	AI27
SER 32 32 P27	27	32	170	32	S27	A27	K27	AE27U	AI27U
SER 40 40 R27	27	40	200	40	S27	A27	K27	AE27U	AI27U
SER 25 25 M27U	27U	25	150	32	S27	A27	K27	AE27U	AI27U
SER 32 32 P27U	27U	32	170	32	S27	A27	K27	AE27	AI27
SER 40 40 R27U	27U	40	200	40	S27	A27	K27	AE27	AI27
* SER 25 25 M33U	33U	25	150	32	S33	-	K33	-	-
* SER 32 32 P33U	33U	32	170	32	S33	-	K33	-	-

* Toolholders with no anvil

For **LEFT HAND** toolholders specify **SEL** instead of **SER**

Toolholders are made with a **1.5° Helix Angle**. For other Helix Angles please consult helix angle chart in the technical section of this catalogue.

External toolholders with top clamp

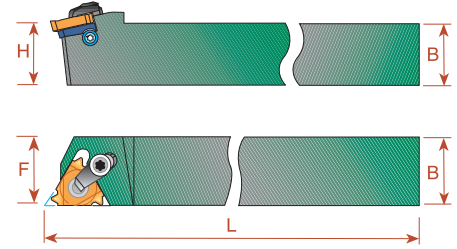

Ordering Code Right Hand		B=H	L	F	Insert Screw	Clamp	Anvil Screw	Torx Key	RH Anvil	LH Anvil
DER 1212 H16	16	12	100	16	S16	C16	A16S	K16	AE16	AI16
DER 1616 H16	16	16	100	16	S16	C16	A16S	K16	AE16	AI16
DER 2020 K16	16	20	125	20	S16	C16	A16S	K16	AE16	AI16
DER 2525 M16	16	25	150	25	S16	C16	A16S	K16	AE16	AI16
* DER 2525 M22	22	25	150	25	S22	C22	A22	K22	AE22	AI22

Toolholders are made with a **1.5° Helix Angle**. For other Helix Angles please consult helix angle chart in the technical section of this catalogue.

Two clamping methods can be used: screw or top clamp.

* Use K21 torx key with C22 clamp

Vertical toolholders

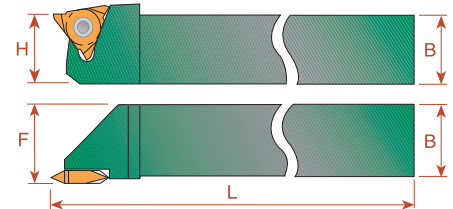
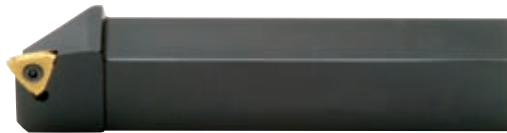

Ordering Code Right Hand		B=H	L	F	Insert Screw	Torx Key
SER 1616 H16V	16	16	100	18	S16S	K16
SER 2020 K16V	16	20	125	22	S16S	K16
SER 2525 M16V	16	25	150	27	S16S	K16
SER 2525 M22V	22	25	150	27.5	S22S	K22
SER 3232 P27V-T10	27	32	170	36	S27S	K27

Slim Throat toolholders

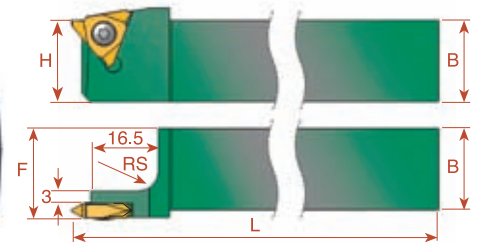

Ordering Code Right Hand		B=H	L	F	Insert Screw	Torx Key
SER 1616 H16VS	16	16	100	18	S16S	K16
SER 2020 K16VS	16	20	125	22	S16S	K16
SER 2525 M16VS	16	25	150	27	S16S	K16

Internal Toolholders

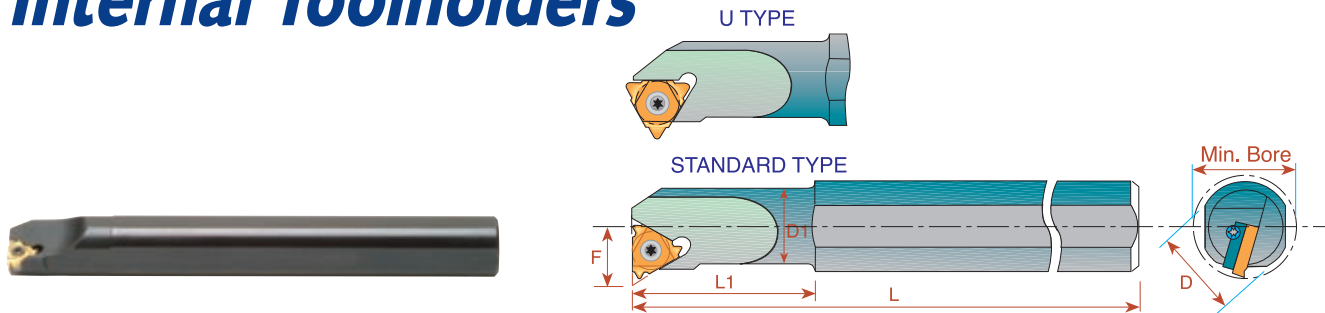

Ordering Code Right Hand		D	D1	Min Bore Diam.	L	L1	F	Insert Screw	Anvil Screw	Torx Key	RH Anvil	LH Anvil
* SIR 0005 H06	6	12	5.1	6.0	100	12	4.3	S06	-	K06	-	-
* SIR 0007 K08	8	16	6.6	7.8	125	18	5.3	S08	-	K08	-	-
* SIR 0008 K08U	8U	16	7.3	9.0	125	21	6.6	S08	-	K08	-	-
* SIR 0010 H11	11	10	10	12	100	-	7.4	S11	-	K11	-	-
* SIR 0010 K11	11	16	10	12	125	25	7.4	S11	-	K11	-	-
* SIR 0013 L11	11	16	13	15	140	32	8.9	S11	-	K11	-	-
* SIR 0013 M16	16	16	13	16	150	32	10.2	S16S	-	K16	-	-
* SIR 0016 P16	16	20	16	19	170	40	11.7	S16S	-	K16	-	-
SIR 0020 P16	16	20	20	24	170	-	13.7	S16	A16	K16	AI16	AE16
SIR 0025 R16	16	25	25	29	200	-	16.2	S16	A16	K16	AI16	AE16
SIR 0032 S16	16	32	32	36	250	-	19.7	S16	A16	K16	AI16	AE16
SIR 0040 T16	16	40	40	44	300	-	23.7	S16	A16	K16	AI16	AE16
SIR 0050 U16	16	50	50	54	350	-	28.7	S16	A16	K16	AI16	AE16
* SIR 0020 P22	22	20	20	24	170	-	15.6	S22S	-	K22	-	-
SIR 0025 R22	22	25	25	29	200	-	18.1	S22	A22	K22	AI22	AE22
SIR 0032 S22	22	32	32	38	250	-	21.6	S22	A22	K22	AI22	AE22
SIR 0040 T22	22	40	40	46	300	-	25.6	S22	A22	K22	AI22	AE22
SIR 0050 U22	22	50	50	56	350	-	30.6	S22	A22	K22	AI22	AE22
SIR 0032 S22U	22U	32	32	38	250	-	24.4	S22	A22	K22	AI22U	AE22U
SIR 0040 T22U	22U	40	40	46	300	-	28.1	S22	A22	K22	AI22U	AE22U
SIR 0050 U22U	22U	50	50	57	350	-	30.8	S22	A22	K22	AI22U	AE22U
SIR 0032 S27	27	32	32	40	250	-	22.6	S27	A27	K27	AI27	AE27
SIR 0040 T27	27	40	40	48	300	-	26.6	S27	A27	K27	AI27	AE27
SIR 0050 U27	27	50	50	58	350	-	31.6	S27	A27	K27	AI27	AE27
SIR 0060 V27	27	60	60	68	400	-	36.6	S27	A27	K27	AI27	AE27
SIR 0032 S27U	27U	32	32	40	250	-	25.8	S27	A27	K27	AI27U	AE27U
SIR 0040 T27U	27U	40	40	48	300	-	29.4	S27	A27	K27	AI27U	AE27U
SIR 0050 U27U	27U	50	50	58	350	-	34.3	S27	A27	K27	AI27U	AE27U
SIR 0060 V27U	27U	60	60	68	400	-	39.7	S27	A27	K27	AI27U	AE27U
SIR 0050 U33U	33U	50	50	62	350	-	37.5	S33	-	K33	-	-

* Toolholders with no anvil.

For **LEFT HAND** toolholders specify **SIL** instead of **SIR**

Toolholders are made with a **1.5° Helix Angle**. For other Helix Angles please consult Helix Angle chart in the technical section of this catalogue.

Internal toolholders with coolant bore

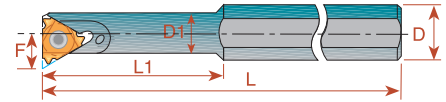

Ordering Code Right Hand		D	D1	Min Bore Diam.	L	L1	F	Insert Screw	Anvil Screw	Torx Key	RH Anvil	LH Anvil
* SIR 0010 K11B	11	16	10	12	125	25	7.4	S11	-	K11	-	-
* SIR 0013 M16B	16	16	13	16	150	32	10.2	S16S	-	K16	-	-
* SIR 0016 P16B	16	20	16	19	170	40	11.7	S16S	-	K16	-	-
SIR 0020 P16B	16	20	20	24	170	-	13.7	S16	A16	K16	AI16	AE16
SIR 0025 R16B	16	25	25	29	200	-	16.2	S16	A16	K16	AI16	AE16
SIR 0032 S16B	16	32	32	36	250	-	19.7	S16	A16	K16	AI16	AE16
SIR 0025 R22B	22	25	25	29	200	-	18.1	S22	A22	K22	AI22	AE22

* Toolholders with no anvil

For **LEFT HAND** toolholders specify **SIL** instead of **SIR**

Toolholders are made with a **1.5° Helix Angle**. For other Helix Angles please consult helix angle chart in the technical section of this catalogue.

Internal toolholders with top clamp

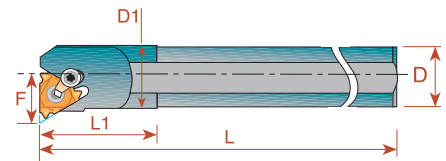

Ordering Code Right Hand		D	D1	Min Bore Diam.	L	L1	F	Insert Screw	Clamp	Anvil Screw	Torx Key	RH Anvil	LH Anvil
DIR 0020 P16	16	20	20	24	170	-	13.7	S16	C16	A16S	K16	AI16	AE16
DIR 0025 R16	16	25	25	29	200	-	16.2	S16	C16	A16S	K16	AI16	AE16
DIR 0032 S16	16	32	32	36	250	-	19.7	S16	C16	A16S	K16	AI16	AE16
* DIR 0025 R22	22	25	25	29	200	-	18.1	S22	C22	A22	K22	AI22	AE22

For **LEFT HAND** toolholders specify **DIL** instead of **DIR**

Two clamping methods can be used: screw or top clamp

* Use K21 torx key with C22 clamp

Toolholders with 3.5° Helix Angle

Ordering Code Right Hand		D	D1	Min Bore Diam.	L	L1	F	Insert Screw	Torx Key
SIR 0016 P16B-3.5	16	20	16	19	170	40	13.7	S16S	K16
SIR 0020 P22B-3.5	22	20	20	24	170	-	15.6	S22S	K22

For **LEFT HAND** toolholders specify **SIL** instead of **SIR**

Carbide Shank Boring Bars With coolant bore

Carbide Shank Boring Bars are used when chatter and deflection are expected due to long overhang in deep small bores.

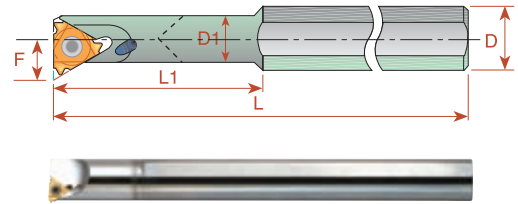



Ordering Code Right Hand		D	D1	Min Bore Diam.	L	L1	F	Insert Screw	Anvil Screw	Torx Key	RH Anvil	LH Anvil
SIR 0005 H06CB	6	6	5.1	6.0	100	26	4.3	S06	-	K06	-	-
SIR 0007 K08CB	8	8	6.6	7.8	125	31	5.3	S08	-	K08	-	-
SIR 0008 K08UCB	8U	8	7.3	9.0	125	35	6.6	S08	-	K08	-	-
SIR 0010 M11CB	11	10	10	12	150	-	7.4	S11	-	K11	-	-
SIR 0012 P11CB	11	12	12	15	170	-	8.4	S11	-	K11	-	-
SIR 0016 R16CB	16	16	16	19	200	-	11.7	S16S	-	K16	-	-
* SIR 0020 S16CB	16	20	20	23	250	-	13.7	S16	A16	K16	Al16	AE16
* SIR 0025 S16CB	16	25	25	28	250	-	16.2	S16	A16	K16	Al16	AE16
SIR 0020 S22CB	22	20	20	24.5	250	-	15.6	S22	-	K22	-	-

* Carbide shank boring bars with anvils

For **LEFT HAND** toolholders specify **SIL** instead of **SIR**

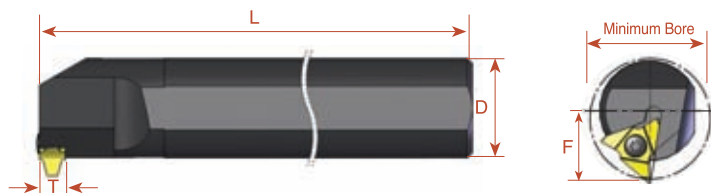
Vertical Toolholder



Ordering Code Right Hand		D	Min Bore Diam.	L	F	Insert Screw	Torx Key
SIR 0040 T27V T10	27	40	48	300	29	S27	K27
SIR 0050 T27V T10	27	50	58	350	34	S27	K27

For **LEFT HAND** toolholders specify **SIL** instead of **SIR**

Drophead Toolholders

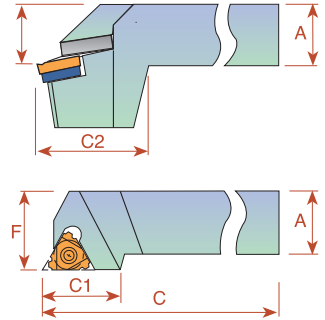

Ordering Code Right Hand		A	A1	C	C1	F	C2	Insert Screw	Anvil Screw	Torx Key	RH Anvil	LH Anvil
SER 2020 K16D	16	20	20	125	21.0	25	38	S16	A16	K16	AE16	AI16
SER 2525 M16D	16	25	25	150	21.0	32	38	S16	A16	K16	AE16	AI16
SER 2525 M22D	22	25	25	150	25.0	32	38	S22	A22	K22	AE22	AI22

Gang Toolholders

Gang Toolholders are External Holders, used in small automatic machines with a gang tool post

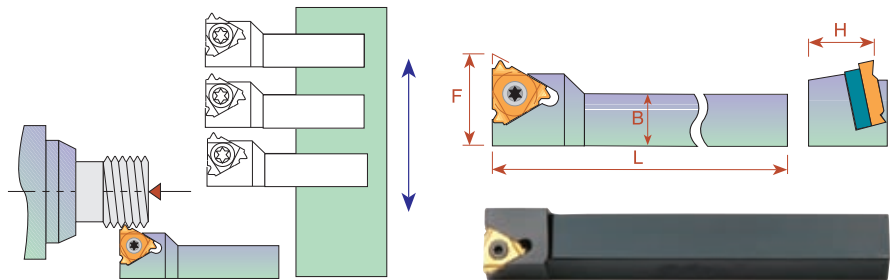

Ordering Code Right Hand		B = H	L	F	Insert Screw	Anvil Screw	Torx Key	RH Anvil	LH Anvil
* SER 8 8 H11G	11	8	100	12.0	S11	-	K11	-	-
* SER 10 10 H11G	11	10	100	14.0	S11	-	K11	-	-
SER 16 16 K16G	16	16	125	21.7	S16	A16	K16	AE16	AI16
SER 20 20 K16G	16	20	125	26.2	S16	A16	K16	AE16	AI16

* Toolholders with no anvil

For **LEFT HAND** toolholders specify **SEL** instead of **SER**

Standard Kits

Threading Kits are a versatile solution for users that cut a variety of thread types in limited quantity and do not want to sacrifice thread quality.

EXTERNAL ISO KIT Ordering Code:KEG

INSERTS

16 ER A60 P25C
16 ER G60 P25C
16 ER 0.75 ISO P25C
16 ER 1.0 ISO P25C
16 ER 1.25 ISO P25C
16 ER 1.5 ISO P25C
16 ER 1.75 ISO P25C
16 ER 2.0 ISO P25C
16 ER 2.5 ISO P25C
16 ER 3.0 ISO P25C

TOOLHOLDER

SER 2020 K16

KEY

K16

SCREW

S16

INTERNAL ISO KIT Ordering Code:KIG

INSERTS

16 IR A60 P25C
16 IR G60 P25C
16 IR 0.75 ISO P25C
16 IR 1.0 ISO P25C
16 IR 1.25 ISO P25C
16 IR 1.5 ISO P25C
16 IR 1.75 ISO P25C
16 IR 2.0 ISO P25C
16 IR 2.5 ISO P25C
16 IR 3.0 ISO P25C

TOOLHOLDER

SIR 0020 P16

KEY

K16

SCREW

S16



If a larger toolholder with a 25 mm shank is required, add to the Kit "25". For example: KIG-25

Type B Kits

Type B threading inserts.
A combination of ground profile and sintered chip-breaker threading inserts.
BMA Grade: Sub-Micron carbide grade with TIALN Multi-Layer Coating.

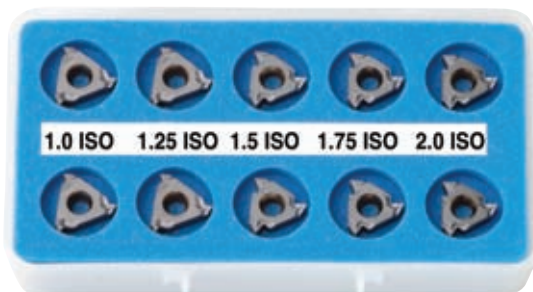

EXTERNAL ISO KIT KEMB-BMA

16 ER B 1.0 ISO BMA 2 Pcs
16 ER B 1.25 ISO BMA 2 Pcs
16 ER B 1.5 ISO BMA 2 Pcs
16 ER B 1.75 ISO BMA 2 Pcs
16 ER B 2.0 ISO BMA 2 Pcs

INTERNAL ISO KIT KIMB-BMA

16 IR B 1.0 ISO BMA 2 Pcs
16 IR B 1.25 ISO BMA 2 Pcs
16 IR B 1.5 ISO BMA 2 Pcs
16 IR B 1.75 ISO BMA 2 Pcs
16 IR B 2.0 ISO BMA 2 Pcs

Miniature & Ultra-miniature Kits



Ordering Code	Type	No. of Inserts	Insert	Contents	
				Boring Bar	Key
KU60M-BXC	ULTRA	10	06 IR A60 BXC	SIR 0005 H06	K6
KM60M-BXC	MINI	10	08 IR A60 BXC	SIR 0007 K08	K8

Threading & Boring Combination Kit

A practical and convenient combination kit for **Ultra Miniature** Threading and Boring. It enables Boring and Threading of mini bores as small as **6 mm diameter (1/4")** with just one deep reaching CARBIDE shank ultra mini Boring Bar.



Ordering Code	Threading Insert	Contents		Key
		Turning Insert	Boring Bar	
KC6TM	06 IR A60 BXC 10 Pcs	06 IR TURN BMA 10 Pcs	SIR 0005 H06CB	K6

- BMA** - Coated carbide grade for medium to high cutting speeds
- BXC** - Coated carbide grade for low cutting speed - 40 to 90 m/min
- CB** - Carbide shank boring bar with coolant bore

Thread Helix Angle

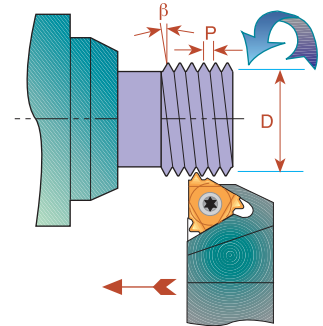
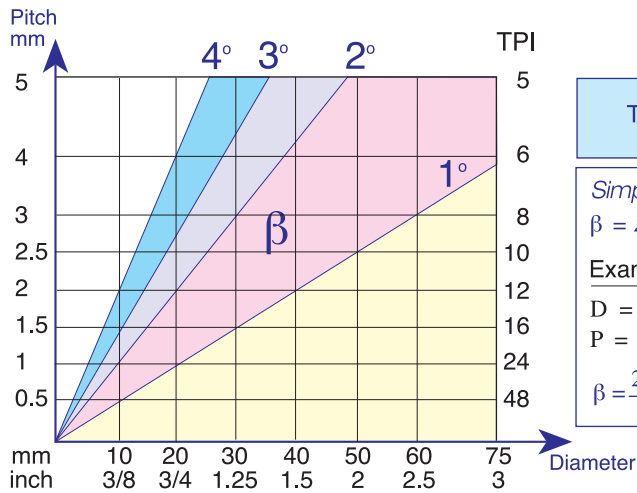

Standard and Slanted Anvils

Carmex Toolholders Pockets have a built in 1.5° helix angle. This angle may be adjusted to better match the thread helix angle by simply changing the anvil.

Negative helix is usually used when threading RH thread with LH Holder or LH thread with RH Holder.

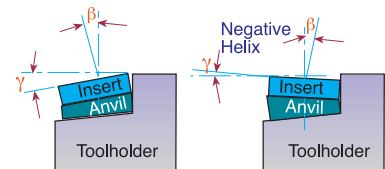

L	IC	Pocket's Angle	4.5°	3.5°	2.5°	1.5° Standard	0.5°	-0.5°	-1.5°
16	3/8	EX-RH OR IN-LH	AE16+4.5	AE16+3.5	AE16+2.5	AE16	AE16+0.5	AE16-0.5	AE16-1.5
16	3/8	EX-LH OR IN-RH	AI 16+4.5	AI 16+3.5	AI 16+2.5	AI 16	AI 16+0.5	AI 16-0.5	AI 16-1.5
22	1/2	EX-RH OR IN-LH	AE22+4.5	AE22+3.5	AE22+2.5	AE22	AE22+0.5	AE22-0.5	AE22-1.5
22	1/2	EX-LH OR IN-RH	AI 22+4.5	AI 22+3.5	AI 22+2.5	AI 22	AI 22+0.5	AI 22-0.5	AI 22-1.5
22U	1/2U	EX-RH OR IN-LH	AE22U+4.5	AE22U+3.5	AE22U+2.5	AE22U	AE22U+0.5	AE22U-0.5	AE22U-1.5
22U	1/2U	EX-LH OR IN-RH	AI 22U+4.5	AI 22U+3.5	AI 22U+2.5	AI 22U	AI 22U+0.5	AI 22U-0.5	AI 22U-1.5
27	5/8	EX-RH OR IN-LH	AE27+4.5	AE27+3.5	AE27+2.5	AE27	AE27+0.5	AE27-0.5	AE27-1.5
27	5/8	EX-LH OR IN-RH	AI 27+4.5	AI 27+3.5	AI 27+2.5	AI 27	AI 27+0.5	AI 27-0.5	AI 27-1.5
27U	5/8U	EX-RH OR IN-LH	AE27U+4.5	AE27U+3.5	AE27U+2.5	AE27U	AE27U+0.5	AE27U-0.5	AE27U-1.5
27U	5/8U	EX-LH OR IN-RH	AI 27U+4.5	AI 27U+3.5	AI 27U+2.5	AI 27U	AI 27U+0.5	AI 27U-0.5	AI 27U-1.5

Anvil Kits

5 AE and 5 AI anvils with various helix angles



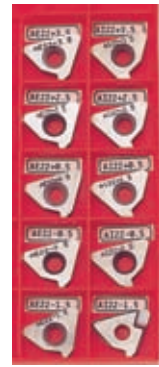

AE (FOR EX.RH. & IN.LH.) AI (FOR IN.RH. & EX.LH.)

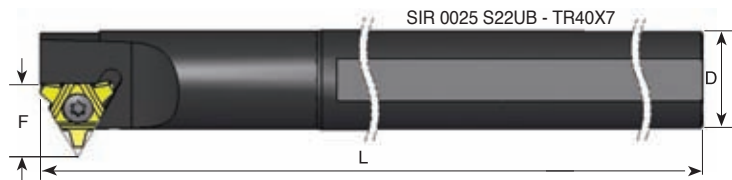
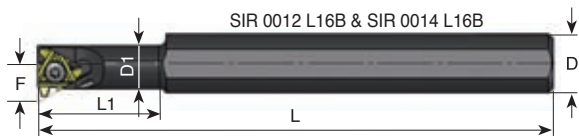
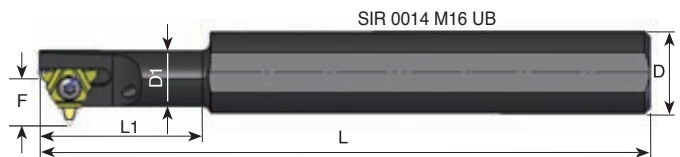
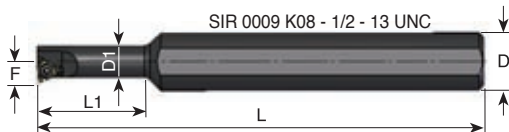

Ordering Code	Contents				
KA16	AE16+4.5 AI 16+4.5	AE16+3.5 AI 16+3.5	AE16+2.5 AI 16+2.5	AE16+0.5 AI 16+0.5	AE16-1.5 AI 16-1.5
KA22	AE22+4.5 AI 22+4.5	AE22+3.5 AI 22+3.5	AE22+2.5 AI 22+2.5	AE22+0.5 AI 22+0.5	AE22-1.5 AI 22-1.5
KA22U	AE22U+4.5 AI 22U+4.5	AE22U+3.5 AI 22U+3.5	AE22U+2.5 AI 22U+2.5	AE22U+0.5 AI 22U+0.5	AE22U-1.5 AI 22U-1.5
KA27	AE27+4.5 AI 27+4.5		AE27+2.5 AI 27+2.5		AE27-1.5 AI 27-1.5
KA27U	AE27U+4.5 AI 27U+4.5		AE27U+2.5 AI 27U+2.5		AE27U-1.5 AI 27U-1.5

Special Thread Turning Applications



Ordering Code Right Hand		D	D1	L	L1	F	Thread	Insert Screw	Torx Key
*SIR 0009 K08	8	16	8.7	125	30	6.5	1/2 -13UNC	S08	K08
SIR 0012 L16B	16	20	11.5	140	33	10.5	TR18x4	S16S	K16
SIR 0014 L16B	16	20	12.5	140	36	21.1	TR20x4	S16S	K16
SIR 0014 M16UB	16	20	13.5	150	40	13.2	TR22x5	S16S	K16
SIR 0025 S22UB	22	25	-	250	-	19.5	TR40x7	S22S	K22

For **LEFT HAND** toolholders specify **SIL** instead of **SIR**

* Only **RIGHT HAND** available

Double Sided Thread Turning Inserts



Carmex presents a unique line of 2 sided inserts including 6 cutting edges, a cost saving tool.



Advantages of DSI-Thread Turning Inserts

- Increased productivity thanks to the six cutting edges.
- U Style inserts for a wide range of full or partial profile standard threads.
- Same insert for right hand or left hand thread.
- Saving on tooling costs.
- Unique anti-vibration anvil design for clamping the insert and supporting the cutting edge.
- Simple insert's mounting and cutting edge changing.
- Heavy duty toolholders designed specifically for this line.

Content:

Page:

Product Identification	50
Partial Profile 60°	51
Partial Profile 55°	51
ISO	52
UN	52
WHITWORTH 55°	53
NPT	53
Thread Turning Toolholder - External	54
Thread Turning Toolholder - Internal	54

Product Identification

DSI Ordering Code

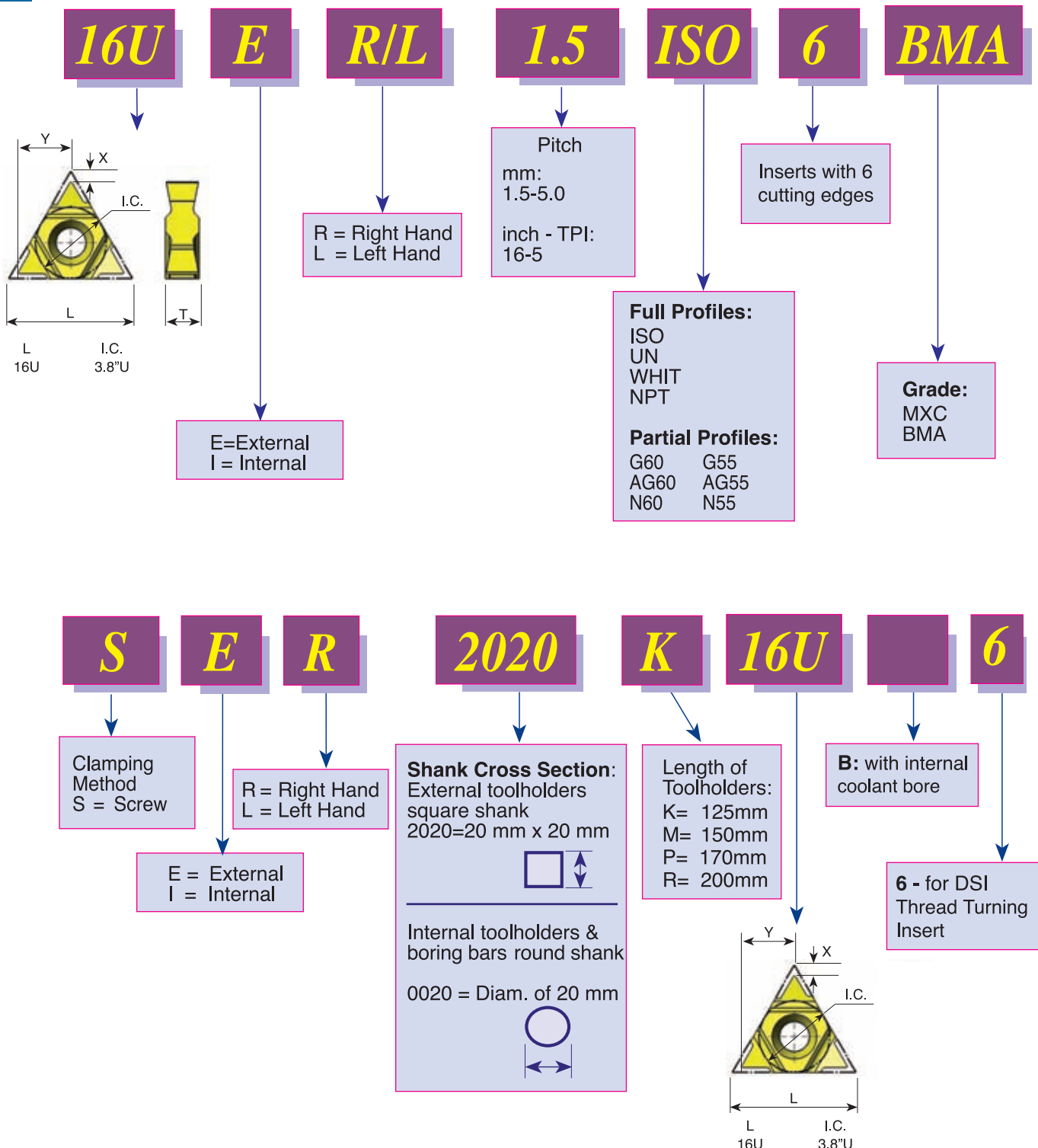

Partial Profile 60°

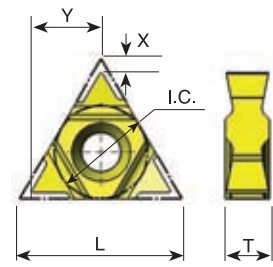

Pitch Range mm	Pitch Range TPI	L	I.C. in	EXTERNAL Ordering Code	INTERNAL Ordering Code	X	Y	T
1.75 - 3.0	14 - 8	16U	3/8U	16U ER/L G60-6	16U IR/L G60-6	1.4	7.1	4.5
0.5 - 3.0	48 - 8	16U	3/8U	16U ER/L AG60-6	16U IR/L AG60-6	1.4	7.1	4.5
3.5 - 5.0	7 - 5	16U	3/8U	16U ER/L N60-6	16U IR/L N60-6	1.2	7.3	4.5

Available coating grades: BMA or MXC

Partial Profile 55°

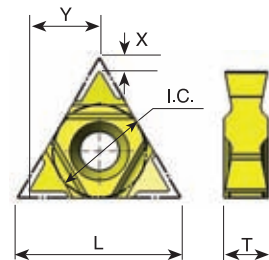

Pitch Range mm	Pitch Range TPI	L	I.C. in	EXTERNAL Ordering Code	INTERNAL Ordering Code	X	Y	T
1.75 - 3.0	14 - 8	16U	3/8U	16U ER/L G55-6	16U IR/L G55-6	1.4	7.1	4.5
0.5 - 3.0	48 - 8	16U	3/8U	16U ER/L AG55-6	16U IR/L AG55-6	1.4	7.1	4.5
3.5 - 5.0	7 - 5	16U	3/8U	16U ER/L N55-6	16U IR/L N55-6	1.2	7.3	4.5

Available coating grades: BMA or MXC

For Carbide Grade and Cutting Speed see page 56

ISO

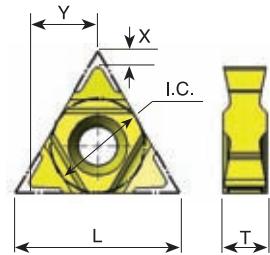

Pitch mm	L	I.C. in	EXTERNAL Ordering Code	INTERNAL Ordering Code	X	Y	T
1.5	16U	3/8U	16U ER/L 1.5 ISO-6	16U IR/L 1.5 ISO-6	1.6	6.9	4.5
1.75	16U	3/8U	16U ER/L 1.75 ISO-6	16U IR/L 1.75 ISO-6	1.6	6.9	4.5
2.0	16U	3/8U	16U ER/L 2.0 ISO-6	16U IR/L 2.0 ISO-6	1.6	6.9	4.5
2.5	16U	3/8U	16U ER/L 2.5 ISO-6	16U IR/L 2.5 ISO-6	1.6	6.9	4.5
3.0	16U	3/8U	16U ER/L 3.0 ISO-6	16U IR/L 3.0 ISO-6	1.6	6.9	4.5
3.5	16U	3/8U	16U ER/L 3.5 ISO-6	16U IR/L 3.5 ISO-6	1.6	6.9	4.5
4.0	16U	3/8U	16U ER/L 4.0 ISO-6	16U IR/L 4.0 ISO-6	1.6	6.9	4.5
4.5	16U	3/8U	16U ER/L 4.5 ISO-6	16U IR/L 4.5 ISO-6	1.6	6.9	4.5
5.0	16U	3/8U	16U ER/L 5.0 ISO-6	16U IR/L 5.0 ISO-6	1.6	6.9	4.5

Available coating grades: BMA or MXC

UN - Unified **UNC, UNF, UNEF, UNS**

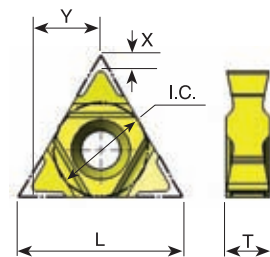

Pitch TPI	L	I.C. in	EXTERNAL Ordering Code	INTERNAL Ordering Code	X	Y	T
16	16U	3/8U	16U ER/L 16 UN-6	16U IR/L 16 UN-6	1.6	6.9	4.5
14	16U	3/8U	16U ER/L 14 UN-6	16U IR/L 14 UN-6	1.6	6.9	4.5
13	16U	3/8U	16U ER/L 13 UN-6	16U IR/L 13 UN-6	1.6	6.9	4.5
12	16U	3/8U	16U ER/L 12 UN-6	16U IR/L 12 UN-6	1.6	6.9	4.5
11.5	16U	3/8U	16U ER/L 11.5 UN-6	16U IR/L 11.5 UN-6	1.6	6.9	4.5
11	16U	3/8U	16U ER/L 11 UN-6	16U IR/L 11 UN-6	1.6	6.9	4.5
10	16U	3/8U	16U ER/L 10 UN-6	16U IR/L 10 UN-6	1.6	6.9	4.5
9	16U	3/8U	16U ER/L 9 UN-6	16U IR/L 9 UN-6	1.6	6.9	4.5
8	16U	3/8U	16U ER/L 8 UN-6	16U IR/L 8 UN-6	1.6	6.9	4.5
7	16U	3/8U	16U ER/L 7 UN-6	16U IR/L 7 UN-6	1.6	6.9	4.5
6	16U	3/8U	16U ER/L 6 UN-6	16U IR/L 6 UN-6	1.6	6.9	4.5
5	16U	3/8U	16U ER/L 5 UN-6	16U IR/L 5 UN-6	1.6	6.9	4.5

Available coating grades: BMA or MXC

For Carbide Grade and Cutting Speed see page 56

Whitworth 55° BSW, BSF, BSP, BSB

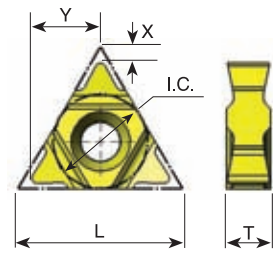

Pitch TPI	L	I.C. in	EXTERNAL Ordering Code	INTERNAL Ordering Code	X	Y	T
16	16U	3/8U	16U ER/L 16 W-6	16U IR/L 16 W-6	1.6	6.9	4.5
14	16U	3/8U	16U ER/L 14 W-6	16U IR/L 14 W-6	1.6	6.9	4.5
12	16U	3/8U	16U ER/L 12 W-6	16U IR/L 12 W-6	1.6	6.9	4.5
11	16U	3/8U	16U ER/L 11 W-6	16U IR/L 11 W-6	1.6	6.9	4.5
10	16U	3/8U	16U ER/L 10 W-6	16U IR/L 10 W-6	1.6	6.9	4.5
9	16U	3/8U	16U ER/L 9 W-6	16U IR/L 9 W-6	1.6	6.9	4.5
8	16U	3/8U	16U ER/L 8 W-6	16U IR/L 8 W-6	1.6	6.9	4.5
7	16U	3/8U	16U ER/L 7 W-6	16U IR/L 7 W-6	1.6	6.9	4.5
6	16U	3/8U	16U ER/L 6 W-6	16U IR/L 6 W-6	1.6	6.9	4.5
5	16U	3/8U	16U ER/L 5 W-6	16U IR/L 5 W-6	1.4	7.2	4.5

Available coating grades: BMA or MXC

NPT

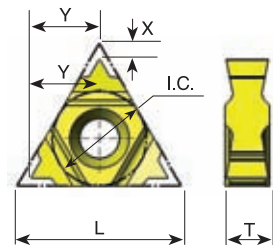

Pitch TPI	L	I.C. in	EXTERNAL Ordering Code	INTERNAL Ordering Code	X	Y	T
14	16U	3/8U	16U ER/L 14 NPT-6	16U IR/L 14 NPT-6	1.6	6.9	4.5
11.5	16U	3/8U	16U ER/L 11.5 NPT-6	16U IR/L 11.5 NPT-6	1.6	6.9	4.5
8	16U	3/8U	16U ER/L 8 NPT-6	16U IR/L 8 NPT-6	1.6	6.9	4.5

Available coating grades: BMA or MXC

For Carbide Grade and Cutting Speed see page 56

Heavy Duty Thread Turning Toolholders

External

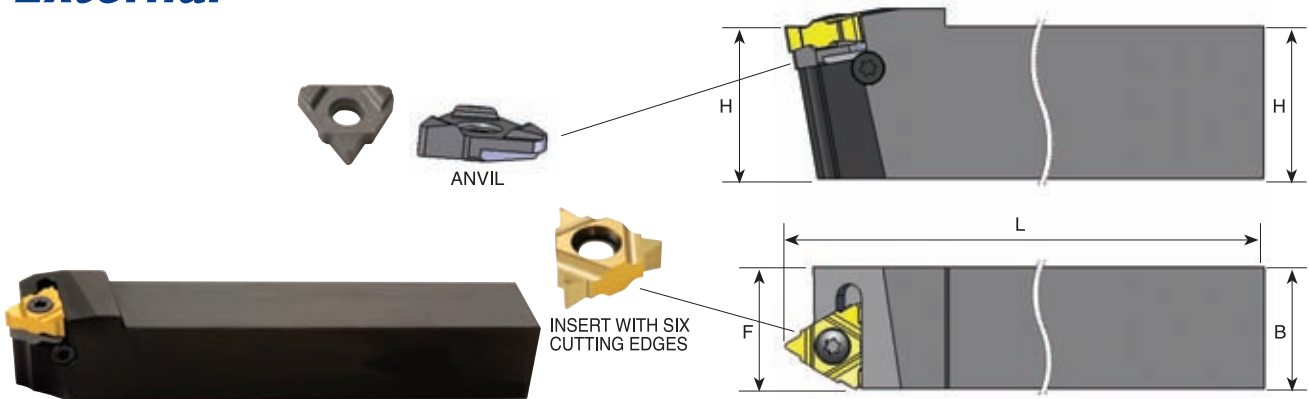

Ordering Code Right Hand	H	B	L	F	Insert Screw	Anvil Screw	Torx Key	RH Anvil	LH Anvil
SER 2020 K16U-6	20	20	125	20	S16	A16	K16	AER 16U-6	AEL 16U-6
SER 2520 M16U-6	25	20	150	20	S16	A16	K16	AER 16U-6	AEL 16U-6

For **LEFT HAND** toolholders specify **SEL** instead of **SER**

Internal with Coolant Bore

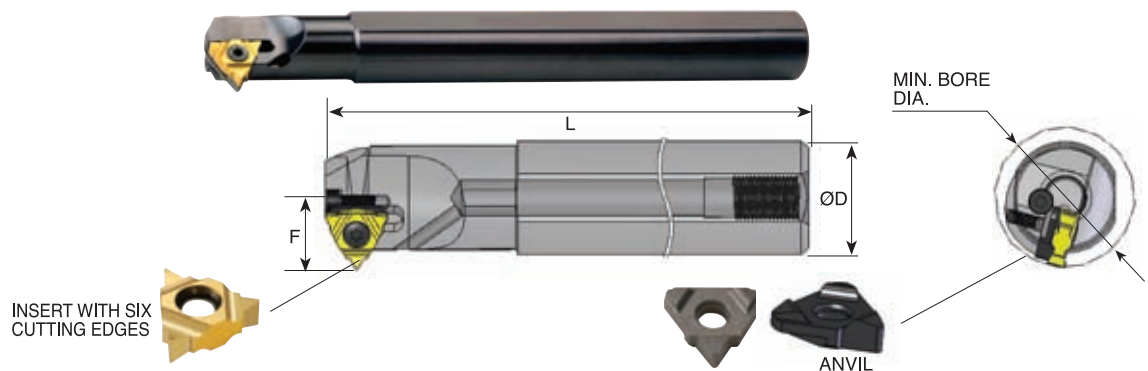

Ordering Code Right Hand	Ø D	Min. bore dia.	L	F	Insert Screw	Anvil Screw	Torx Key	RH Anvil	LH Anvil
SIR 0020 P16UB-6	20	24	170	14.9	S16	A16	K16	AIR 16U-6	AIL 16U-6
SIR 0025 R16UB-6	25	29	200	17.4	S16	A16	K16	AIR 16U-6	AIL 16U-6

For **LEFT HAND** toolholders specify **SIL** instead of **SIR**

Thread Turning Technical Section

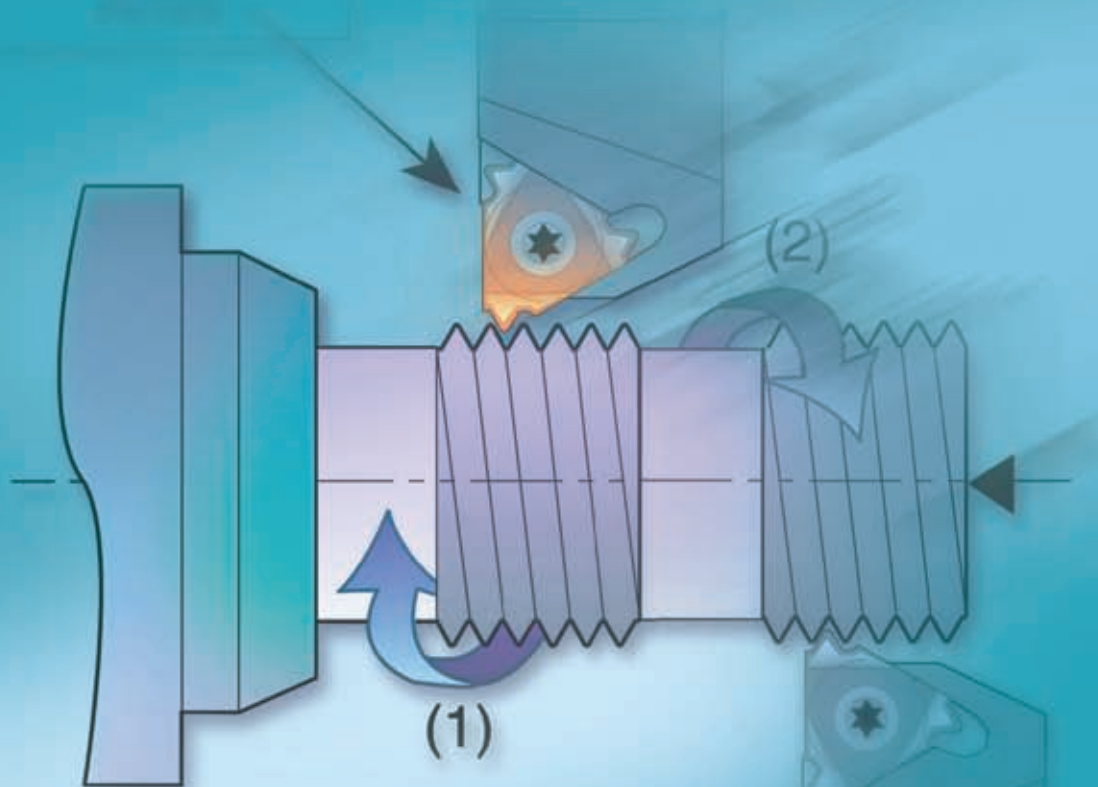

Thread Turning Catalogue and CNC Programming Software

Contents:

Page:

Carbide Grade Selection	56
Recommended Cutting Speed	56
Conversion of Cutting Speed to Rotational Speed	57
Number of Threading Passes Selection	57
Number of threading Passes Selection for Single Point Inserts	58
Thread Turning Methods	58
Important Points about Carmex Threading Inserts	59
Anvil Change Recommendation	60
Thread Turning Step by Step	61-62
Troubleshooting	62

Carbide Grade Selection

Choose the Carmex grade specifically formulated for your application from the following list:

Coated Grades

BLU* (M10-M20) (K05-K20) (N10-N20) (S10-S20)
PVD triple layer coated sub-micron grade for stainless steels, cast iron, titanium, non ferrous metals and most of the high temperature alloys.

BMA (P20-P40) (K20-K30)
PVD TiAlN coated sub-micrograin grade for stainless steels and exotic materials at medium to high cutting speeds.

P25C (P15-P35)
PVD TiN coated grade for treated and hard alloy steels (25 HRc & up) at medium to low cutting speeds.

MXC (K10-K20) (P10-P25)
PVD TiN coated micrograin for free cutting untreated alloy steels (below 30 HRc), for stainless steels and cast iron.

BXC** (P30-P50) (K25-K40)
PVD TiN coated grade for low cutting speed. Works well with wide range of stainless steels.

Uncoated Grades

P30* (P20-P30)
Carbide grade for carbon and cast steels, works well at medium to low cutting speeds.

K20* (K10-K30)
Carbide grade for non ferrous metals, aluminum and cast iron.

Note: Due to our unique and specialized production techniques, Carmex coated inserts provide superior cutting performance and exceptionally long tool life.

Recommended cutting speed (m/min) for thread turning inserts

ISO Standard	Material	Condition	Coated					Uncoated		
			BLU	BMA	P25C	MXC	BXC	K20	P30	
P	Non-Alloy Steel and Cast Steel, Free Cutting Steel	<0.25%C	Annealed	110-210	120-180	100-180	100-180	70-150	50-130	
		≥0.25%C	Annealed							
		< 0.55%C	Quenched & Tempered							
		≥0.55%C	Annealed							
	Low Alloy Steel and Cast Steel (less than 5% alloying elements)	Annealed	90-140	80-130	70-120	70-120	60-90	50-80		
		Quenched & Tempered								
High Alloy Steel, Cast Steel, and Tool Steel	Annealed	70-90	60-80	50-60	55-70	50-60	40-50			
	Quenched & Tempered									
M	Stainless Steel and Cast Steel	Ferritic/Martensitic	110-160	90-130	60-90	60-90	50-80	50-80		
		Martensitic								
		Austenitic								
K	Cast Iron Nodular (GGG)	Ferritic/Pearlitic	120-150	100-130		80-110	60-90			
		Pearlitic								
	Grey Cast Iron (GG)	Ferritic	140-150	120-130		90-100	65-85			
		Pearlitic								
Malleable Cast Iron	Ferritic	110-140	100-130		80-100	60-85				
	Pearlitic									
N	Aluminum-Wrought Alloy	Not Cureable	700-1000			600-800	450-600	600-800	350-500	
		Cured								
	Aluminum-Cast, Alloyed	<= 12% Si	Not Cureable	280-750			200-550	150-350	200-550	110-300
			Cured							
		> 12% Si	High Temperature							
	Copper Alloys	> 1% Pb	Free Cutting	190-350			150-250	110-180	150-250	90-150
			Brass							
		Electrolytic Copper								
Non Metallic		Duroplastics, Fiber Plastics				200-300	150-210	100-200	110-150	
		Hard Rubber								
S	High Temp. Alloys, Super Alloys	Fe based	Annealed	30-65	25-60					
			Cured							
		Ni or Co based	Annealed							
			Cured							
	Titanium Alloys	Cast	40-50	35-45				35-45		
H	Hardened Steel	Hardened 45-50 HRc	40-50	35-45						
		Hardened 51-55 HRc								
		Hardened 56-62 HRc								
	Chilled Cast Iron	Cast	30-40	25-35						
Cast Iron	Hardened	20-30	15-25							

• Available for size 16 mm inserts only

* Upon request

** For miniature and ultra miniature insert

Conversion of Cutting Speed to Rotational Speed

Conversion of a selected cutting speed to rotational speed is calculated by the following formula:

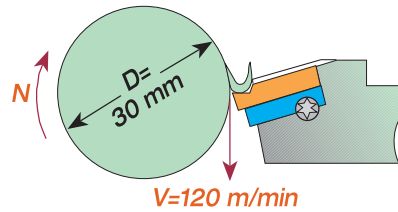

Example

$$N = \frac{V \times 1000}{\pi \times D} = \frac{120 \times 1000}{3.14 \times 30} = 1274 \text{ RPM}$$

Number of passes and depth of cut per pass for multitooth inserts

	Pitch mm	Insert Size		No. of Teeth	Ordering Code	No. of Passes	Depth of Cut per Pass			
		L	I.C. (in)				1	2	3	4
ISO External	1.00	16	3/8	3	16 ER 1.0 ISO 3M	2	0.38	0.25		
	1.50	16	3/8	2	16 ER 1.5 ISO 2M	3	0.42	0.30	0.20	
	1.50	22	1/2	3	22 ER 1.5 ISO 3M	2	0.55	0.37		
	2.00	22	1/2	2	22 ER 2.0 ISO 2M	3	0.57	0.40	0.28	
	2.00	22	1/2	3	22 ER 2.0 ISO 3M	2	0.76	0.49		
	3.00	27	5/8	2	27 ER 3.0 ISO 2M	4	0.59	0.51	0.42	0.32
ISO Internal	1.00	16	3/8	3	16 IR 1.0 ISO 3M	2	0.33	0.25		
	1.50	16	3/8	2	16 IR 1.5 ISO 2M	3	0.38	0.29	0.20	
	1.50	22	1/2	3	22 IR 1.5 ISO 3M	2	0.50	0.37		
	2.00	22	1/2	2	22 IR 2.0 ISO 2M	3	0.52	0.37	0.26	
	2.00	22	1/2	3	22 IR 2.0 ISO 3M	2	0.70	0.45		
	3.00	27	5/8	2	27 IR 3.0 ISO 2M	4	0.58	0.46	0.39	0.30
UN External	16	16	3/8	2	16 ER 16 UN 2M	3	0.44	0.31	0.22	
	16	22	1/2	3	22 ER 16 UN 3M	2	0.58	0.39		
	12	22	1/2	2	22 ER 12 UN 2M	3	0.59	0.42	0.30	
	12	22	1/2	3	22 ER 12 UN 3M	2	0.78	0.52		
	8	27	5/8	2	27 ER 8 UN 2M	4	0.62	0.54	0.45	0.35
UN Internal	16	16	3/8	2	16 IR 16 UN 2M	3	0.42	0.28	0.22	
	16	22	1/2	3	22 IR 16 UN 3M	2	0.55	0.37		
	12	22	1/2	2	22 IR 12 UN 2M	3	0.53	0.38	0.31	
	12	22	1/2	3	22 IR 12 UN 3M	2	0.74	0.48		
	8	27	5/8	2	27 IR 8 UN 2M	4	0.63	0.50	0.40	0.30
Whitworth 55° External	14	16	3/8	2	16 ER 14 W 2M	3	0.52	0.37	0.27	
	14	22	1/2	3	22 ER 14 W 3M	2	0.70	0.46		
	11	22	1/2	2	22 ER 11 W 2M	3	0.67	0.47	0.34	
Whitworth 55° Internal	14	16	3/8	2	16 IR 14 W 2M	3	0.52	0.37	0.27	
	14	22	1/2	3	22 IR 14 W 3M	2	0.70	0.46		
	11	22	1/2	2	22 IR 11 W 2M	3	0.67	0.47	0.34	
NPT External	11.5	16	3/8	2	16 ER 11.5 NPT 2M	4	0.54	0.47	0.37	0.30
	11.5	22	1/2	3	22 ER 11.5 NPT 3M	3	0.76	0.54	0.38	
	8	22	1/2	2	22 ER 8 NPT 2M	4	0.81	0.60	0.55	0.45
NPT Internal	11.5	16	3/8	2	16 IR 11.5 NPT 2M	4	0.54	0.47	0.37	0.30
	11.5	22	1/2	3	22 IR 11.5 NPT 3M	3	0.76	0.54	0.38	
	8	22	1/2	2	22 IR 8 NPT 2M	4	0.81	0.60	0.55	0.45
API Round External	10	22	1/2	2	22 ER 10 APIRD 2M	3	0.60	0.50	0.31	
	10	27	5/8	3	27 ER 10 APIRD 3M	2	1.00	0.41		
	8	27	5/8	2	27 ER 8 APIRD 2M	3	0.80	0.60	0.41	
API Round Internal	10	22	1/2	2	22 IR 10 APIRD 2M	3	0.60	0.50	0.31	
	10	27	5/8	3	27 IR 10 APIRD 3M	2	1.00	0.41		
	8	27	5/8	2	27 IR 8 APIRD 2M	3	0.80	0.60	0.41	

Number of threading passes selection for single point inserts

Pitch:	mm	0.5	0.8	1.0	1.25	1.5	1.75	2.0	2.5	3.0	4.0	6.0
	TPI	48	32	24	20	16	14	12	10	8	6	4
Number of Passes		3-6	4-7	4-9	6-10	5-11	9-12	6-13	7-15	8-17	10-20	11-22

- NOTES:**
1. For most standard applications the middle of the range is a good starting point.
 2. For most materials, the tougher the material, the higher the number of cutting passes you should select.
 3. As a general rule of thumb, less passes are better than more speed.

Thread Turning Methods

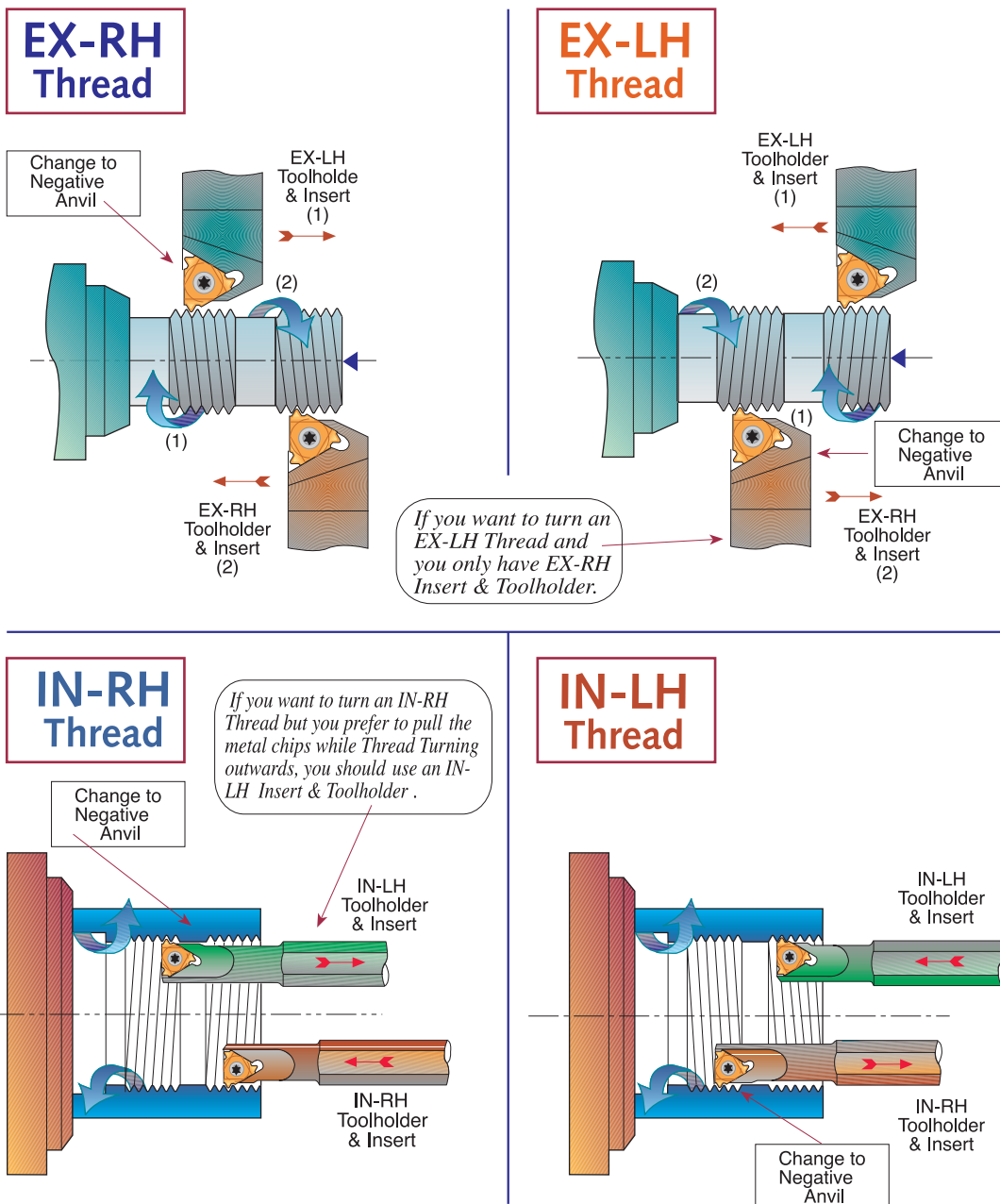

Important Points about Carmex Threading Inserts

1. In most thread forms internal and external threads have different depth and radii, thus tools are not interchangeable

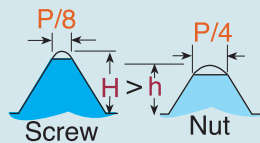

2. The Insert relief angle of a standard Carmex external toolholder is 10°; for an internal toolholder it is 15°. This 5° difference is to provide additional necessary radial clearance.

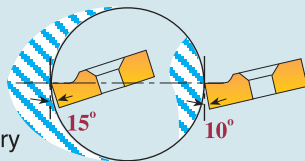

3. Our built-in relief angles ensure automatic insert flank angle clearance

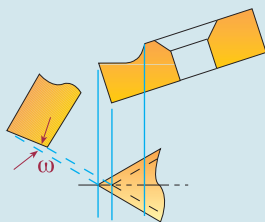

4. Profiles of Carmex internal & external threading inserts are precision ground to ensure accurate thread geometry when used in their corresponding toolholders. Using internal inserts with an external holder will result in distortion of angle and insert geometry.

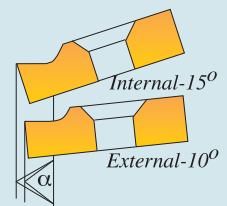

5. Insert and toolholder should always match. An IN-RH insert must be used with an IN-RH toolholder. No mismatch is allowed.



Anvil Change Recommendation

As can be seen from the chart, some Pitch to Diameter combinations require an anvil change. If change is required, use AE anvils for EX-RH and IN-LH toolholders and AI anvils for IN-RH and EX-LH toolholders.

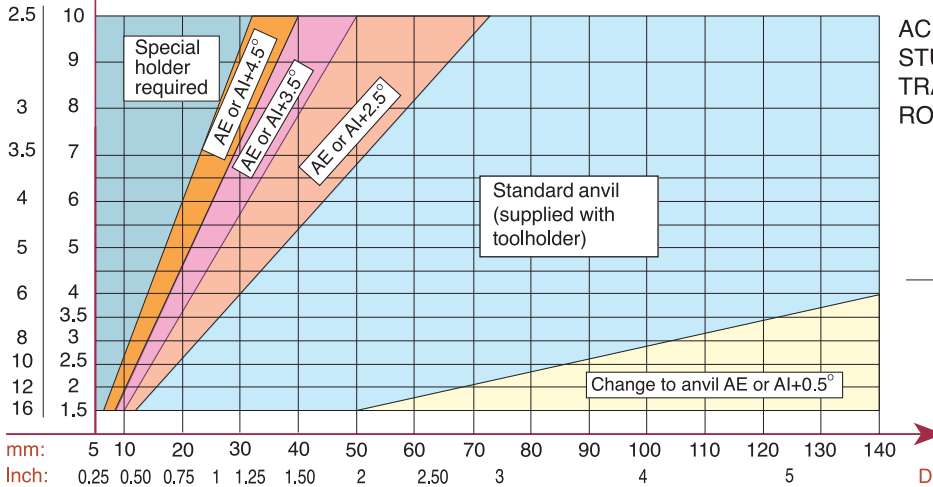

ACME
STUB ACME
TRAPEZ (DIN 103)
ROUND (DIN 405)

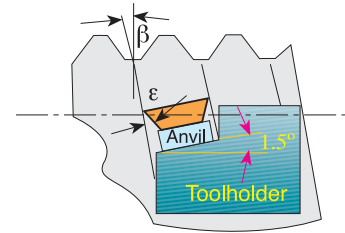

As can be seen from the chart, most applications do not require an anvil change. If change is required, use AE anvils for EX-RH and IN-LH toolholders and AI anvils for IN-RH and EX-LH toolholders

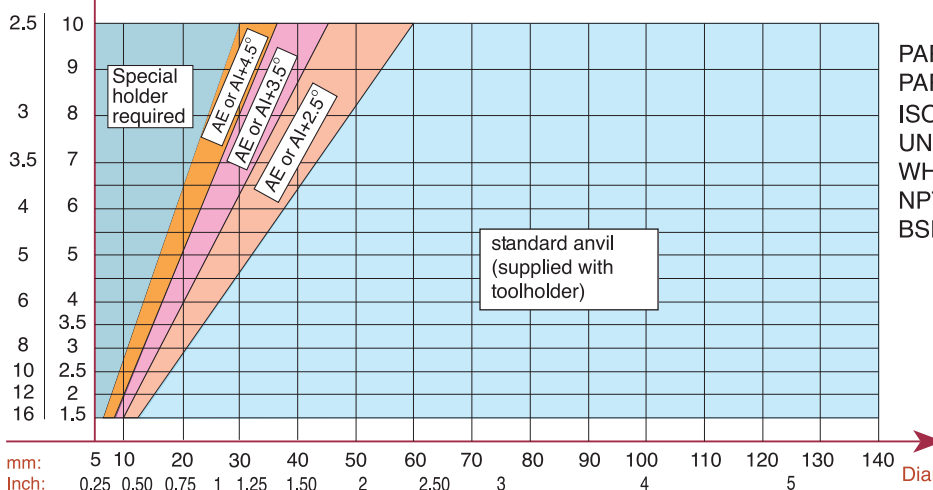

PARTIAL PROFILES 60°
PARTIAL PROFILES 55°
ISO
UN
WHIT.
NPT
BSPT

As can be seen from the chart, most applications require an anvil change. In most cases a negative anvil is required. use AE anvils for EX-RH

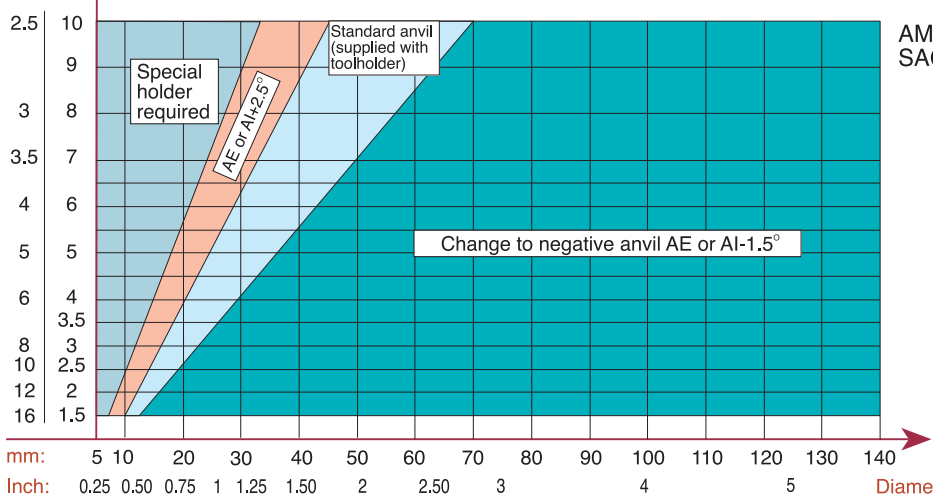

AMERICAN BUTTRESS
SAGENGWINDE (DIN 513)

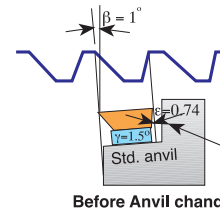

Before Anvil change

Replacing the standard anvil with an anvil with negative angle, will eliminate side rubbing

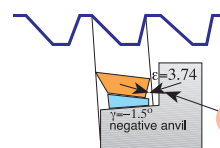

After Anvil Change

Thread Turning - Step by Step

- Step 1 : Choose Thread Turning Method
- Step 2 : Choose Insert
- Step 3 : Choose Toolholder
- Step 4 : Choose Insert Grade
- Step 5 : Choose Thread Turning Speed
- Step 6 : Choose Number of Threading Passes

In most cases the above mentioned 6 steps would be the steps needed to ensure a good thread. When cutting more complicated threads such as TRAPEZ, ACME, BUTTRESS or SAGE, it is advisable to check the effect of the thread "HELIX ANGLE" β on the "RESULTANT FLANK CLEARANCE" ϵ . If ϵ is smaller than 2° , an anvil change is required.

- Step 7 : Find Thread Helix Angle
- Step 8 : Choose Correct Anvil

EXAMPLES:

Example No. 1:

Step 1: Choose Thread Turning Method
from page 46, we chose **EX - RH Insert & Toolholder**

Step 2: Choose Insert from page 9: **16 ER 1.5 ISO**

Step 3: Choose Toolholder from page 39 **SER 2020 K16**

Step 4: Choose Insert Grade from selection on page 56
Our choice for Alloy Steel is Grade **P25C**

Step 5: Choose Thread Turning Speed from chart on page 56,
we chose **100 m/min**

Rotational Speed calculation:
$$N = \frac{100 \times 1000}{\pi \times 30} = 1065 \text{ rpm}$$

Step 6: Choose Number of Threading passes
from table on page 57, we chose **8 passes**

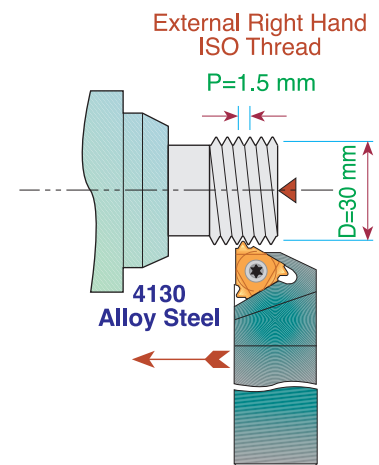

Example No. 2:

Step 1: Choose Thread Turning Method from page 57
Usually, an IN-RH Toolholder and Insert will be chosen, however, in this particular case we prefer to pull the metal chips while thread turning outward, thus we chose to work with **IN-LH Insert & Toolholder**

Step 2: Choose Insert from page 13: **16 IL 12 UN**

Step 3: Choose Toolholder from page 41 : **SIL 0025 R16**
Note: since we thread cut IN-RH thread outward with an IN-LH tool, do not forget to replace the standard anvil (supplied with the holder) with a negative anvil **AE16-1.5**

Step 4: Choose Insert Grade from selection on page 56
Our choice for Brass is Grade **K20**

Step 5: Choose Thread Turning Speed from chart on page 56,
we chose **150 m/min**

Rotational Speed calculation:
$$N = \frac{150 \times 1000}{\pi \times 38.1} = 1254 \text{ RPM}$$

Step 6: Choose Number of Threading passes from table
on page 57, we chose **9 passes**

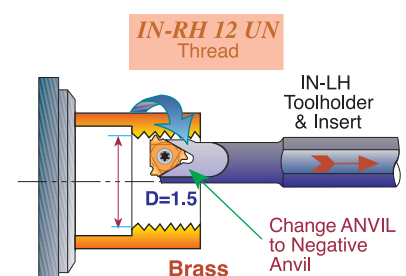

Example No. 3:

Step 1: Choose Thread Turning Method from page 58
We chose **EX-RH** Insert & Toolholder.

Step 2: Choose Insert from page 31: **16 ER 12 ABUT**

Step 3: Choose Toolholder from page 39: **SER 2525 M16**

Step 4: Choose Insert Grade from selection on page 56
Our choice for Stainless Steel is Grade **MXC**

Step 5: Choose Thread Turning Speed from chart on page 57
We chose **120 m/min.**

Rotational Speed calculation:
$$N = \frac{120 \times 1000}{\pi \times 40} = 954 \text{ rpm}$$

Step 6: Choose Number of Threading passes from table on page 57. We chose **13 passes**

Step 7: Find Thread Helix Angle: on page 53 for Pitch of 12 TPI and 40 Diameter Helix Angle as shown in the chart is 1°

Step 8: Choose correct Anvil: As can be seen from the chart on page 60, for AMERICAN BUTTRESS Thread, for 12 TPI and 40 Diameter a negative anvil **AE16-1.5** should replace the standard anvil supplied with the toolholder

EX-RH. AMERICAN BUTTRESS
12 TPI on 40 mm diameter.

Stainless Steel 304

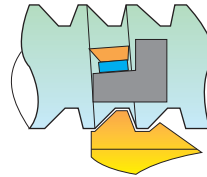

Replacing the standard anvil with an anvil with negative angle, will eliminate side rubbing

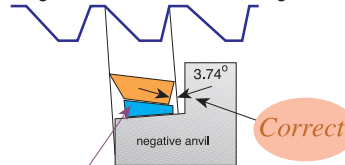

Anvil chosen:
AE16-1.5

Troubleshooting

Chipping

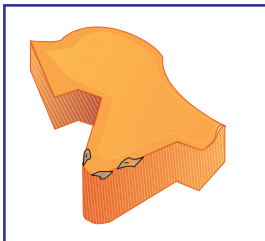

1. Use a tougher carbide grade
2. Eliminate tool overhang
3. Check if insert is correctly clamped
4. Eliminate vibration

Crater Wear

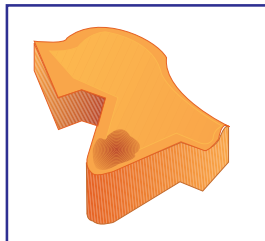

1. Reduce cutting speed
2. Apply coolant fluid
3. Use a harder carbide grade

Build-up Edge



1. Increase cutting speed
2. Use a tougher carbide grade

Thermal Cracking

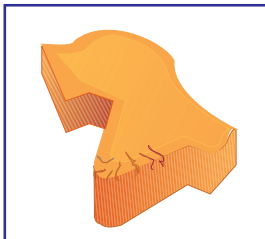

1. Reduce cutting speed
2. Apply coolant fluid
3. Use a tougher carbide grade

Deformation

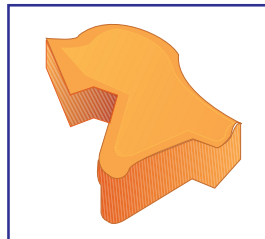

1. Use a harder carbide grade
2. Reduce cutting speed
3. Reduce depth of cut
4. Apply coolant fluid

Fracture

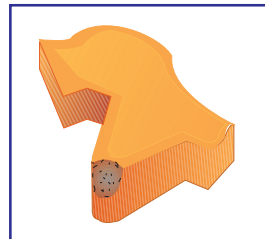

1. Use a tougher carbide grade
2. Reduce depth of cut
3. Index insert sooner
4. Check machine and tool stability

Grooving Tools



A combination of ground profile and sintered chip-breaker

Advantages:

- Same Toolholder for Grooving and Threading
- Minimum Investment in Tooling
 - Three cutting edges
 - Precision Ground

Contents:

Page:

Grooving Inserts
Grooving Inserts for Snap Ring
Grooving Sets
Technical Section

64
64
65
66

Grooving Inserts

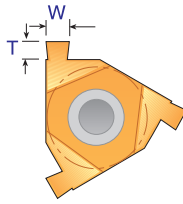

ER / IL

Same insert can be used for EX.RH and for IN.LH.

External & Internal

IR / EL

Same insert can be used for IN.RH. and for EX.LH.

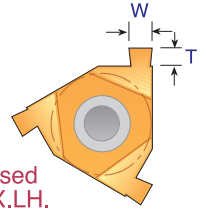

W ± 0.02	T	I.C. in	Ordering Code		Ordering Code	
			ER/IL Inserts	Anvil	IR/EL Inserts	Anvil
0.50	1.4	1/4	11 ER/IL 0.50	-	11 IR/EL 0.50	-
0.60	1.4	1/4	11 ER/IL 0.60	-	11 IR/EL 0.60	-
0.70	1.4	1/4	11 ER/IL 0.70	-	11 IR/EL 0.70	-
0.80	1.4	1/4	11 ER/IL 0.80	-	11 IR/EL 0.80	-
1.00	1.3	1/4	11 ER/IL 1.00	-	11 IR/EL 1.00	-
0.50	1.4	3/8	16 ER/IL 0.50	AE 16-0	16 IR/EL 0.50	AI 16-0
1.00	1.4	3/8	16 ER/IL 1.00	AE 16-0	16 IR/EL 1.00	AI 16-0
1.20	1.6	3/8	16 ER/IL 1.20	AE 16-0	16 IR/EL 1.20	AI 16-0
1.40	1.8	3/8	16 ER/IL 1.40	AE 16-0	16 IR/EL 1.40	AI 16-0
1.70	2.0	3/8	16 ER/IL 1.70	AE 16-0	16 IR/EL 1.70	AI 16-0
1.95	2.0	3/8	16 ER/IL 1.95	AE 16-0	16 IR/EL 1.95	AI 16-0
2.25	2.25	3/8	16 ER/IL 2.25	AE 16-0	16 IR/EL 2.25	AI 16-0

Order example: 16 ER/IL 1.20 BXC

* The inserts should be used with our standard threading toolholders

* Attention: The anvil must be changed to AE 16-0 or AI 16-0

* Other available blank sizes: I.C. 5/8", 1/2", 3/16" & 5/32"

Grooving Inserts for Snap Ring

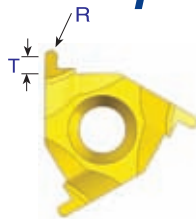

ER / IL

Same insert can be used for EX.RH and for IN.LH.

**External & Internal
Partial Profile Inserts**

IR / EL

Same insert can be used for IN.RH and for EX.LH.

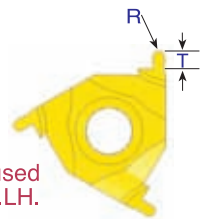

R ±0.04	T	I.C. in	Ordering Code		Ordering Code	
			ER/IL Inserts	Anvil	IR/EL Inserts	Anvil
0.5	1.4	3/8	16 ER/IL R 0.50	AE 16 - 0	16 IR/EL R 0.50	AI 16 - 0
0.6	1.6	3/8	16 ER/IL R 0.60	AE 16 - 0	16 IR/EL R 0.60	AI 16 - 0
0.9	2.0	3/8	16 ER/IL R 0.90	AE 16 - 0	16 IR/EL R 0.90	AI 16 - 0
1.0	2.0	3/8	16 ER/IL R 1.00	AE 16 - 0	16 IR/EL R 1.00	AI 16 - 0
1.1	2.15	3/8	16 ER/IL R 1.10	AE 16 - 0	16 IR/EL R 1.10	AI 16 - 0
1.2	2.25	3/8	16 ER/IL R 1.20	AE 16 - 0	16 IR/EL R 1.20	AI 16 - 0

Order example: 16ER/IL R1.20 BXC

* The inserts should be used with our standard threading toolholders

* Attention: The anvil must be changed to AE 16-0 or AI 16-0

* Other available blank sizes: I.C. 5/8", 1/2", 1/4", 3/16" & 5/32"

Grooving Kits



ER / IL INSERT KGRO - EXTERNAL

16	ER / IL 1.0	BXC	1 unit
16	ER / IL 1.2	BXC	1 unit
16	ER / IL 1.4	BXC	1 unit
16	ER / IL 1.7	BXC	1 unit
16	ER / IL 1.95	BXC	1 unit
16	ER / IL 2.25	BXC	1 unit

ANVIL AE 16 - 0 1 unit

IR / EL INSERT KGRO - INTERNAL

16	IR / EL 1.0	BXC	1 unit
16	IR / EL 1.2	BXC	1 unit
16	IR / EL 1.4	BXC	1 unit
16	IR / EL 1.7	BXC	1 unit
16	IR / EL 1.95	BXC	1 unit
16	IR / EL 2.25	BXC	1 unit

ANVIL AI 16 - 0 1 unit

Technical Section

Cutting Speeds for Grooving Tools

Carbide Grade:

BXC (P30 - P50, K25 - K40)

PVD TiN coated grade for low cutting speed. Works well with a wide range of stainless steels.

BMA (P20 - P40, K20 - K30)

PVD TiAlN coated sub-micrograin grade for stainless steels and exotic materials at medium to high cutting speeds.

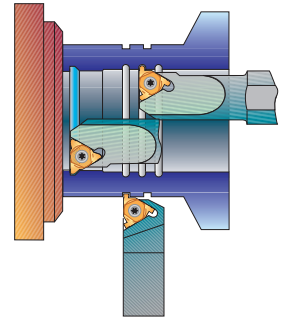

ISO Standard	Materials	Cutting Speed m/min
P	Low & Medium Carbon Steel	20-100
	High Carbon Steel	30-80
	Alloy Steels and Treated Steels	40-90
M	Stainless Steels	30-80
	Cast Steels	30-90
K	Cast Iron	30-90
N	Non-Ferrous & Aluminium	20-200

For grooving small bores see pages 183-188

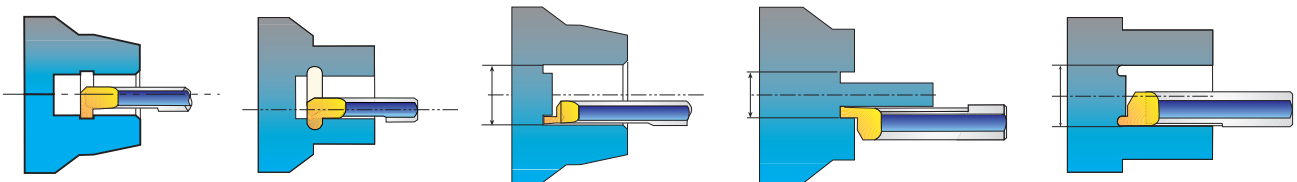

Mill-Thread Inserts and Kits

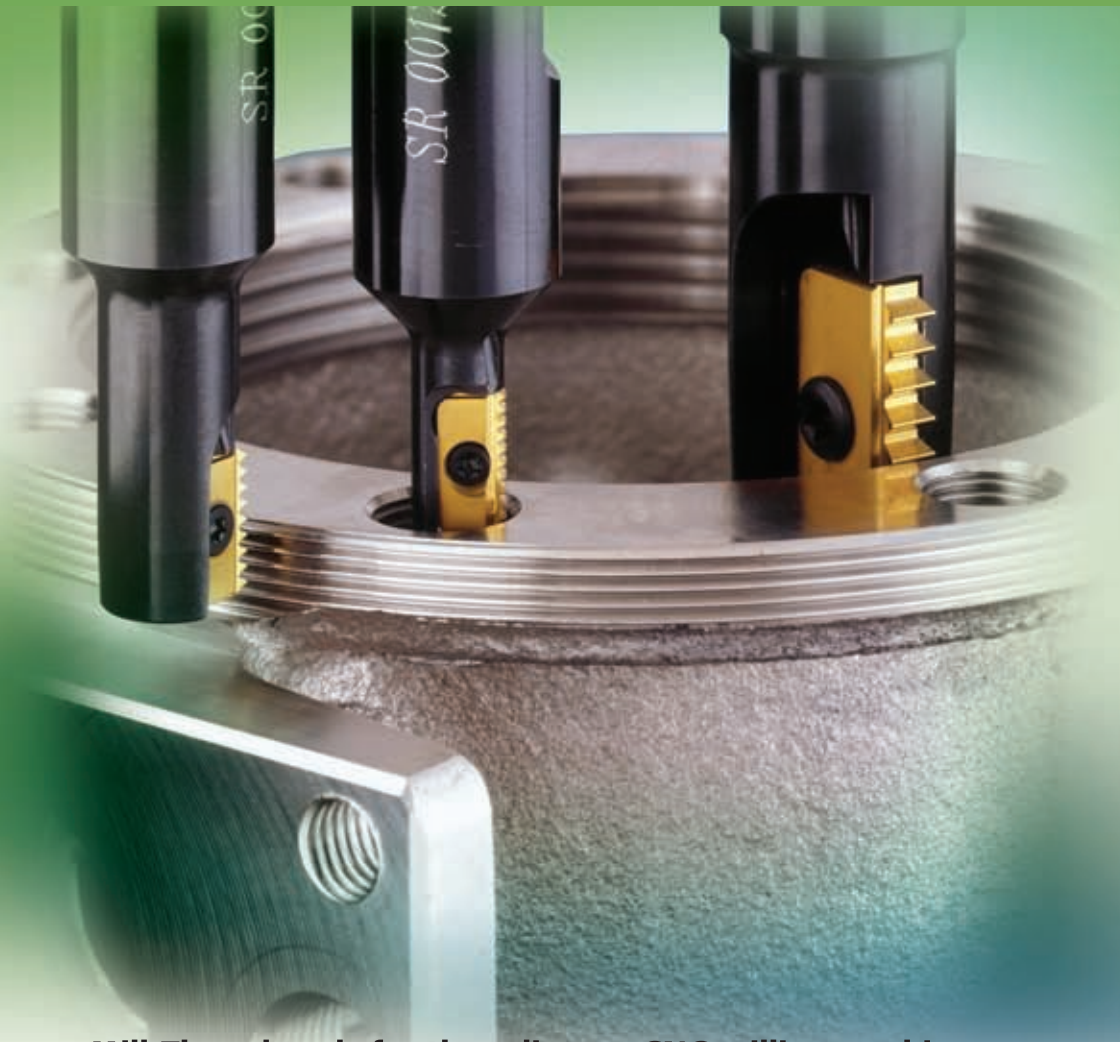

Mill-Thread tools for threading on CNC milling machines by using helical interpolation programs

Advantages of Mill-Thread Tools

- Same toolholder and insert can produce both right-hand and left-hand threads.
- A single insert & toolholder can produce a given thread on many diameters (External & Internal).
- Prismatic shape of insert's tail ensures exact and reliable clamping in the toolholder.
- Most inserts are double sided, having two cutting edges.
- Thread is produced in one tool pass.
- MT tools can produce tapered threads.
- Improved productivity thanks to increased cutting speeds and multitooth type carbide inserts.
- Threading to one pitch of a shoulder in a blind hole.
- Longer tool life thanks to a special multilayer coating process.
- Lower tooling costs, considerably less expensive than using taps and dies.
- Since lower machine power is required, a smaller machine can produce larger threads in a single operation with less idle time and tool changes.

Contents:

Page:

Product Identification	68
ISO	69
UN	70
WHIT	71
BSPT	71
NPT	72
NPTF	72
NPS	73
NPSF	73

Contents:

Page:

PG - DIN 40430	74
Internal ISO Kits	74
Special Tools	75

Product Identification

Mill-Thread Inserts Ordering Codes

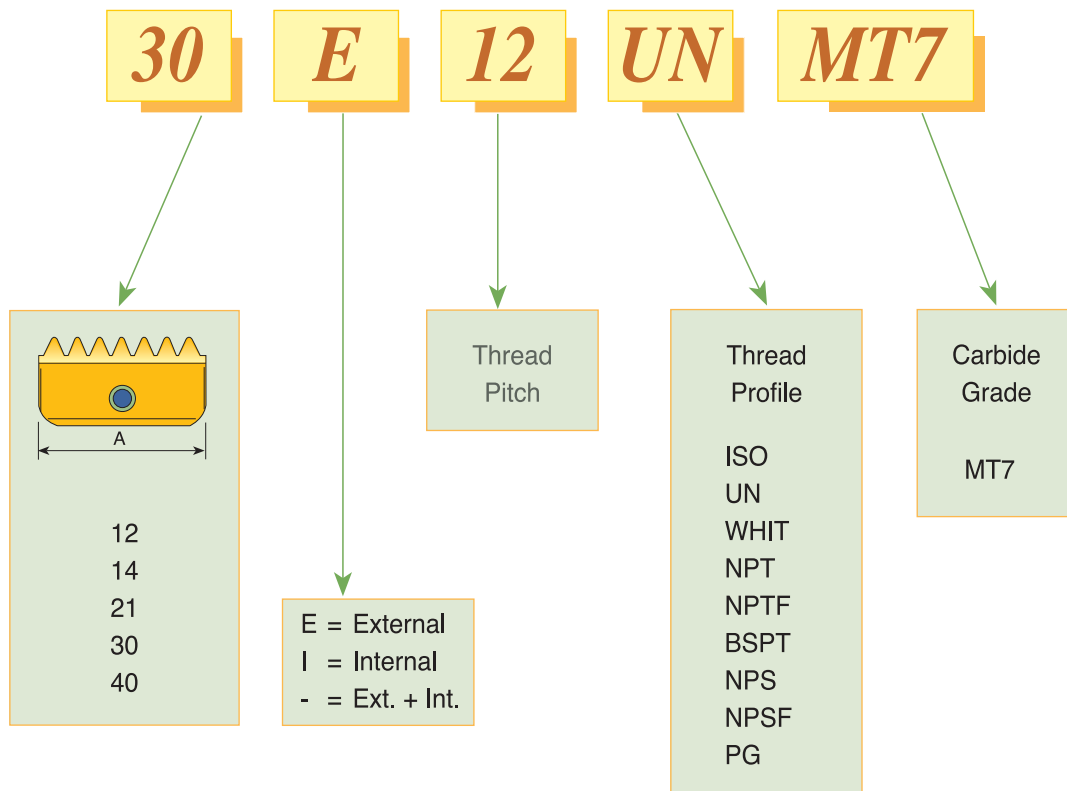

ISO

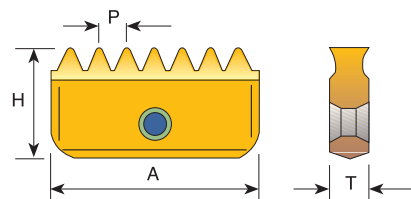
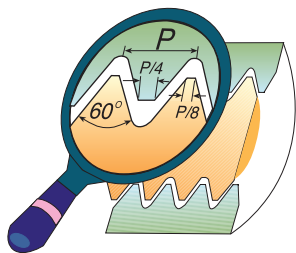

Pitch mm		Insert Size = A				
		12	14	21	30	40
0.5	Ext.					
0.5	Int.	* 12 I 0.5 ISO	14 I 0.5 ISO			
0.75	Ext.		14 E 0.75 ISO			
0.75	Int.	* 12 I 0.75 ISO	14 I 0.75 ISO			
1.0	Ext.		14 E 1.0 ISO	21 E 1.0 ISO		
1.0	Int.	* 12 I 1.0 ISO	14 I 1.0 ISO	21 I 1.0 ISO		
1.25	Ext.		14 E 1.25 ISO			
1.25	Int.	* 12 I 1.25 ISO	14 I 1.25 ISO			
1.5	Ext.		14 E 1.5 ISO	21 E 1.5 ISO	30 E 1.5 ISO	40 E 1.5 ISO
1.5	Int.	* 12 I 1.5 ISO	14 I 1.5 ISO	21 I 1.5 ISO	30 I 1.5 ISO	40 I 1.5 ISO
1.75	Ext.		14 E 1.75 ISO			
1.75	Int.		14 I 1.75 ISO	21 I 1.75 ISO		
2.0	Ext.		14 E 2.0 ISO	21 E 2.0 ISO	30 E 2.0 ISO	40 E 2.0 ISO
2.0	Int.		14 I 2.0 ISO	21 I 2.0 ISO	30 I 2.0 ISO	40 I 2.0 ISO
2.5	Ext.		14 E 2.5 ISO	21 E 2.5 ISO		
2.5	Int.		14 I 2.5 ISO	21 I 2.5 ISO		
3.0	Ext.			21 E 3.0 ISO	30 E 3.0 ISO	40 E 3.0 ISO
3.0	Int.			21 I 3.0 ISO	30 I 3.0 ISO	40 I 3.0 ISO
3.5	Ext.				30 E 3.5 ISO	
3.5	Int.			21 I 3.5 ISO	30 I 3.5 ISO	40 I 3.5 ISO
4.0	Ext.				30 E 4.0 ISO	40 E 4.0 ISO
4.0	Int.				30 I 4.0 ISO	40 I 4.0 ISO
4.5	Ext.					
4.5	Int.				30 I 4.5 ISO	40 I 4.5 ISO
5.0	Ext.					40 E 5.0 ISO
5.0	Int.				30 I 5.0 ISO	40 I 5.0 ISO
5.5	Ext.					
5.5	Int.					40 I 5.5 ISO
6.0	Ext.					40 E 6.0 ISO
6.0	Int.					40 I 6.0 ISO
	H	6.3	7.5	12	16	20
	T	2.9	3.1	4.7	5.5	6.3

* One cutting edge

Order example: 14 I 1.5 ISO MT7

UN UNC, UNF, UNEF, UNS

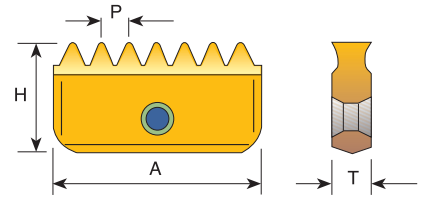
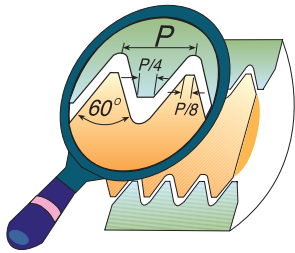

Pitch TPI		Insert Size = A				
		12	14	21	30	40
32	Ext.		14 E 32 UN			
32	Int.	*12 I 32 UN	14 I 32 UN			
28	Ext.		14 E 28 UN			
28	Int.	*12 I 28 UN	14 I 28 UN			
27	Ext.					
27	Int.		14 I 27 UN			
24	Ext.		14 E 24 UN	21 E 24 UN		
24	Int.	*12 I 24 UN	14 I 24 UN	21 I 24 UN		
20	Ext.		14 E 20 UN	21 E 20 UN	30 E 20 UN	
20	Int.	*12 I 20 UN	14 I 20 UN	21 I 20 UN	30 I 20 UN	
18	Ext.		14 E 18 UN	21 E 18 UN	30 E 18 UN	
18	Int.	*12 I 18 UN	14 I 18 UN	21 I 18 UN	30 I 18 UN	
16	Ext.		14 E 16 UN	21 E 16 UN	30 E 16 UN	40 E 16 UN
16	Int.	*12 I 16 UN	14 I 16 UN	21 I 16 UN	30 I 16 UN	40 I 16 UN
14	Ext.		14 E 14 UN	21 E 14 UN	30 E 14 UN	40 E 14 UN
14	Int.		14 I 14 UN	21 I 14 UN	30 I 14 UN	40 I 14 UN
12	Ext.		14 E 12 UN	21 E 12 UN	30 E 12 UN	40 E 12 UN
12	Int.		14 I 12 UN	21 I 12 UN	30 I 12 UN	40 I 12 UN
11	Ext.					
11	Int.		14 I 11 UN			
10	Ext.			21 E 10 UN	30 E 10 UN	40 E 10 UN
10	Int.		14 I 10 UN	21 I 10 UN	30 I 10 UN	40 I 10 UN
8	Ext.				30 E 8 UN	40 E 8 UN
8	Int.			21 I 8 UN	30 I 8 UN	40 I 8 UN
7	Ext.					
7	Int.			21 I 7 UN		
6	Ext.				30 E 6 UN	40 E 6 UN
6	Int.				30 I 6 UN	40 I 6 UN
5	Ext.					
5	Int.				30 I 5 UN	
4.5	Ext.					
4.5	Int.					40 I 4.5UN
4	Ext.					
4	Int.					40 I 4 UN
H		6.3	7.5	12	16	20
T		2.9	3.1	4.7	5.5	6.3

* One cutting edge

Order example: 21 E 18 UN MT7

WHIT BSW, BSF, BSP

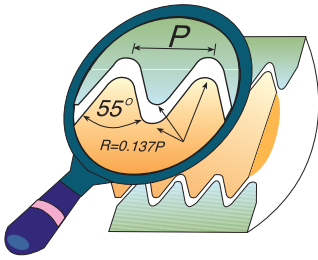

Same Insert for External and Internal thread.

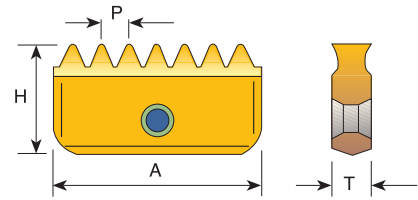

Pitch TPI	Insert Size = A				
	12	14	21	30	40
24		14-24 W			
20		14-20 W	21-20 W		
19	* 12-19 W	14-19 W	21-19 W		
16		14-16 W	21-16 W	30-16 W	
14		14-14 W	21-14 W	30-14 W	
11		14-11 W	21-11 W	30-11 W	40-11 W
8					40- 8 W
H	6.3	7.5	12	16	20
T	2.9	3.1	4.7	5.5	6.3

* One cutting edge

Order example: 21-11 W MT7

BSPT

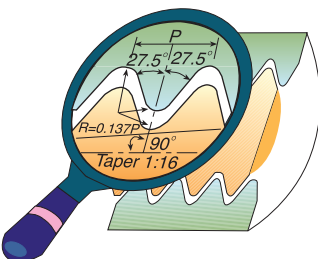

Conical pipe thread inserts are one-sided and may be used for both External and Internal threading.

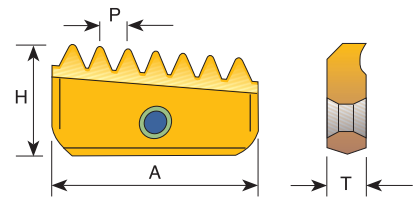

Pitch TPI	Insert Size = A				
	12	14	21	30	40
19	12-19 BSPT	14-19 BSPT			
14		14-14 BSPT	21-14 BSPT		
11			21-11 BSPT	30-11 BSPT	40-11 BSPT
H	6.3	7.5	12	16	20
T	2.9	3.1	4.7	5.5	6.3

Order example: 14-19 BSPT MT7

For conical preparation end mills see page 121

NPT

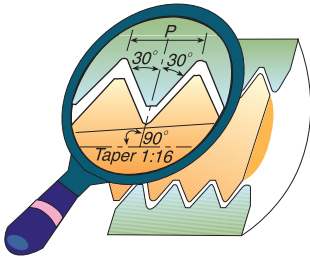

Conical pipe thread inserts are one-sided and may be used for both External and Internal threading.

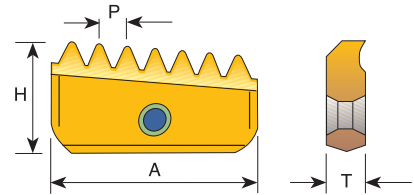

Pitch TPI	12	14	Insert Size = A		
			21	30	40
18	12-18 NPT	14-18 NPT			
14		14-14 NPT	21-14 NPT		
11.5			21-11.5 NPT	30-11.5 NPT	40-11.5 NPT
8				30- 8 NPT	40- 8 NPT
H	6.3	7.5	12	16	20
T	2.9	3.1	4.7	5.5	6.3

Order example: 30-11.5 NPT MT7

NPTF

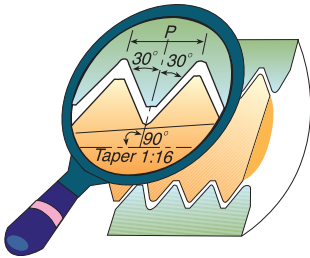

Conical pipe thread inserts are one-sided and may be used for both External and Internal threading.

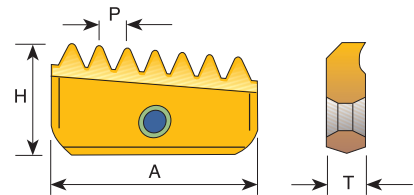

Pitch TPI	12	14	Insert Size = A		
			21	30	40
18	12-18 NPTF	14-18 NPTF			
14		14-14 NPTF	21-14 NPTF		
11.5			21-11.5 NPTF	30-11.5 NPTF	40-11.5 NPTF
8				30- 8 NPTF	40- 8 NPTF
H	6.3	7.5	12	16	20
T	2.9	3.1	4.7	5.5	6.3

Order example: 21-14 NPTF MT7

For conical preparation end mills see page 121

NPS

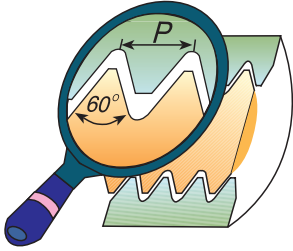

Same Insert for External and Internal thread

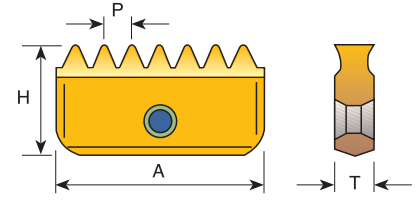

Pitch TPI	12	14	Insert Size = A 21	30	40
18	12-18 NPS	14-18 NPS			
14		14-14 NPS	21-14 NPS		
11.5			21-11.5 NPS	30-11.5 NPS	40-11.5 NPS
8				30- 8 NPS	40- 8 NPS
H	6.3	7.5	12	16	20
T	2.9	3.1	4.7	5.5	6.3

Order example: 30-11.5 NPS MT7

NPSF

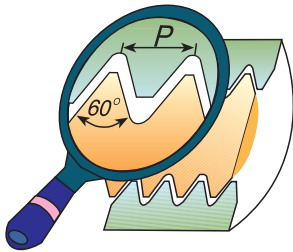

Same Insert for External and Internal thread

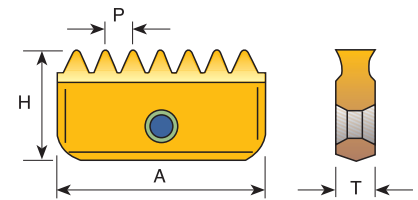

Pitch TPI	12	14	Insert Size = A 21	30	40
18	12-18 NPSF	14-18 NPSF			
14		14-14 NPSF	21-14 NPSF		
11.5			21-11.5 NPSF	30-11.5 NPSF	40-11.5 NPSF
8				30- 8 NPSF	40- 8 NPSF
H	6.3	7.5	12	16	20
T	2.9	3.1	4.7	5.5	6.3

Order example: 21-14 NPSF MT7

PG - DIN 40430

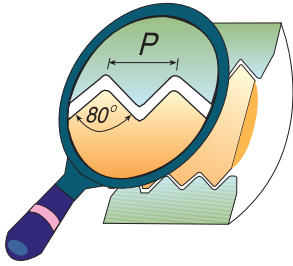

Same Insert for External and Internal thread

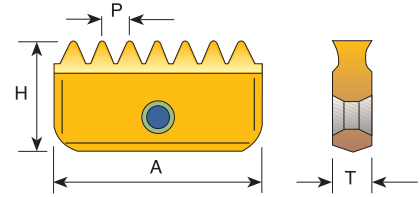

Pitch TPI	Insert Size = A		
	14	21	30
18	14-18 PG (PG 9, 11, 13.5, 16)	21-18 PG (PG 16)	
16		21-16 PG (PG 21, 29, 36, 42, 48)	30-16 PG (PG 36, 42, 48)
H	7.5	12	16
T	3.1	4.7	5.5

Order example: 21-18 PG MT7

Internal ISO Kits



MTK 12 I ISO	MTK 14 I ISO
INSERTS	INSERTS
12 I 0.75 ISO	14 I 1.0 ISO 2 Pcs
12 I 1.0 ISO 2 Pcs	14 I 1.5 ISO 2 Pcs
12 I 1.25 ISO	14 I 2.0 ISO 2 Pcs
12 I 1.5 ISO 2 Pcs	
TOOLHOLDER	TOOLHOLDER
SR 0009 H12	SR 0017 H14
KEY	KEY
K12	K14
SCREW	SCREW
S12	S14

Order example : MTK 14 I ISO

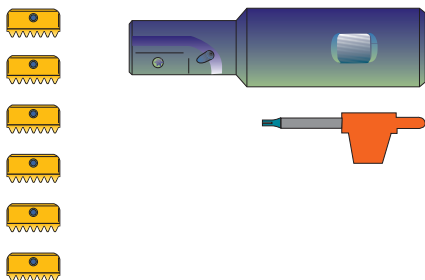

Special Tools



In addition to standard products, Carmex manufactures special tools and inserts according to customers' requests. Special tools are supplied in short delivery times.

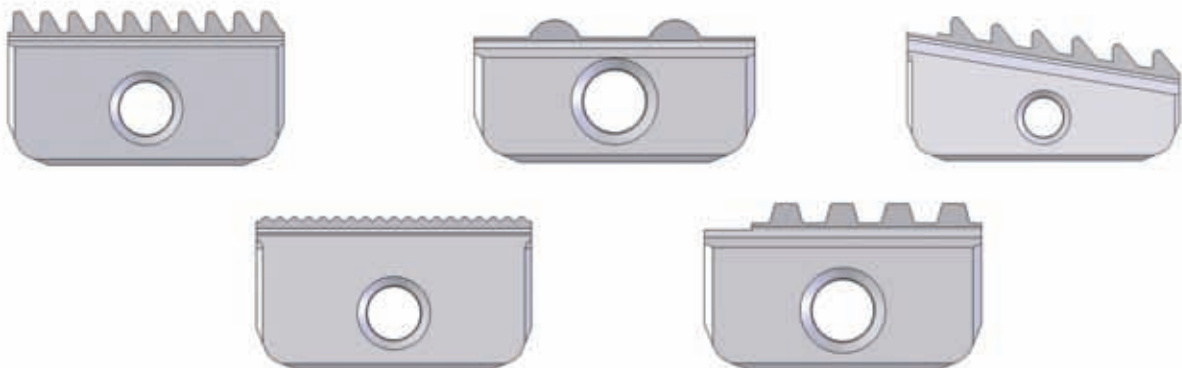



Mill-Thread Toolholders



Contents:

Page:

Product Identification	78
Single Insert Toolholders	78
Long Shank Toolholders	79
Twin Insert Toolholders	80
Multi Insert Toolholders	81
External Multi Insert Toolholders	81
Long Carbide Shank Toolholders	82
Carbide Shank Toolholders for Single Point Threading	82
D-Thread Inserts and Toolholders	83-84

Product Identification

Mill-Thread Toolholders Ordering Codes

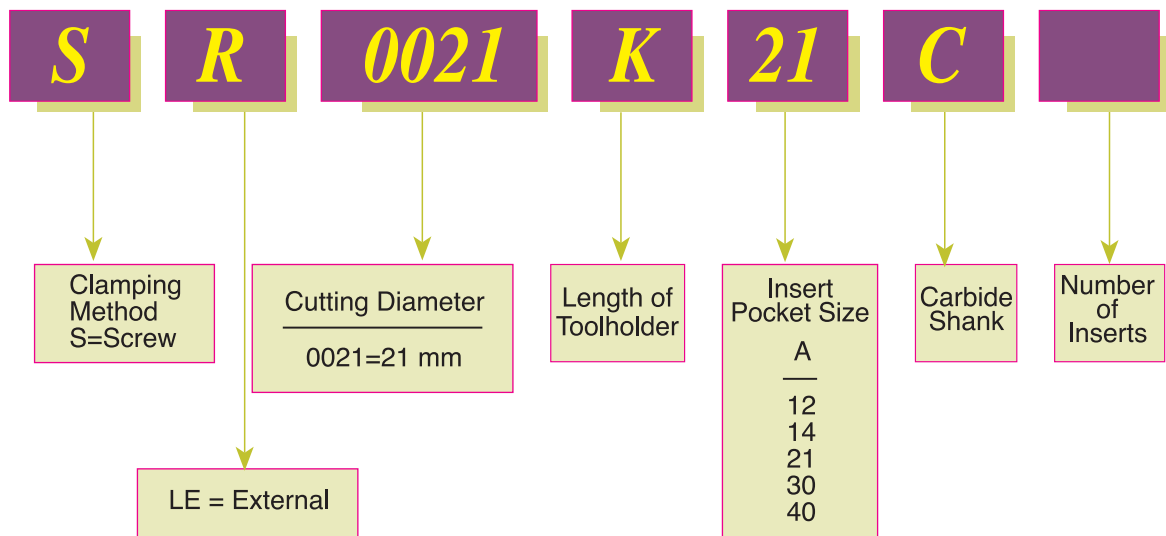

Single Insert Toolholders

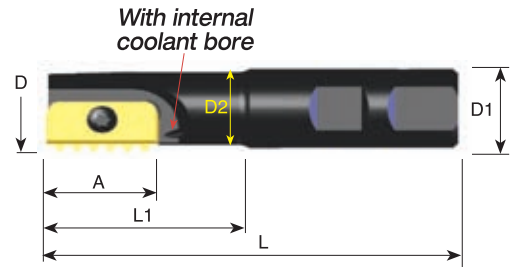

Ordering Code	A	D	D1	D2	L	L1	Insert Screw	Torx Key
SR0009H12	12	9.5	20	7.5	85	14	S12	K12
* SR0010H12	12	9.9	20	7.6	85	16	S12	K12
SR0012F14	14	12.0	20	8.9	75	20	S14	K14
SR0014H14	14	14.5	20	11.2	85	25	S14	K14
SR0017H14	14	17.0	20	13.4	85	30	S14	K14
** SR0018H21	21	18.0	20	14.4	85	30	S21	K21
SR0021H21	21	21.0	20	16.5	94	40	S21	K21
SR0029J30	30	29.0	25	22.4	110	50	S30	K30
SR0048M40	40	48.0	40	35.0	153	78	S40	K40

Order example: SR0029J30

* For conic inserts: 12-18 NPT, 12-18 NPTF, 12-19 BSPT

** Cannot be used with the following inserts:

21 I 3.5 ISO, 21I 8 UN, 21I 7 UN, 21-11 BSPT, 21-11.5 NPT, 21-11.5 NPTF

Long Shank Toolholders

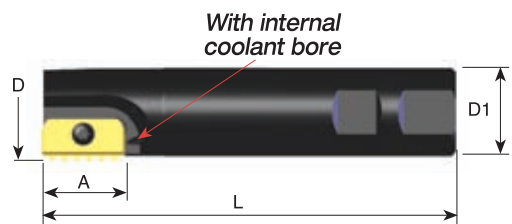

Ordering Code	A	D	D1	L	Insert Screw	Torx Key
SR0025K21	21	25	20	125	S21	K21
SR0031M30	30	31	25	150	S30	K30
SR0038M30	30	38	32	150	S30	K30
SR0048R40	40	48	40	210	S40	K40

Order example: SR0031M30

For holders with long overhang reduce the cutting speed and feed rate between 20% to 40% (depends on workpiece material, pitch and overhang)

Twin Insert Toolholders

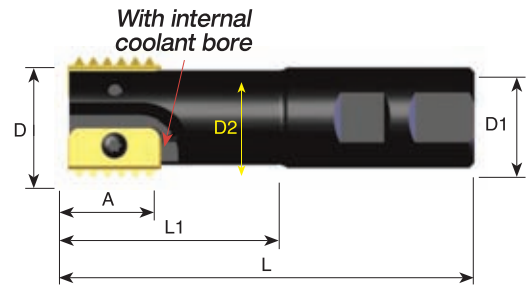

Ordering Code	A	D	D1	D2	L	L1	No. of Inserts	Insert Screw	Torx Key
SR0020H14-2	14	20	20	16	93	41	2	S14	K14
SR0030J21-2	21	30	25	24	108	52	2	S21	K21
SR0040L30-2	30	40	32	30	130	70	2	S30	K30
SR0050M40-2	40	50	40	38	153	78	2	S40	K40

Order example: SR0030J21-2

Multi Insert Toolholders

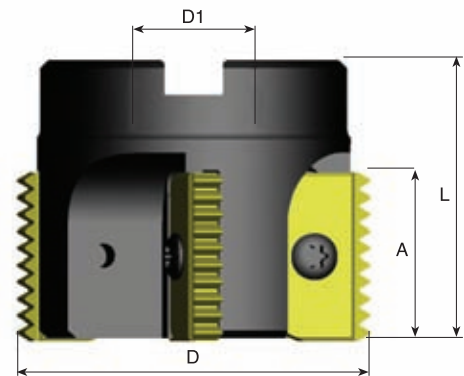

Ordering Code	A	D	D1	L	No. of Inserts	Insert Screw	Torx Key
SR0063C21-5	21	63	22	50	5	S21	K21
SR0063C30-4	30	63	22	50	4	S30	K30
SR0080D30-4	30	80	27	55	4	S30	K30
SR0100D30-4	30	100	32	60	4	S30	K30
SR0080D40-4	40	80	27	65	4	S40	K40
SR0100E40-4	40	100	32	70	4	S40	K40

Order example: SR0080D30-4

External Multi Insert Toolholder

- Reduced machining time
- Optimal coolant supply

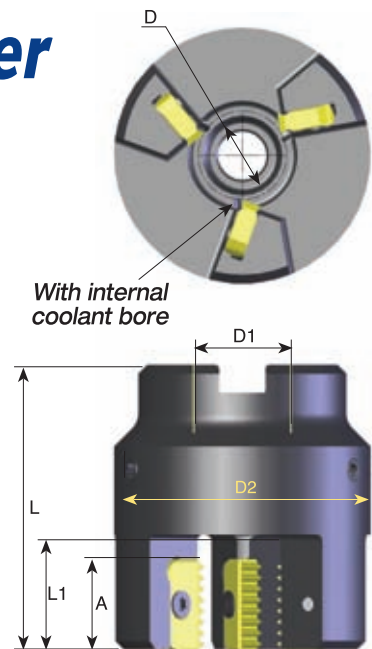

Ordering Code	A	D	D1	D2	L	L1	No. of Inserts	Insert Screw	Torx Key
SLE0020D21- 3	21	20	22	58	65	25	3	S21	K21
SLE0030D21- 3	21	30	22	68	65	25	3	S21	K21
SLE0045E21- 4	21	45	27	83	70	25	4	S21	K21

Order example: SLE 0030D21-3

Long Carbide Shank Toolholders

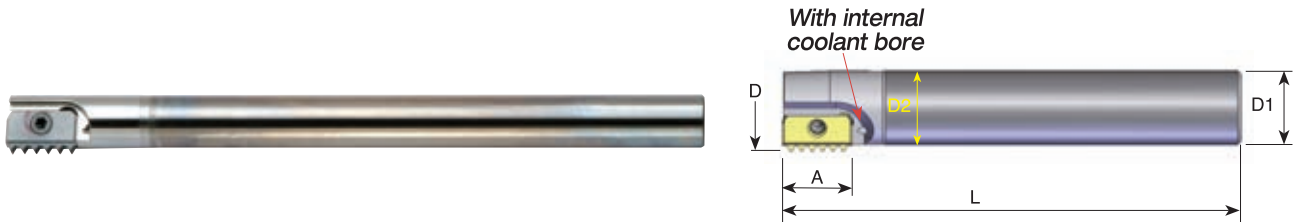

Ordering Code	A	D	D1	D2	L	Insert Screw	Torx Key
*SR0010K12C	12	9.9	8	8	125	S12	K12
SR0013H14C	14	13.2	10	10	110	S14	K14
SR0013J14C	14	13.2	10	10	150	S14	K14
SR0015K14C	14	15.2	12	12	175	S14	K14
SR0021K21C	21	21.0	16	16	130	S21	K21
SR0021M21C	21	21.0	16	16	200	S21	K21
SR0027S30C	30	27.0	20	20	270	S30	K30

Order example: SR0015K14C

* Without coolant bore

For holders with long overhang reduce the cutting speed and feed rate between 20% to 40% (depends on workpiece, material, pitch and overhang)

Carbide Shank Toolholders for Single Point Threading

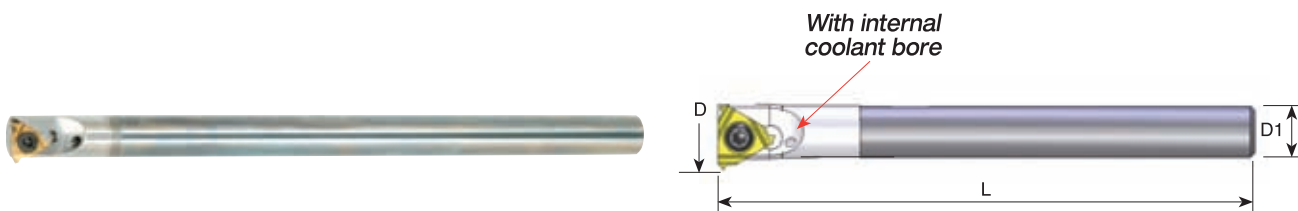

Ordering Code		Pitch Range		D	D1	L	Insert Screw	Torx Key
		mm	TPI					
* SR0005D06C	6	0.5-1.25	48-20	6.8	5.0	63	S06	K06
SR0006H08C	8	0.5-1.75	48-14	8.8	6.0	100	S08	K08
** SR0010M11C	11	0.5-2.00	48-11	13.2	10.0	150	S11	K11

For Inserts see the Threading Tools section of this Catalogue
For an internal application use an internal R.H. insert.

* Without coolant bore

** For an external application use an external L.H. insert.

D-Thread Mill-Thread Inserts & Toolholders for machining deep threads

- Improved productivity due to multi-insert toolholders.
- Partial Profile, standard or U-type inserts for a wide range of threads.
- Inserts with three cutting edges, reduces tooling costs.
- Low cutting resistance due to the single point inserts.
- Holder allows a long overhang and includes internal coolant.
- Same insert and toolholder for both external and internal thread.

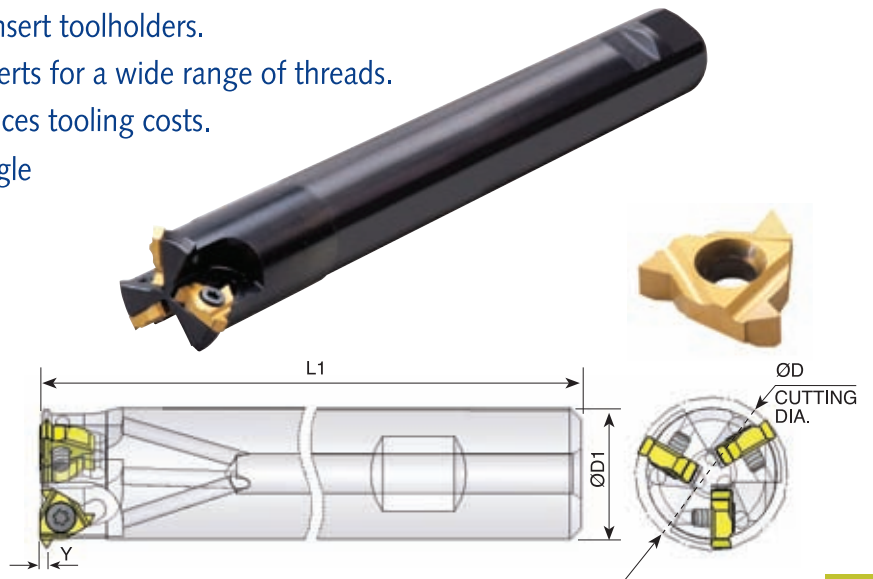

Ordering Code	Insert Size		Y	D	D1	L1	No. of Inserts	Insert Screw	Torx Key
	L	I.C.							
SR0023Q11	11	1/4	1	23.5	20	190	3	SE11	K11

Partial 60° Size 11

Ordering Code		Pitch	
		mm	TPI
1160D	INT.	1.0 -2.0	24-12
	EX.	0.75-1.5	32-14

Partial 55° Size 11

Ordering Code		Pitch TPI
1155D	INT./EX.	24-14

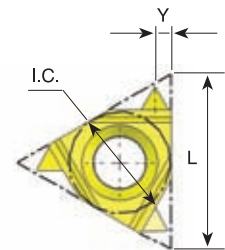

Coated Grade: BMA

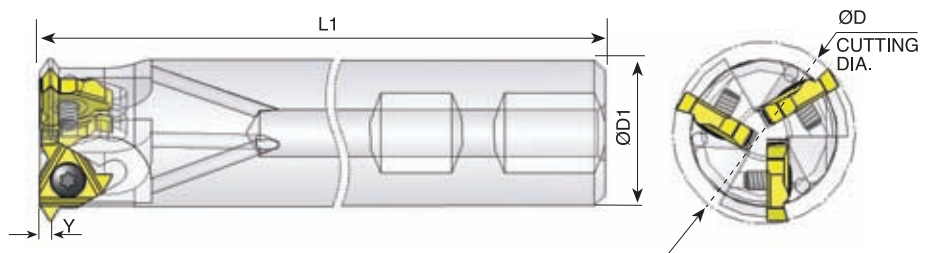

Ordering Code	Insert Size		Y	D	D1	L1	No. of Inserts	Insert Screw	Torx Key
	L	I.C.							
SR0031R16	16	3/8	1.8	31	25	225	3	SE16	K16

Partial 60° Size 16

Ordering Code		Pitch	
		mm	TPI
1660D	INT.	2.5-3.5	10-7
	EX.	2.0-3.0	12-8

Partial 55° Size 16

Ordering Code		Pitch TPI
1655D	INT./EX.	12-8

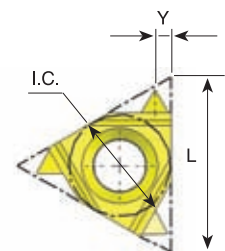

Coated Grade: BMA

D-Thread Mill-Thread Inserts & Toolholders for machining deep threads

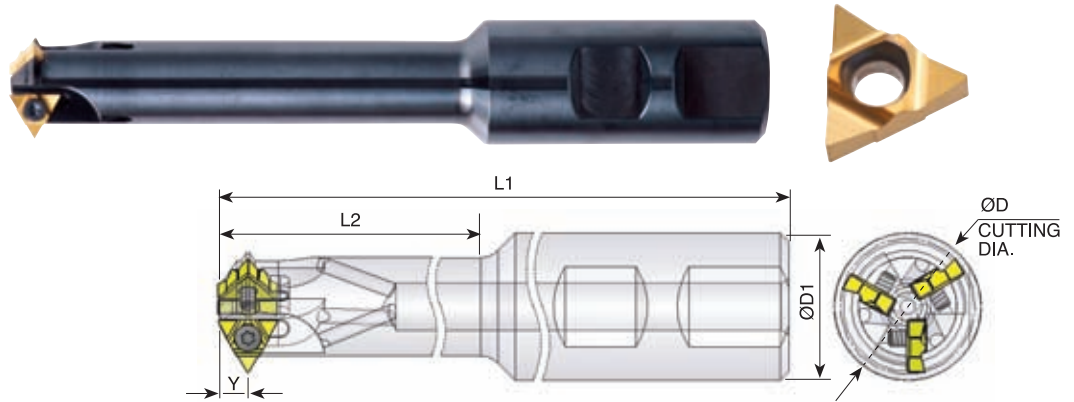

Ordering Code	Insert Size		Y	D	D1	L1	L2	No. of Inserts	Insert Screw	Torx Key
	L	I.C.								
SR0023M11U	11U	1/4U	5	23	25	150	88	3	SE11	K11

Partial 60° Size 11U

Ordering Code		Pitch	
		mm	TPI
11U60D	INT.	2.5-4.0	10-6
	EX.	2.0-3.0	12-8

Coated Grade: BMA

Partial 55° Size 11U

Ordering Code		Pitch TPI
11U55D	INT./EX.	12-7

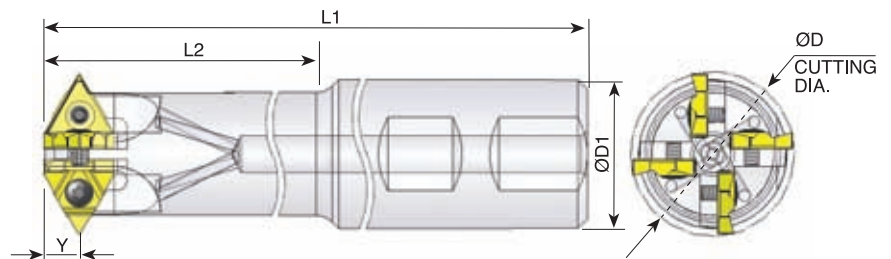
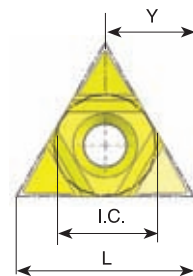

Ordering Code	Insert Size		Y	D	D1	L1	L2	No. of Inserts	Insert Screw	Torx Key
	L	I.C.								
SR0035R16U	16U	3/8U	7.6	35.5	32	220	155	4	SE16	K16

Partial 60° Size 16U

Ordering Code		Pitch	
		mm	TPI
16U60D	INT.	4.0-6.0	6-4
	EX.	3.0-5.0	8-5

Coated Grade: BMA

Partial 55° Size 16U

Ordering Code		Pitch TPI
16U55D	INT./EX.	6-4.5

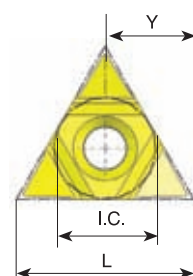

Spiral Mill-Thread



Advantages of Spiral Mill-Thread Tools

- The spiral designed tools enable a smooth cutting operation at a high feed rate and reduced machining time.
- The tools suit a wide range of applications, from machining small components in small machining centers to heavy-duty applications in high power milling machines.
- Spiral fluted toolholders hold 2 or 9 inserts in a comparatively small cutting diameter.
- The unique clamping method enables optimal indexability.
- Spiral tools reduce vibration and chatter.
- High grade finish is achieved in all applications: threading, roughing and finishing.
- Inserts are available in MT7 Sub-Micron Grade with Titanium Aluminium Nitride multi-layer coating (ISO K10 - K20). This is a general purpose grade, which can be used with all materials.

Contents:

Page:

ISO 86
UN 87
Whitworth 88
BSPT 88
NPT 89
NPTF 89
Spiral Finishing Inserts 90

Toolholders 91
Special Tools 92

ISO

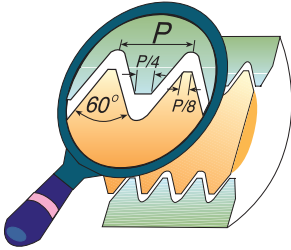

Spiral inserts have one cutting edge



Pitch mm		Insert Size H23	Thread Size	Insert Size H32	Thread Size	Insert Size H45	Thread Size	Insert Size H63	Thread Size
1.0	Ext.	H23 E 1.0 ISO							
1.0	Int.	H23 I 1.0 ISO	≥ M26	H32 I 1.0 ISO	≥ M34				
1.5	Ext.	H23 E 1.5 ISO		H32 E 1.5 ISO		H45 E 1.5 ISO			
1.5	Int.	H23 I 1.5 ISO	≥ M27	H32 I 1.5 ISO	≥ M35	H45 I 1.5 ISO	≥ M50	H63 I 1.5 ISO	≥ M68
2.0	Ext.	H23 E 2.0 ISO		H32 E 2.0 ISO		H45 E 2.0 ISO			
2.0	Int.	H23 I 2.0 ISO	≥ M28	H32 I 2.0 ISO	≥ M36	H45 I 2.0 ISO	≥ M50	H63 I 2.0 ISO	≥ M70
3.0	Ext.	H23 E 3.0 ISO		H32 E 3.0 ISO					
3.0	Int.	H23 I 3.0 ISO	≥ M30	H32 I 3.0 ISO	≥ M38	H45 I 3.0 ISO	≥ M52	H63 I 3.0 ISO	≥ M70
3.5	Ext.								
3.5	Int.	H23 I 3.5 ISO	≥ M30	H32 I 3.5 ISO		H45 I 3.5 ISO			
4.0	Ext.			H32 E 4.0 ISO					
4.0	Int.	H23 I 4.0 ISO	≥ M36	H32 I 4.0 ISO	≥ M40	H45 I 4.0 ISO	≥ M56	H63 I 4.0 ISO	≥ M72
4.5	Ext.								
4.5	Int.			H32 I 4.5 ISO	≥ M42	H45 I 4.5 ISO			
5.0	Ext.								
5.0	Int.			H32 I 5.0 ISO	≥ M48	H45 I 5.0 ISO			
5.5	Ext.								
5.5	Int.					H45 I 5.5 ISO	≥ M56		
6.0	Ext.								
6.0	Int.					H45 I 6.0 ISO	≥ M64	H63 I 6.0 ISO	≥ M76

Toolholder	SRH23-2	SRH32-5	SRH45-6	SRH63-9
		SRH32-5 M	SRH45-6 M	

Spiral Mill - Thread Inserts

UN

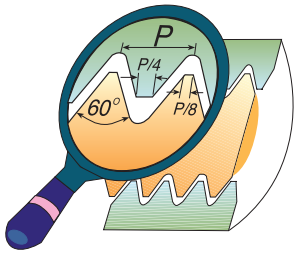

Spiral inserts have one cutting edge

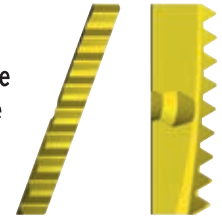

Pitch TPI		Insert Size H23	Thread Size	Insert Size H32	Thread Size	Insert Size H45	Thread Size	Insert Size H63	Thread Size
32	Ext.								
32	Int.	H23 I 32 UN	≥ 1"						
24	Ext.			H32 E 24 UN					
24	Int.	H23 I 24 UN	≥ 1"						
20	Ext.	H23 E 20 UN		H32 E 20 UN					
20	Int.	H23 I 20 UN	≥ 1"	H32 I 20 UN	≥ 1 3/8"				
18	Ext.	H23 E 18 UN		H32 E 18 UN					
18	Int.	H23 I 18 UN	≥ 1 1/16"	H32 I 18 UN	≥ 1 3/8"				
16	Ext.	H23 E 16 UN		H32 E 16 UN					
16	Int.	H23 I 16 UN	≥ 1 1/16"	H32 I 16 UN	≥ 1 3/8"	H45 I 16 UN	≥ 2"	H63 I 16 UN	≥ 2 3/4"
14	Ext.	H23 E 14 UN							
14	Int.	H23 I 14 UN	≥ 1 1/8"						
12	Ext.	H23 E 12 UN		H32 E 12 UN					
12	Int.	H23 I 12 UN	≥ 1 1/8"	H32 I 12 UN	≥ 1 7/16"	H45 I 12 UN	≥ 2"	H63 I 12 UN	≥ 2 3/4"
10	Ext.	H23 E 10 UN							
10	Int.	H23 I 10 UN	≥ 1 1/8"						
8	Ext.	H23 E 8 UN		H32 E 8 UN					
8	Int.	H23 I 8 UN	≥ 1 3/16"	H32 I 8 UN	≥ 1 1/2"	H45 I 8 UN	≥ 2 1/4"	H63 I 8 UN	≥ 3"
7	Ext.	H23 E 7 UN							
7	Int.	H23 I 7 UN	≥ 1 1/4"						
6	Ext.			H32 E 6 UN					
6	Int.			H32 I 6 UN	≥ 1 5/8"	H45 I 6 UN	≥ 2 1/4"	H63 I 6 UN	≥ 3"
5	Ext.								
5	Int.			H32 I 5 UN	≥ 1 3/4"				
4.5	Ext.								
4.5	Int.					H45 I 4.5 UN	≥ 2 1/4"		
4	Ext.								
4	Int.					H45 I 4 UN	≥ 2 1/2"	H63 I 4 UN	≥ 3"
Toolholder	SRH23-2			SRH32-5		SRH45-6		SRH63-9	
				SRH32-5 M		SRH45-6 M			

Whitworth

Same insert for internal and external thread

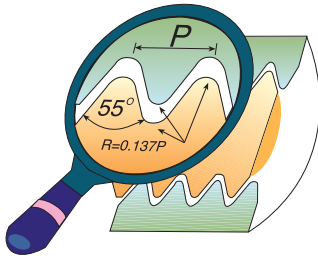

Spiral inserts have one cutting edge

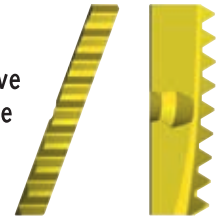

Pitch TPI	Insert Size H23	Thread Size	Insert Size H32	Thread Size	Insert Size H45	Thread Size	Insert Size H63	Thread Size
14	H23-14 W	Int. $\geq G 7/8"$ Ex. $\geq G 1/2"$	H32-14 W	Ex. $\geq G 1/2"$				
11	H23-11 W	$\geq G 1"$	H32-11 W	Int. $\geq G 1 1/8"$ Ex. $\geq G 1"$	H45-11 W	Int. $\geq G 1 5/8"$ Ex. $\geq G 1"$	H63-11 W	Int. $\geq G 2 3/8"$ Ex. $\geq G 1"$
Toolholder	SRH23-2		SRH32-5		SRH45-6		SRH63-9	
			SRH32-5 M		SRH45-6 M			

BSPT

Same insert for internal and external thread

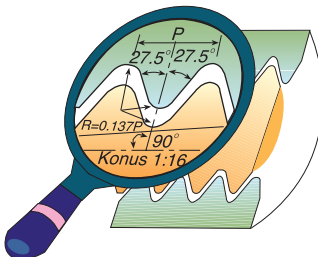

Spiral inserts have one cutting edge

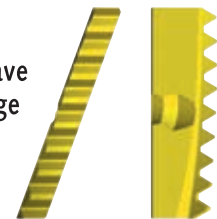

Pitch TPI	Insert Size H23	Thread Size	Insert Size H32	Thread Size	Insert Size H45	Thread Size	Insert Size H23	Thread Size
11	H23-11 BSPT	$\geq 1"$ BSPT	H32-11 BSPT	Int. $\geq 1 1/8"$ BSPT Ex. $\geq 1"$ BSPT	H45-11 BSPT	Int. $\geq 1 3/4"$ BSPT Ex. $\geq 1"$ BSPT	H63-11 BSPT	Int. $\geq 2 1/2"$ BSPT Ex. $\geq 1"$ BSPT
Toolholder	SRH23-2		SRH32-5		SRH45-6		SRH63-9	
			SRH32-5 M		SRH45-6 M			

NPT

Same insert for internal and external thread

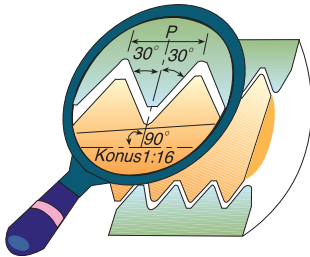

Spiral inserts have one cutting edge

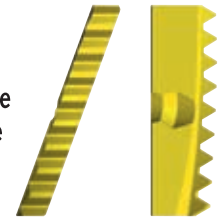

Pitch TPI	Insert Size H23	Thread Size	Insert Size H32	Thread Size	Insert Size H45	Thread Size	Insert Size H63	Thread Size
11.5	H23-11.5 NPT	1" - 2" NPT	H32-11.5 NPT	Int. 1 1/4" - 2" NPT Ext. 1" - 2" NPT	H45-11.5 NPT	Int. 2" NPT Ext. 1" - 2" NPT	H63-11.5 NPT	Ext. 1" - 2" NPT
8					H45 - 8 NPT	2 1/2" - 3" NPT	H63 - 8 NPT	2 1/2" - 3" NPT
Toolholder	SRH23-2		SRH32-5		SRH45-6		SRH63-9	
			SRH32-5 M		SRH45-6 M			

NPTF

Same insert for internal and external thread

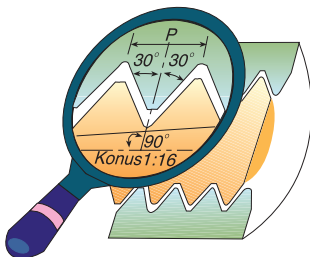

Spiral inserts have one cutting edge



Pitch TPI	Insert Size H23	Thread Size	Insert Size H32	Thread Size
11.5	H23-11.5 NPTF	1" - 2" NPTF	H32-11.5 NPTF	Int. 1 1/4" - 2" NPTF Ext. 1" - 2" NPTF
Toolholder	SRH23-2		SRH32-5	
			SRH32-5 M	

Spiral Finishing Inserts

Spiral inserts have one cutting edge

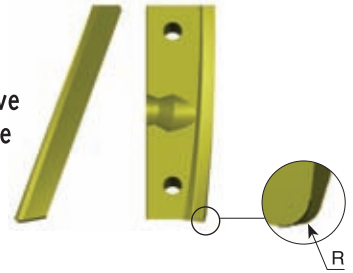

R	Insert Size H23	Insert Size H32	Insert Size H45	Insert Size H63
0.2	H23 F R 0.2	H32 F R 0.2	H45 F R 0.2	H63 F R 0.2
0.5	H23 F R 0.5	H32 F R 0.5	H45 F R 0.5	H63 F R 0.5
1.0	H23 F R 1.0	H32 F R 1.0	H45 F R 1.0	H63 F R 1.0
1.5			H45 F R 1.5	H63 F R 1.5
2.0			H45 F R 2.0	H63 F R 2.0

Toolholder	SRH23-2	SRH32-5	SRH45-6	SRH63-9
		SRH32-5 M	SRH45-6 M	

Spiral Toolholders

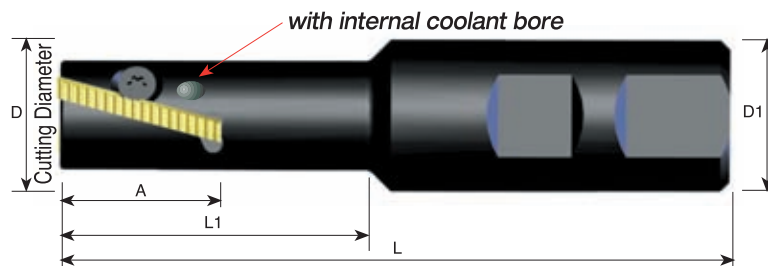

Ordering Code	Insert Size A	D	D1	L	L1	No. of Inserts	Screw	Key
SRH23-2	27	23	25	110	50	2	S23	K21

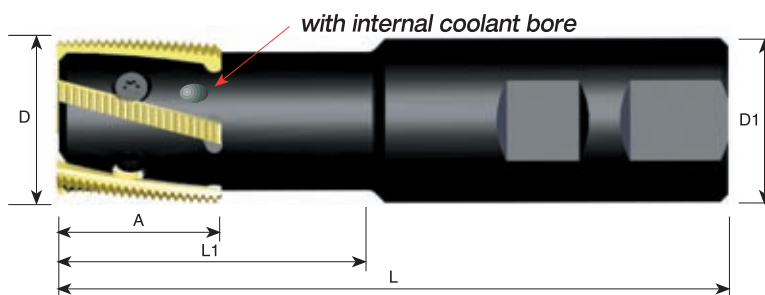

Ordering Code	Insert Size A	D	D1	L	L1	No. of Inserts	Screw	Key
SRH32-5	32	32	32	130	60	5	S32	K22

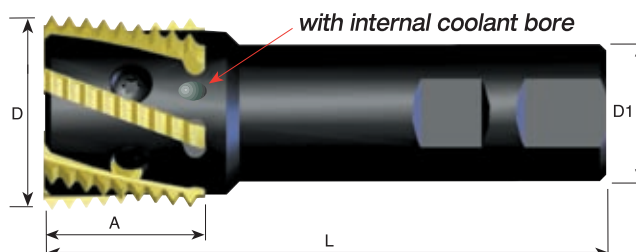

Ordering Code	Insert Size A	D	D1	L	No. of Inserts	Screw	Key
SRH45-6	37	45	32	130	6	S45	K40

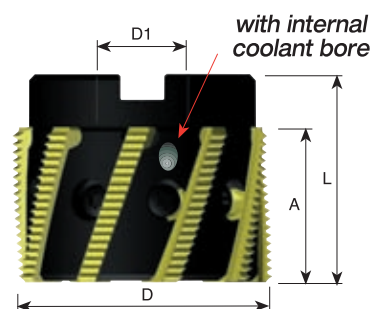

Ordering Code	Insert Size A	D	D1	L	No. of Inserts	Screw	Key
SRH32-5 M	32	32	16	52	5	S32S	K22
SRH45-6 M	37	45	22	60	6	S45S	K40
SRH63-9	38	63	22	50	9	S63	K40

MT7 Inserts are available in MT7 Sub-Micron Grade with Titanium Aluminium Nitride multi-layer coating (ISO K10 - K20). This is a general purpose grade, which can be used with all materials.

Special Tools

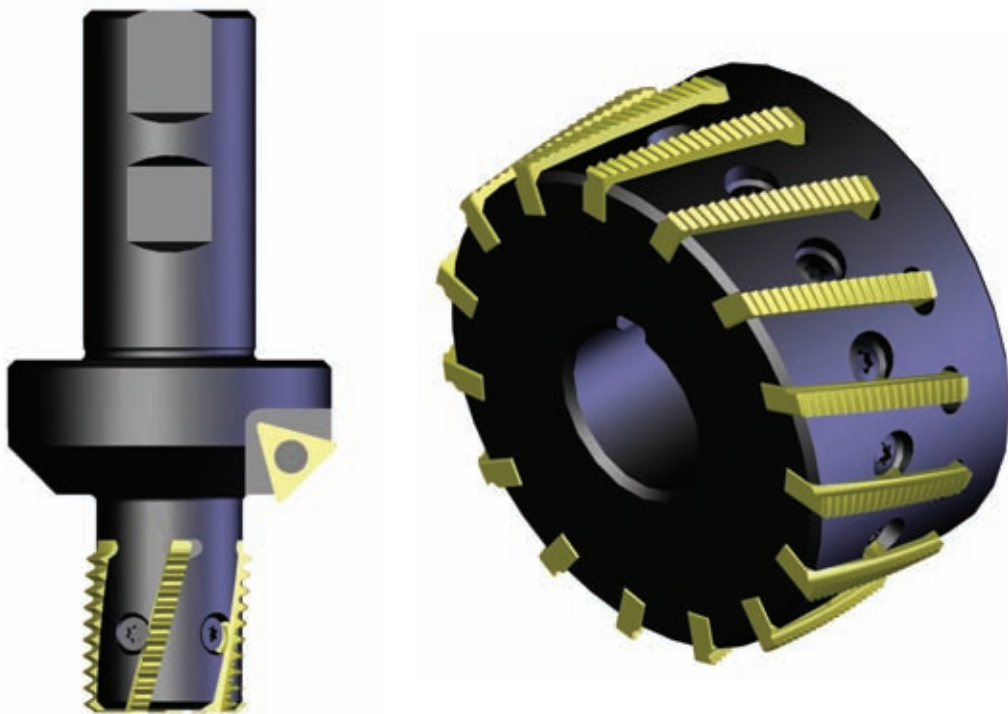

In addition to standard products, Carmex manufactures special tools and inserts according to customers' requests. The toolholders are multi-purpose, making them suitable for both roughing and finishing inserts. Special tools are supplied in short delivery times.



CMT Vertical Mill-Thread



Carmex presents a new family of vertical thread milling indexable inserts and toolholders to perform a wide variety of threads.



Advantages of CMT - Vertical Mill-Thread

- Ground profile inserts for high precision and excellent performance.
- Working at high machining parameters, with high surface quality.
- Solid and accurate clamping method enables full repeatability.
- Same insert for right-hand or left-hand threads.
- Toolholders include built-in weldon and coolant bore.
- Chamfer inserts are also available.

Contents:	Page:	Contents:	Page:
Product Identification	94	Trapez - DIN 103	98
Partial Profile 60°	95	Chamfering and Grooving	98
Partial Profile 55°	95	Groove Milling	99
ISO	96	Face Milling and Grooving	99
UN	97	Toolholders - with Coolant Bore	100
G 55°	98	Carbide Shank Toolholder	101

Product Identification

CMT Ordering Codes

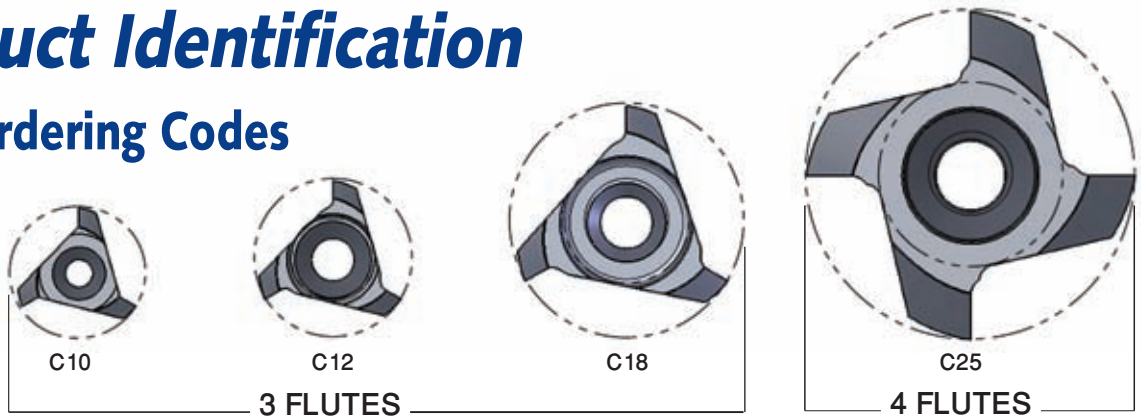

Inserts

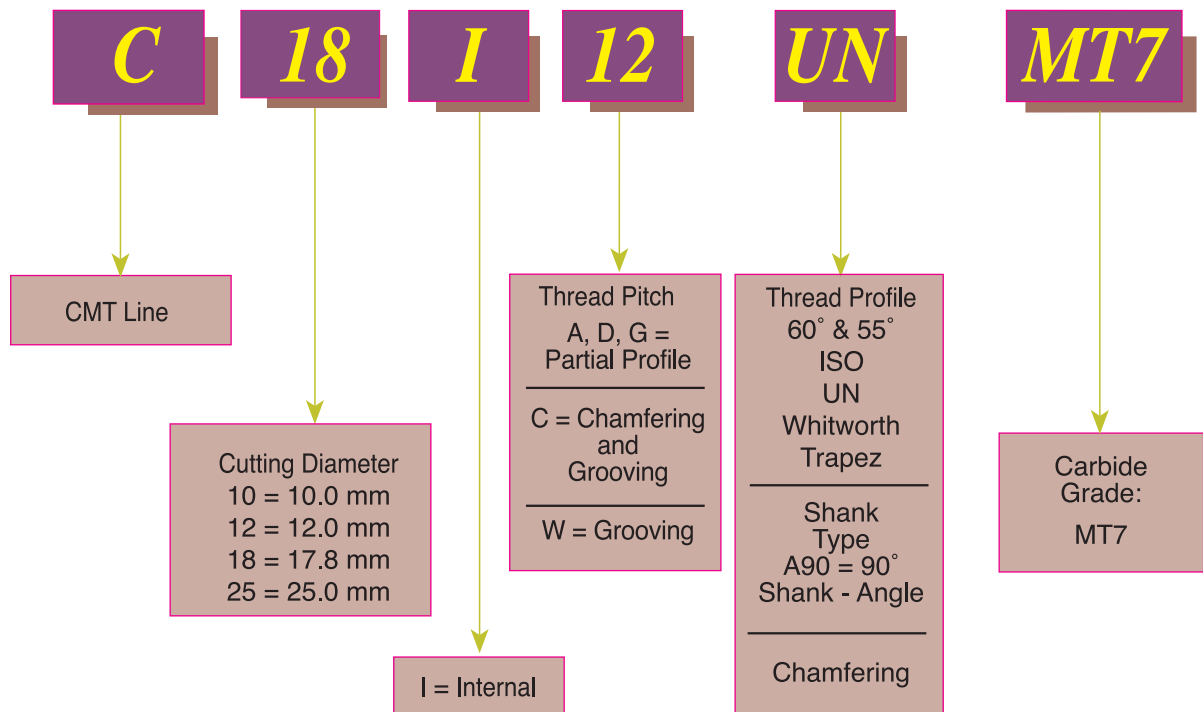

Toolholders

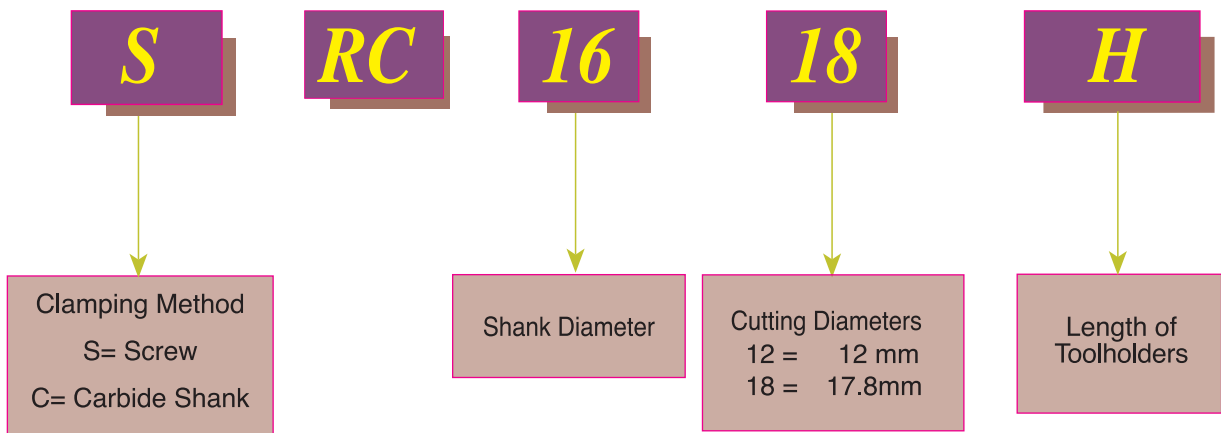

Partial Profile 60°

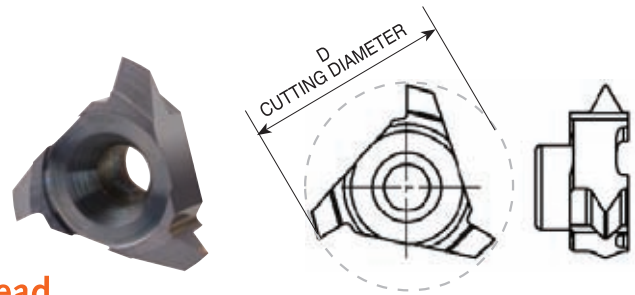

Same insert for internal and external thread

Insert Type	Pitch Range mm	Pitch Range TPI	Ordering Code	D	Thread Dia. (min)		Holder Code*
					Pitch Low range	Pitch High range	
C10	Int. 0.5 - 0.8	56 - 28	C10 A60	10.0	$\varnothing \geq 11$	$\varnothing \geq 12$	H1, 2, 12, 13
	Ex. 0.4 - 0.8	64 - 32					
	Int. 1.0 - 2.0	28 - 13	C10 G60		$\varnothing \geq 12$	$\varnothing \geq 14$	
	Ex. 0.8 - 1.75	32 - 15					
C12	Int. 0.5 - 0.8	56 - 28	C12 A60	12.0	$\varnothing \geq 13$	$\varnothing \geq 14$	H3, 4, 5, 14
	Ex. 0.4 - 0.8	64 - 32					
	Int. 1.0 - 2.0	28 - 13	C12 G60		$\varnothing \geq 14$	$\varnothing \geq 16$	
	Ex. 0.8 - 1.75	32 - 15					
C18	Int. 0.5 - 0.8	56 - 28	C18 A60	17.8	$\varnothing \geq 19$		H6, 7, 8, 9, 15
	Ex. 0.4 - 0.8	64 - 32					
	Int. 1.0 - 1.75	28 - 14	C18 G60		$\varnothing \geq 20$	$\varnothing \geq 21$	
	Ex. 0.8 - 1.5	32 - 16			$\varnothing \geq 21$	$\varnothing \geq 23$	
	Int. 2.0 - 3.0	13 - 8	C18 D60		$\varnothing \geq 21$	$\varnothing \geq 23$	
Ex. 1.75 - 2.5	15 - 10						
C25	Int. 1.5 - 2.5	16 - 10	C25 G60	25.0	$\varnothing \geq 28$	$\varnothing \geq 30$	H10, 11, 16, 17
	Ex. 1.0 - 2.0	28 - 13					
	Int. 3.0 - 5.0	8 - 5	C25 N60		$\varnothing \geq 30$	$\varnothing \geq 34$	
	Ex. 2.5 - 4.5	10 - 6			$\varnothing \geq 34$	$\varnothing \geq 35$	
	Int. 5.0 - 6.0	5 - 4	C25 Q60		$\varnothing \geq 34$	$\varnothing \geq 35$	
Ex. 4.5 - 5.0	6 - 5						

Partial Profile 55°

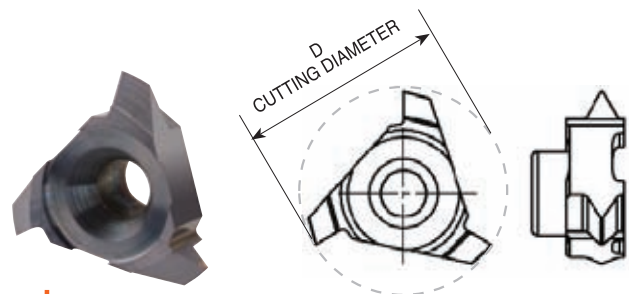

Same insert for internal and external thread

Insert Type	Pitch Range TPI	Ordering Code	D	Thread Dia. (min)	Holder Code*
C10	19-14	C10 G55	10.0	$\varnothing \geq 13$	H1, 2, 12,
C12	28 - 19	C12 G55	12.0	$\varnothing \geq 14$	H3, 4, 5, 14
	14-11	C12 N55	12.2	$\varnothing \geq 16$	H3, 4, 5
C18	14 - 8	C18 G55	18.0	$\varnothing \geq 23$	H6, 7, 8, 9, 15
C25	7-5	C25 N55	25.0	$\varnothing \geq 31$	H10, 11, 16, 17

* For complete toolholder description see pages 100 and 101

Full Profile

ISO

Inserts for internal thread

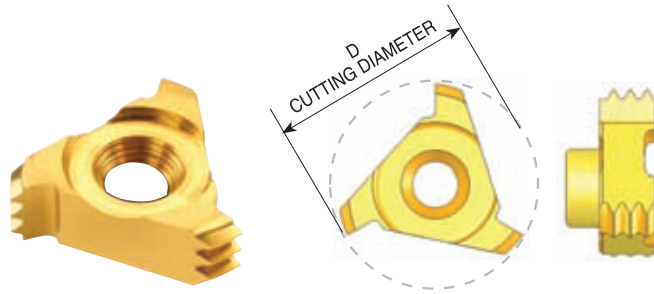

Insert Type	Pitch mm	M coarse	M fine	Ordering Code	Number of Teeth	D	Holder Code*
C10	0.5		$\varnothing \geq 10$	C10 I 0.5 ISO	5	9.0	H1, 2, 12, 13
	1.0		$\varnothing \geq 12$	C10 I 1.0 ISO	3	10.0	
	1.5		$\varnothing \geq 13$	C10 I 1.5 ISO	2		H1, 2, 12
	2.0	M14	$\varnothing \geq 14$	C10 I 2.0 ISO	1		
C12	0.5		$\varnothing \geq 13$	C12 I 0.5 ISO	6	12.0	H3, 4, 5, 14
	0.75		$\varnothing \geq 13$	C12 I 0.75 ISO	4		
	1.0		$\varnothing \geq 14$	C12 I 1.0 ISO	3		
	1.5		$\varnothing \geq 15$	C12 I 1.5 ISO	2		
	2.0	M16	$\varnothing \geq 16$	C12 I 2.0 ISO	1	12.4	H3, 4, 5
	2.5	M18, M20	$\varnothing \geq 17$	C12 I 2.5 ISO	1	12.0	
	3.0		$\varnothing \geq 17$	C12 I 3.0 ISO	1	12.4	
C18	0.5		$\varnothing \geq 19$	C18 I 0.5 ISO	9	17.8	H6, 7, 8, 9, 15
	0.75		$\varnothing \geq 19$	C18 I 0.75 ISO	6		
	1.0		$\varnothing \geq 20$	C18 I 1.0 ISO	5		
	1.5		$\varnothing \geq 20$	C18 I 1.5 ISO	3		
	2.0		$\varnothing \geq 21$	C18 I 2.0 ISO	2		
	2.5	M22	$\varnothing \geq 22$	C18 I 2.5 ISO	2		
	3.0	M24, M27	$\varnothing \geq 23$	C18 I 3.0 ISO	1		
	3.5	M30, M33	$\varnothing \geq 24$	C18 I 3.5 ISO	1		
C25	3.0	M32, M33	$\varnothing \geq 30$	C25 I 3.0 ISO	2	25.0	H10, 11, 16, 17
	4.0	M36, M39	$\varnothing \geq 32$	C25 I 4.0 ISO	1		
	4.5	M45	$\varnothing \geq 33$	C25 I 4.5 ISO	1		
	5.0	M48, M52	$\varnothing \geq 34$	C25 I 5.0 ISO	1		
	5.5	M60	$\varnothing \geq 35$	C25 I 5.5 ISO	1		
	6.0	M64, M68	$\varnothing \geq 36$	C25 I 6.0 ISO	1		

* For complete toolholder description see pages 100 and 101

Full Profile

UN

Inserts for internal thread

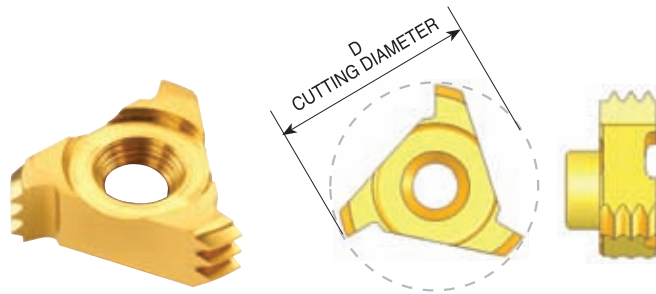

Insert Type	Pitch TPI	Nominal Size	UNC	UNF	UNEF	Ordering Code	Number of Teeth	D	Holder Code*
C10	20			1/2		C10 I 20 UN	2	10.0	H1, 2, 12, 13
	18			9/16		C10 I 18 UN	2		
	12	5/8, 11/16, 3/4	9/16			C10 I 12 UN	1		
C12	32	9/16, 5/8				C12 I 32 UN	3	12.0	H3, 4, 5, 14
	28	9/16, 5/8, 11/16				C12 I 28 UN	3		
	24				9/16, 5/8, 11/16	C12 I 24 UN	2		
	20	9/16, 5/8, 11/16			3/4	C12 I 20 UN	2		
	18			5/8		C12 I 18 UN	2		
	16	5/8, 11/16		3/4		C12 I 16 UN	1		
	11		5/8			C12 I 11 UN	1		H3, 4, 5
10		3/4			C12 I 10 UN	1			
C18	32	3/4, 13/16, 7/8				C18 I 32 UN	6	17.8	H6, 7, 8, 9, 15
	28	3/4, 13/16, 7/8				C18 I 28 UN	5		
	24					C18 I 24 UN	4		
	20	11/16, 11/8			13/16, 7/8, 15/16	C18 I 20 UN	3		
	18					C18 I 18 UN	3		
	16	7/8, 1				C18 I 16 UN	3		
	14			7/8		C18 I 14 UN	2		
	12	7/8		1, 11/8		C18 I 12 UN	2		
	11					C18 I 11 UN	2		
C25	8	13/16, 11/4, 15/16				C25 I 8 UN	2	25.0	H10, 11, 16, 17
	7		11/4			C25 I 7 UN	1		
	6	17/16, 19/16	13/8, 11/2			C25 I 6 UN	1		
	5		13/4			C25 I 5 UN	1		
	4		21/2, 23/4			C25 I 4 UN	1		

* For complete toolholder description see pages 100 and 101

G 55° BSW, BSF, BSP

Same Insert for internal and external thread

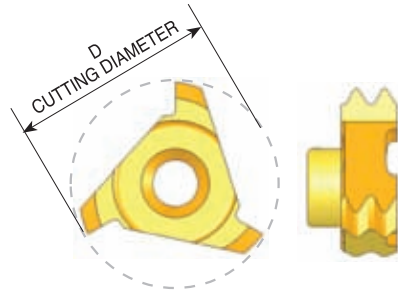

Insert Type	Pitch TPI	Standard	Ordering Code	Number of Teeth	D	Holder Code*
C10	19	G ¹ / ₄	C10 19 W	2	10.0	H1, 2, 12, 13
C12	19	G ³ / ₈	C12 19 W	2	12.0	H3, 4, 5, 14
C18	14	G ⁷ / ₈	C18 14 W	2	17.8	H6, 7, 8, 9, 15
	11	G [≥] 1	C18 11 W	2		

Trapez - DIN 103

Inserts for internal thread

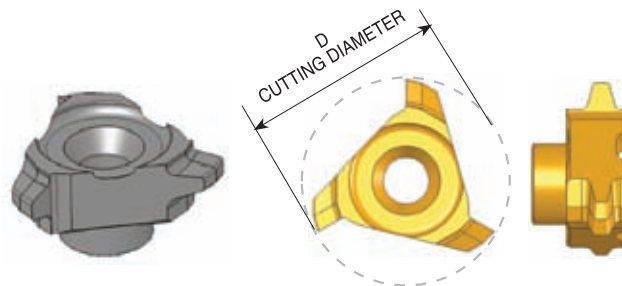

Insert Type	Pitch mm	Minimum Thread Dia.	Ordering Code	D	Holder Code*
C10	2.0	∅ ≥ 16	C 10 I 2TR	10.0	H1, 2, 12
C18	3.0	∅ ≥ 24	C 18 I 3TR	17.8	H6, 7, 8, 9, 15
	4.0	∅ ≥ 26	C 18 I 4TR		H15
	5.0	∅ ≥ 28	C 18 I 5TR		
C25	6.0	∅ ≥ 36	C 25 I 6TR	25.0	H10, 11, 16, 17

* For complete toolholder description see pages 100 and 101

Chamfering and Grooving

- Optimal for deburring, back chamfering and grooving
- Double side cutting
- General purpose for all materials

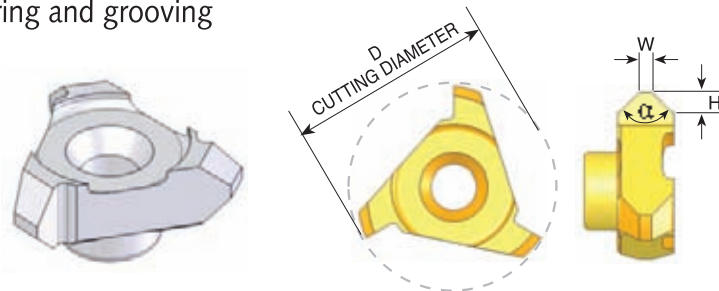

Insert Type	Ordering Code	D	H	W	α	Holder Code*
C10	C10 C90	10.0	1.30	0.4	90°	H1, 2, 12
C12	C12 C90	12.0	1.35	0.3		H3, 4, 5
C18	C18 C90	17.8	1.95	1.1		H6, 7, 8, 9, 15
C25	C25 C90	25.0	2.50	1.0		H10, 11, 16, 17

Groove Milling

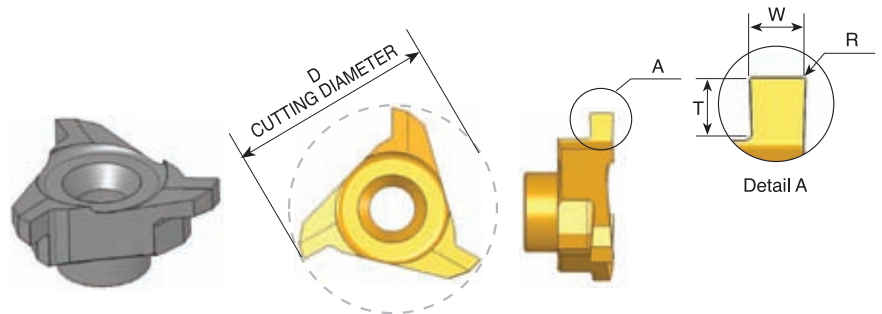

Insert Type	Ordering Code	D	W ±0.02	T max.	R	Groove Dia. (min)	Holder Code*
C10	C10 W08	10.0	0.80	0.80	0.1	∅ >10.0	H1, 2, 12, 13
	C10 W09		0.90	0.90			
	C10 W10		1.00	0.90			
C12	C12 W08	12.0	0.80	0.80	0.1	∅ >12.0	H3, 4, 5, 14
	C12 W10		1.00	0.90			
C18	C18 W10	17.8	1.00	1.50	0.1	∅ >17.8	H6, 7, 8, 9, 15
	C18 W12		1.20	1.50			
	C18 W15		1.50	1.95			
	C18 W20		2.00	2.80			H15
C25	C25 W20	25.0	2.00	3.00	0.2	∅ > 25.0	H10, 11, 16, 17
	C25 W25		2.50	3.00			
	C25 W30		3.00	3.00			
	C25 W35		3.50	3.50			
	C25 W40		4.00	3.50			
	C25 W50		5.00	3.50			

* For complete toolholder description see pages 100 and 101

Face Milling and Finishing

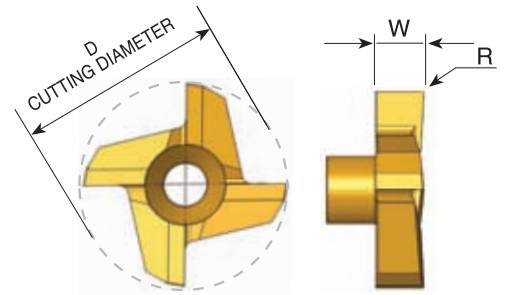
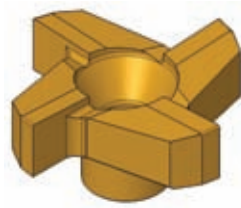

Insert Type	Ordering Code	D	W	R	Holder Code
C18	C18 F R 0.1	17.8	5.0	0.1	H6, 7, 8, 9, 15
C25	C25 F R 0.2	25.0	6.0	0.2	H10, 11, 16, 17

Steel Toolholders

With internal coolant

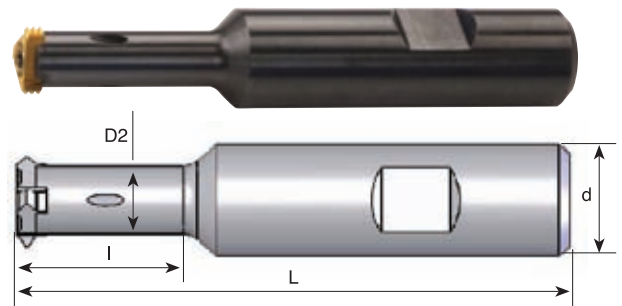

Tool No.	Ordering Code	Insert type	d	D2	I	L	Insert Screw	Torx Key
H1	SRC 1210 E	C10	12	7.3	19	70	S5	K5
H2	SRC 1610 G		16		19	90		
H3	SRC 1212 E	C12	12	9.0	25	70	S10	K10
H4	SRC 1612 G		16		25	90		
H5	SRC 1612 H		16		35	100		
H6	SRC 1618 H	C18	16	13.8	48	100	S16	K16
H7	SRC 2018 H		20		32	100		
H8	SRC 2018 J		20		48	110		
H9	SRC 2018 L		20		74	140		
H10	SRC 2525 J	C25	25	17.5	45	115	S27	K27
H11	SRC 2525 M		25		80	150		

Carbide Shank Toolholders

With internal coolant

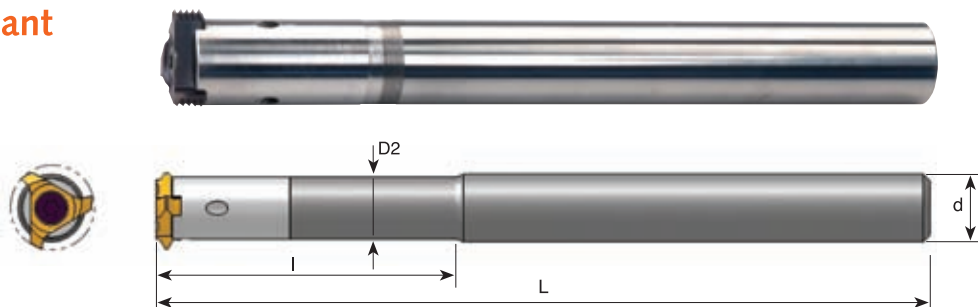

Tool No.	Ordering Code	Insert type	d	D2	I	L	Insert Screw	Torx Key
H12	CRC 0810 L35 K	C10	8	7.3	35	125	S5	K5
H13	CRC 0810 K		8	8.0	-	125		
H14	CRC 1012 M	C12	10	10.0	-	150	S10	K10
H15	CRC 1218 P	C18	12	12.0	-	170	S16	K16
H16	CRC 1625 R	C25	16	16.0	-	205	S27	K27
H17	CRC 2025 L85 S		20	17.5	85	250		

* Toolholders without Weldon

Mill-Thread Solid Carbide



Advantages of Mill-Thread Solid Carbide

Carbide grade: MT7 Sub-micron grade with Titanium Aluminium Nitride multi-layer coating (ISO K10-K20). To be run at medium to high cutting speeds. General purpose for all materials.

- Thread is generated in one pass.
- Spiral flutes allow smooth cutting action.
- Shorter machining time due to multi, 3 to 6, flutes.
- 2.2 mm and up cutting diameter.
- Threads up to shoulder in blind holes.
- Longer tool life due to special multi-layer coating.
- Same tool can be used for a variety of materials.
- Excellent surface finish.
- Low cutting pressure allows thin wall machining.
- Same tool used for R.H. and L.H. threads.

Thread Mills with Internal Coolant

- Coolant fluid washes the chips out of hole
- Increased tool life

MTB - Thread Mills with internal coolant bore for blind holes

MTZ - Thread Mills with internal coolant through the flutes

MTQ - Thread Mills that include relieved neck for deep work pieces

Contents:

Page:

Contents:

Page:

Product Identification	104
ISO	105
ISO - with Coolant Bore - MTB	106
ISO - with Internal Coolant through the flutes - MTZ	107
ISO - with Internal Coolant Bore - MTQ	108
G (55°)	109
G (55°) - with Internal Coolant Bore - MTB	109
G (55°) - with Internal Coolant through the flutes - MTZ	110
Whitworth - with Internal Coolant through the flutes - MTZ	110
UN	111
UN - with Coolant Bore - MTB	112
UN - with Internal Coolant through the flutes - MTZ	113
UN - with Relieved Neck & Internal Coolant Bore - MTQ	114
BSPT	115
BSPT - with Coolant Bore - MTB	115

BSPT - with Internal Coolant through the flutes - MTZ	115
NPT	116
NPT - with Coolant Bore - MTB	116
NPT - with Internal Coolant through the flutes - MTZ	117
NPTF	117
NPTF - with Coolant Bore - MTB	118
NPTF - with Internal Coolant through the flutes - MTZ	118
NPS - with Coolant Bore - MTB	119
NPSF - with Coolant Bore - MTB	119
PG DIN 40430 - with Coolant Bore	120
Solid Carbide Tapered End Mills	121
Mill - Thread Solid Carbide for External Threads	
ISO	122
UN	122

Product Identification

Mill-Thread Solid Carbide Ordering Codes

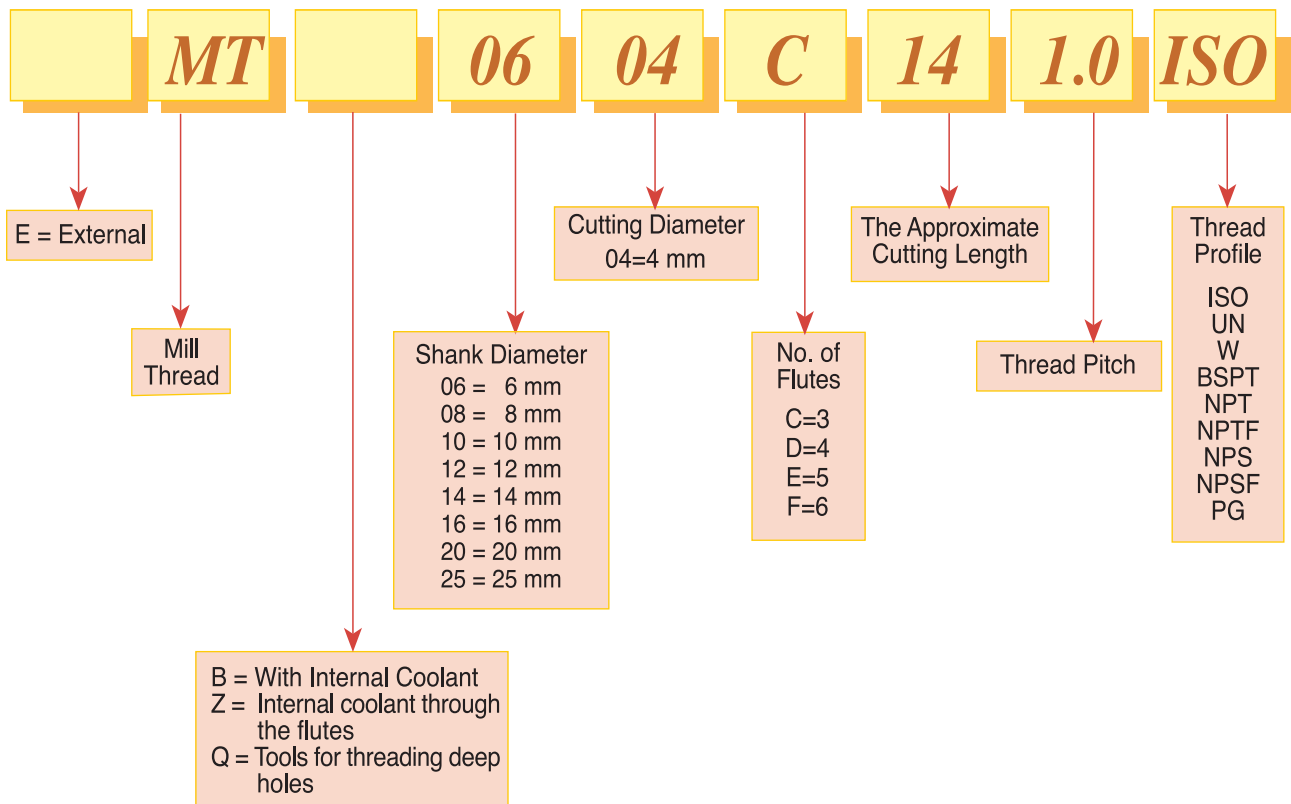

ISO

Tools for Internal Thread

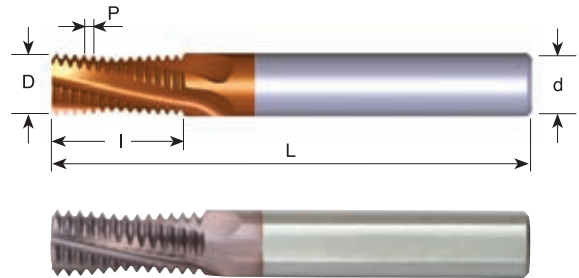
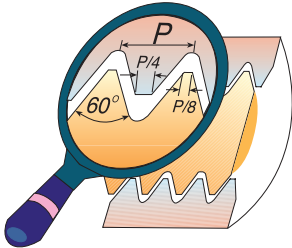

Pitch mm	M coarse	M fine	Ordering Code	d	D	No. of Flutes	I	L
0.5	M3	$\varnothing \geq 4$	MT06022C5 0.5 ISO	6	2.2	3	5.3	58
0.5		$\varnothing \geq 5$	MT06038C100.5 ISO	6	3.8	3	10.3	58
0.7	M4	$\varnothing \geq 5$	MT06031C7 0.7 ISO	6	3.1	3	7.4	58
0.75		$\varnothing \geq 6$	MT06045C100.75 ISO	6	4.5	3	10.1	58
0.8	M5	$\varnothing \geq 6$	MT06036C9 0.8 ISO	6	3.6	3	9.2	58
1.0	M6	$\varnothing \geq 7$	MT0604C10 1.0 ISO	6	4.0	3	10.5	58
1.0	M6	$\varnothing \geq 7$	MT0604C14 1.0 ISO	6	4.0	3	14.5	58
1.0		$\varnothing \geq 9$	MT0606C12 1.0 ISO	6	6.0	3	12.5	58
1.0		$\varnothing \geq 10$	MT0808D16 1.0 ISO	8	8.0	4	16.5	64
1.25	M8	$\varnothing \geq 10$	MT0605C14 1.25 ISO	6	5.0	3	14.4	58
1.25	M8	$\varnothing \geq 10$	MT0605C19 1.25 ISO	6	5.0	3	19.4	58
1.5	M10	$\varnothing \geq 12$	MT0807C17 1.5 ISO	8	7.0	3	17.3	64
1.5	M10	$\varnothing \geq 12$	MT0807C24 1.5 ISO	8	7.0	3	24.8	76
1.5		$\varnothing \geq 14$	MT1010D21 1.5 ISO	10	10.0	4	21.8	73
1.5		$\varnothing \geq 20$	MT1616F33 1.5 ISO	16	16.0	6	33.8	105
1.75	M12	$\varnothing \geq 14$	MT0808C20 1.75 ISO	8	8.0	3	20.1	64
1.75	M12	$\varnothing \geq 14$	MT0808C28 1.75 ISO	8	8.0	3	28.9	76
2.0	M16	$\varnothing \geq 17$	MT1010C27 2.0 ISO	10	10.0	3	27.0	73
2.0	M16	$\varnothing \geq 17$	MT1010C39 2.0 ISO	10	10.0	3	39.0	105
2.0		$\varnothing \geq 18$	MT1212D27 2.0 ISO	12	12.0	4	27.0	84
2.0		$\varnothing \geq 26$	MT2020F41 2.0 ISO	20	20.0	6	41.0	105
2.5	M20	$\varnothing \geq 22$	MT1414D33 2.5 ISO	14	14.0	4	33.8	84
2.5	M20	$\varnothing \geq 22$	MT1414D48 2.5 ISO	14	14.0	4	48.8	105
3.0	M24	$\varnothing \geq 25$	MT1616C40 3.0 ISO	16	16.0	3	40.5	105
3.0	M24	$\varnothing \geq 25$	MT1616C58 3.0 ISO	16	16.0	3	58.5	120
3.0	M27	$\varnothing \geq 28$	MT2020D43 3.0 ISO	20	20.0	4	43.5	105

Order example: MT 1212D27 2.0 ISO MT7

For thread mills with coolant bore see following pages

For small thread mills see pages 125 & 139



ISO With internal coolant bore

Tools for Internal Thread

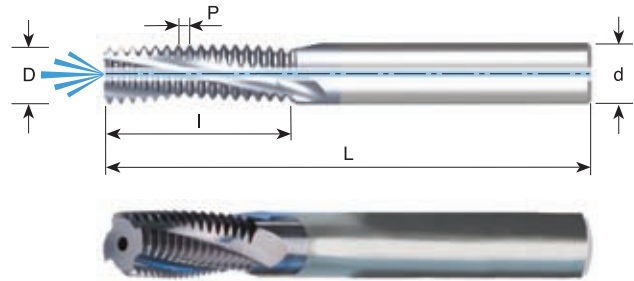
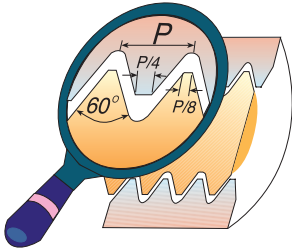

Pitch mm	M coarse	M fine	Ordering Code	d	D	No. of Flutes	I	L
0.5		$\varnothing \geq 5$	MTB06038C10 0.5 ISO	6	3.8	3	10.3	58
0.7	M 4	$\varnothing \geq 5$	MTB06031C7 0.7 ISO	6	3.1	3	7.4	58
0.75		$\varnothing \geq 6$	MTB06045C10 0.75 ISO	6	4.5	3	10.1	58
0.75		$\varnothing \geq 12$	MTB1010D24 0.75 ISO	10	10.0	4	24.4	73
0.8	M 5	$\varnothing \geq 6$	MTB06038C9 0.8 ISO	6	3.8	3	9.2	58
1.0	M 6	$\varnothing \geq 7$	MTB06046C10 1.0 ISO	6	4.6	3	10.5	58
1.0	M 6	$\varnothing \geq 7$	MTB06046C14 1.0 ISO	6	4.6	3	14.5	58
1.0		$\varnothing \geq 9$	MTB0606C12 1.0 ISO	6	6.0	3	12.5	58
1.0		$\varnothing \geq 10$	MTB0808D16 1.0 ISO	8	8.0	4	16.5	64
1.0		$\varnothing \geq 12$	MTB1010D24 1.0 ISO	10	10.0	4	24.5	73
1.25	M 8	$\varnothing \geq 10$	MTB0606C14 1.25 ISO	6	6.0	3	14.4	58
1.25	M 8	$\varnothing \geq 10$	MTB0606C19 1.25 ISO	6	6.0	3	19.4	58
1.5	M10	$\varnothing \geq 12$	MTB08078C17 1.5 ISO	8	7.8	3	17.0	64
1.5	M10	$\varnothing \geq 12$	MTB08078C24 1.5 ISO	8	7.8	3	24.8	76
1.5		$\varnothing \geq 14$	MTB1010D21 1.5 ISO	10	10.0	4	21.8	73
1.5		$\varnothing \geq 16$	MTB1212D26 1.5 ISO	12	12.0	4	26.3	84
1.5		$\varnothing \geq 20$	MTB1616F33 1.5 ISO	16	16.0	6	33.8	105
1.75	M12	$\varnothing \geq 12$	MTB1009C20 1.75 ISO	10	9.0	3	20.1	73
1.75	M12	$\varnothing \geq 12$	MTB1009C28 1.75 ISO	10	9.0	3	28.9	73
2.0	M14	$\varnothing \geq 15$	MTB1010C27 2.0 ISO	10	10.0	3	27.0	73
2.0	M16	$\varnothing \geq 17$	MTB12118D27 2.0 ISO	12	11.8	4	27.0	84
2.0	M16	$\varnothing \geq 17$	MTB12118D39 2.0 ISO	12	11.8	4	39.0	105
2.0		$\varnothing \geq 26$	MTB2020F41 2.0 ISO	20	20.0	6	41.0	105
2.5	M20	$\varnothing \geq 22$	MTB1615E33 2.5 ISO	16	15.0	5	33.8	105
2.5	M20	$\varnothing \geq 22$	MTB1615E48 2.5 ISO	16	15.0	5	48.8	105
3.0	M24	$\varnothing \geq 25$	MTB2018D40 3.0 ISO	20	18.0	4	40.5	105
3.0	M24	$\varnothing \geq 25$	MTB2018D58 3.0 ISO	20	18.0	4	58.5	120
3.0	M27	$\varnothing \geq 27$	MTB2020D43 3.0 ISO	20	20.0	4	43.5	105

Order example: MTB 08078C17 1.5 ISO MT7

For thread mills with coolant bore see following pages

For small thread mills see pages 125 & 139



ISO With internal coolant through the flutes Tools for Internal Thread

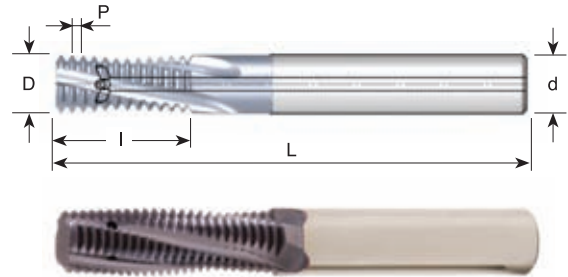
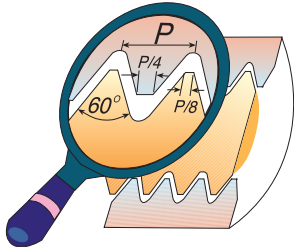

Pitch mm	M coarse	M fine	Ordering Code	d	D	No. of Flutes	I	L
1.0	M6	$\varnothing \geq 7$	MTZ06048C10 1.0 ISO	6	4.8	3	10.5	58
1.0		$\varnothing \geq 9$	MTZ0606C12 1.0 ISO	6	6.0	3	12.5	58
1.0		$\varnothing \geq 10$	MTZ0808D16 1.0 ISO	8	8.0	4	16.5	64
1.25	M8	$\varnothing \geq 10$	MTZ0606C14 1.25 ISO	6	6.0	3	14.4	58
1.25	M8	$\varnothing \geq 10$	MTZ0606C19 1.25 ISO	6	6.0	3	19.4	58
1.5	M10	$\varnothing \geq 12$	MTZ08078C17 1.5 ISO	8	7.8	3	17.0	64
1.5		$\varnothing \geq 14$	MTZ1010D21 1.5 ISO	10	10.0	4	21.8	73
1.5		$\varnothing \geq 16$	MTZ1212D26 1.5 ISO	12	12.0	4	26.3	84
1.5		$\varnothing \geq 20$	MTZ1616E33 1.5 ISO	16	16.0	5	33.8	101
1.75	M12	$\varnothing \geq 12$	MTZ1009C20 1.75 ISO	10	9.0	3	20.1	73
1.75	M12	$\varnothing \geq 12$	MTZ1009C28 1.75 ISO	10	9.0	3	28.9	73
2.0	M14	$\varnothing \geq 15$	MTZ1010C27 2.0 ISO	10	10.0	3	27.0	73
2.0	M16	$\varnothing \geq 17$	MTZ12118D27 2.0 ISO	12	11.8	4	27.0	84
2.5	M20	$\varnothing \geq 22$	MTZ1615E33 2.5 ISO	16	15.0	5	33.8	101

Order example: MTZ 08078C17 1.5 ISO MT7



ISO With relieved neck and internal coolant bore

Tools for Internal Thread

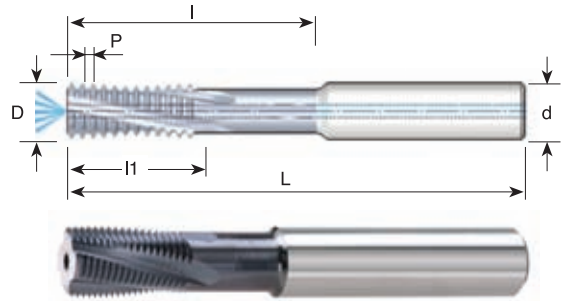
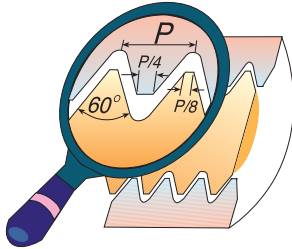

Pitch TPI	M fine	Ordering Code	d	D	No. of Flutes	l1	l	L
1.0	∅ ≥ 12	MTQ1010D32 1.0 ISO	10	10.0	4	18.0	32.0	73
1.0	∅ ≥ 14	MTQ1212D38 1.0 ISO	12	12.0	4	21.0	38.0	84
1.0	∅ ≥ 18	MTQ1616F45 1.0 ISO	16	16.0	6	26.0	45.0	105
1.5	∅ ≥ 13	MTQ1010D30 1.5 ISO	10	10.0	4	18.0	30.0	73
1.5	∅ ≥ 15	MTQ1212D34 1.5 ISO	12	12.0	4	19.5	34.5	84
1.5	∅ ≥ 19	MTQ1616F43 1.5 ISO	16	16.0	6	25.5	43.5	105
1.5	∅ ≥ 23	MTQ2020F60 1.5 ISO	20	20.0	6	36.0	60.0	105
2.0	∅ ≥ 16	MTQ1212D42 2.0 ISO	12	12.0	4	24.0	42.0	84
2.0	∅ ≥ 20	MTQ1616E45 2.0 ISO	16	16.0	5	26.0	45.0	105
2.0	∅ ≥ 24	MTQ2020F56 2.0 ISO	20	20.0	6	34.0	56.0	105
3.0	∅ ≥ 22	MTQ1616D45 3.0 ISO	16	16.0	4	30.0	45.0	105
3.0	∅ ≥ 26	MTQ2020E54 3.0 ISO	20	20.0	5	33.0	54.0	105
3.5	∅ ≥ 26	MTQ2020D45 3.5 ISO	20	20.0	4	28.0	45.5	105
4.0	∅ ≥ 31	MTQ2525D64 4.0 ISO	25	25.0	4	40.0	64.0	160

Order example: MTQ 1010D30 1.5 ISO MT7

Thread mills with relieved neck and internal coolant for milling medium and large threads on relatively deep work pieces.

Carbide grade: MT7

- To perform medium and large threads on relatively deep work pieces.
- To use overhang according to the application.
- To perform deep threads at the bottom of the application.

Advantages

- Provides high rigidity and stability (anti-vibrations).
- Accomplishes deep threads in one pass.
- Relatively low cutting forces due to short cutting length which enables reduction of the radial in feed required.
- Threads length up to 3D.

For small thread mills see pages 125 & 139



G 55° BSF, BSP

Same Tool for Internal and External Thread

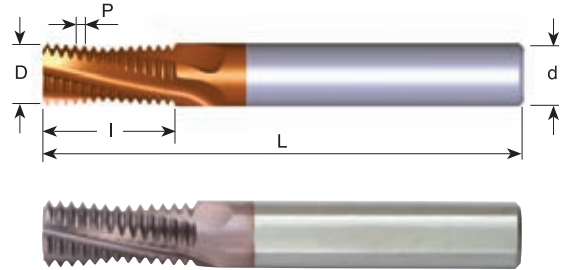
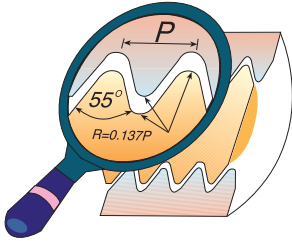

Pitch TPI	Standard	Ordering Code	d	D	No. of Flutes	I	L
28	G1/8	MT0606C9 28W	6	6.0	3	9.5	58
19	G1/4-3/8	MT0808C14 19W	8	8.0	3	14.0	64
14	G1/2-7/8	MT1212D19 14W	12	12.0	4	19.0	84
14	G1/2-7/8	MT1212D26 14W	12	12.0	4	26.3	84
11	G1-1 1/2	MT1212C24 11W	12	12.0	3	24.2	84
11	G1-3	MT1616D38 11W	16	16.0	4	38.1	105
11	G≥1	MT2020E47 11W	20	20.0	5	47.3	105

Order example: MT 1212D19 14 W MT7

With internal coolant bore

Same Tool for Internal and External Thread

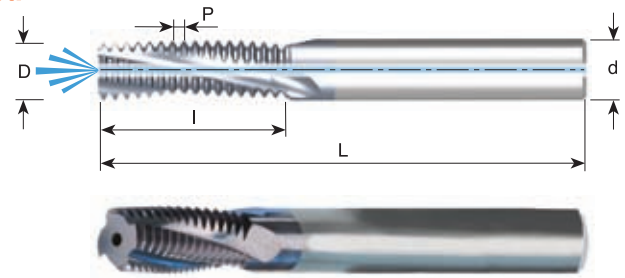

Pitch TPI	Standard	Ordering Code	d	D	No. of Flutes	I	L
28	G1/8	MTB08078C14 28W	8	7.8	3	14.1	64
19	G1/4-3/8	MTB1010D16 19W	10	10.0	4	16.7	73
14	G1/2-7/8	MTB1616E26 14W	16	16.0	5	26.3	105
11	G≥1	MTB1616D38 11W	16	16.0	4	38.1	105
11	G≥1	MTB2020E47 11W	20	20.0	5	47.3	105

Order example: MTB 1010D16 19 W MT7

For thread mills with coolant bore see following pages

For small thread mills with coolant through the flutes see page 127

G 55° BSF, BSP With internal coolant through the flutes

Same Tool for Internal and External Thread

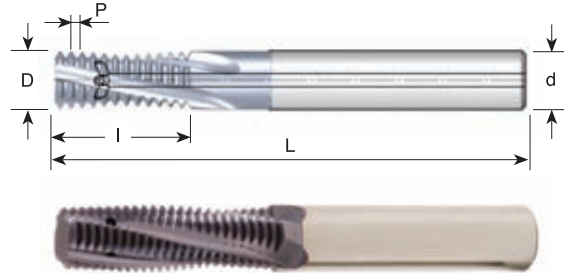
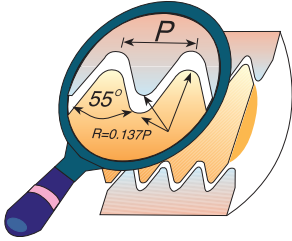

Pitch TPI	Standard	Ordering Code	d	D	No. of Flutes	I	L
28	G1/8	MTZ08078C14 28W	8	7.8	3	14.1	64
19	G1/4-3/8	MTZ1010D16 19W	10	10.0	4	16.7	73
14	G1/2-7/8	MTZ1616E26 14W	16	16.0	5	26.3	101
11	G≥1	MTZ1616D38 11W	16	16.0	4	38.1	101

Order example: MTZ 08078C14 28W MT7

For small thread mills with coolant through the flutes see page 127

Whitworth BSW With internal coolant through the flutes

Same Tool for Internal and External Thread

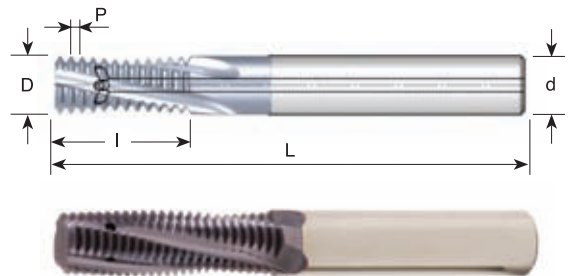
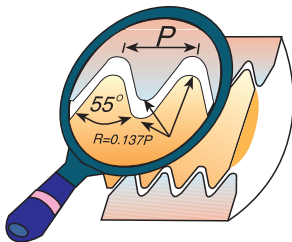

Pitch TPI	Standard	Ordering Code	d	D	No. of Flutes	I	L
*20	1/4	MTZ06046C12 20W	6	4.6	3	12.1	58
18	5/16	MTZ06053C14 18W	6	5.3	3	14.8	58
16	3/8	MTZ08068C16 16W	8	6.8	3	16.7	64
16	1/2	MTZ10092D24 16W	10	9.2	4	24.6	73
14	7/16	MTZ08078D20 14W	8	7.8	4	20.9	64
12	1/2	MTZ10086D24 12W	10	8.6	4	24.4	73
11	5/8	MTZ12109D28 11W	12	10.9	4	28.9	84

Order example: MTZ 08068C16 16W MT7

* Cutter without coolant

UN

Tools for Internal Thread

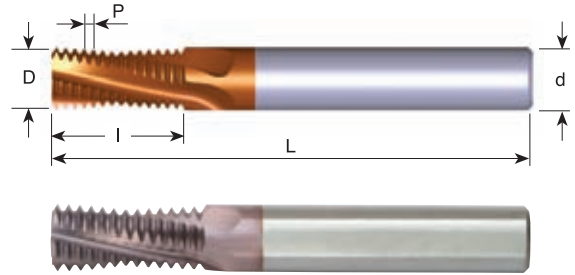
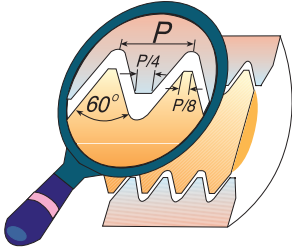

Pitch TPI	UNC	UNF	UNEF	Ordering Code	d	D	No. of Flutes	I	L
40	5			MT06025C6 40 UN	6	2.5	3	6.0	58
32	8	10	12	MT06032C6 32 UN	6	3.2	3	6.8	58
28		1/4		MT0604C11 28 UN	6	4.0	3	11.3	58
28			7/16-1/2	MT0606C14 28 UN	6	6.0	3	14.1	58
24		5/16		MT0605C14 24 UN	6	5.0	3	14.3	58
24		3/8	9/16-5/8	MT0807C21 24 UN	8	7.0	3	20.6	64
20	1/4			MT06045C12 20 UN	6	4.5	3	12.1	58
20		7/16-1/2		MT0807C21 20 UN	8	7.0	3	21.0	64
20			3/4-1	MT1212E27 20 UN	12	12.0	5	27.3	84
18	5/16			MT0605C14 18 UN	6	5.0	3	14.8	58
18		9/16-5/8	1 1/8 - 1 5/8	MT1010D26 18 UN	10	10.0	4	26.1	73
16	3/8			MT0606C16 16 UN	6	6.0	3	16.7	58
16		3/4		MT1212D31 16 UN	12	12.0	4	31.0	84
14	7/16			MT0807C20 14 UN	8	7.0	3	20.9	64
14		7/8		MT1615E37 14 UN	16	15.0	5	37.2	105
13	1/2			MT0808C22 13 UN	8	8.0	3	22.5	64
12	9/16			MT1010C26 12 UN	10	10.0	3	26.5	73
12		1 - 1 1/2		MT1616E41 12 UN	16	16.0	5	41.3	105
11	5/8			MT1010C28 11 UN	10	10.0	3	28.9	73
10	3/4			MT1212C34 10 UN	12	12.0	3	34.3	84
9	7/8			MT1615C38 9 UN	16	15.0	3	38.1	105
8	1			MT1616C42 8 UN	16	16.0	3	42.9	105
7	1 1/8 - 1 1/4			MT2020D45 7 UN	20	20.0	4	45.3	105

Order example: MT 1615E37 14UN MT7

For thread mills with coolant bore see following pages

For small thread mills see pages 126-127 & 140



UN With internal coolant bore

Tools for Internal Thread

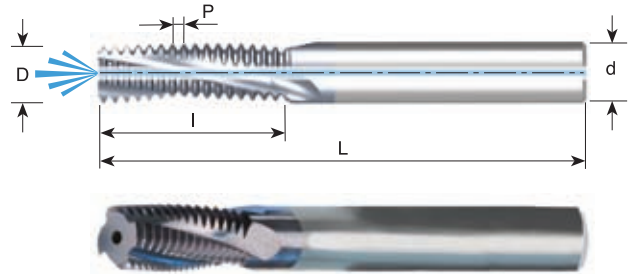
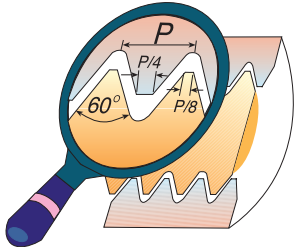

Pitch TPI	UNC	UNF	UNEF	Ordering Code	d	D	No. of Flutes	I	L
32	8	10	12	MTB06032C6 32 UN	6	3.2	3	6.8	58
32			5/16	MTB0606C14 32 UN	6	6.0	3	14.7	58
32			3/8	MTB0808D18 32 UN	8	8.0	4	18.7	64
28		1/4		MTB0605C11 28 UN	6	5.0	3	11.3	58
28			7/16-1/2	MTB0606C14 28 UN	6	6.0	3	14.1	58
24		5/16		MTB08066C14 24 UN	8	6.6	3	14.3	64
24		3/8	9/16-5/8	MTB0808D21 24 UN	8	8.0	4	20.6	64
20	1/4			MTB06047C12 20 UN	6	4.7	3	12.1	58
20		7/16		MTB0808C21 20 UN	8	8.0	3	21.0	64
20		1/2		MTB1010D22 20 UN	10	10.0	4	22.3	73
20			3/4-1	MTB1212E27 20 UN	12	12.0	5	27.3	84
18	5/16			MTB06056C14 18 UN	6	5.6	3	14.8	58
18		9/16-5/8	1 1/8-1 5/8	MTB12113D26 18 UN	12	11.3	4	26.1	84
16	3/8			MTB08067C16 16 UN	8	6.7	3	16.7	64
16		3/4		MTB1212D31 16 UN	12	12.0	4	31.0	84
14	7/16			MTB08077C20 14 UN	8	7.7	3	20.9	64
14		7/8		MTB1616E37 14 UN	16	16.0	5	37.2	105
13	1/2			MTB10092C22 13 UN	10	9.2	3	22.5	73
12	9/16			MTB12105C26 12 UN	12	10.5	3	26.5	84
12		1-1 1/2		MTB1616E41 12 UN	16	16.0	5	41.3	105
11	5/8			MTB12114C28 11 UN	12	11.4	3	28.9	84
10	3/4			MTB16144D34 10 UN	16	14.4	4	34.3	105
9	7/8			MTB1616C38 9 UN	16	16.0	3	38.1	105
8	1			MTB20195D42 8 UN	20	19.5	4	42.9	105
7	1 1/8-1 1/4			MTB2020D45 7 UN	20	20.0	4	45.3	105

Order example: [MTB 1212D31 16 UN MT7](#)

For thread mills with coolant bore see following pages

For small thread mills see pages 126-127 & 140



UN With internal coolant through the flutes

Tools for Internal Thread

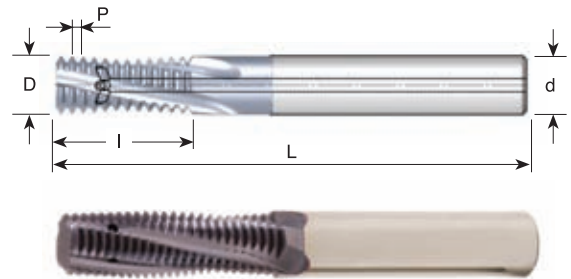
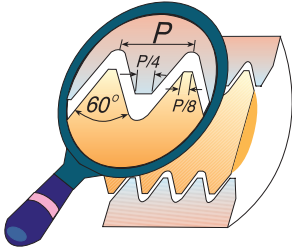

Pitch TPI	UNC	UNF	UNEF	Ordering Code	d	D	No. of Flutes	I	L
28		1/4		MTZ0605C11 28 UN	6	5.0	3	11.3	58
28			7/16-1/2	MTZ0606C14 28 UN	6	6.0	3	14.1	58
24		5/16		MTZ08066C14 24 UN	8	6.6	3	14.3	64
24		3/8	9/16-5/8	MTZ0808D21 24 UN	8	8.0	4	20.6	64
20		7/16		MTZ0808C21 20 UN	8	8.0	3	21.0	64
20		1/2		MTZ1010D22 20 UN	10	10.0	4	22.3	73
20			3/4-1	MTZ1212E27 20 UN	12	12.0	5	27.3	84
18	5/16			MTZ06056C14 18 UN	6	5.6	3	14.8	58
18		9/16-5/8	1 1/8-1 5/8	MTZ12113D26 18 UN	12	11.3	4	26.1	84
16	3/8			MTZ08067C16 16 UN	8	6.7	3	16.7	64
16		3/4		MTZ1212D31 16 UN	12	12.0	4	31.0	84
14	7/16			MTZ08077C20 14 UN	8	7.7	3	20.9	64
14		7/8		MTZ1616E37 14 UN	16	16.0	5	37.2	101
13	1/2			MTZ10092C22 13 UN	10	9.2	3	22.5	73
12	9/16			MTZ12105C26 12 UN	12	10.5	3	26.5	84
11	5/8			MTZ12114C28 11 UN	12	11.4	3	28.9	84
10	3/4			MTZ16144D34 10 UN	16	14.4	4	34.3	101

Order example: MTZ 0808D21 24UN MT7



UN With relieved neck and internal coolant bore

Tools for Internal Thread

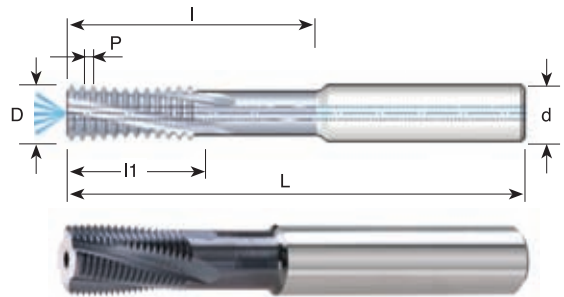
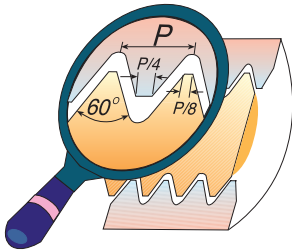

Pitch TPI	M fine	Ordering Code	d	D	No. of Flutes	l1	l	L
20	$\varnothing \geq 12$	MTQ1010D30 20 UN	10	10.0	4	17.8	30.5	73
20	$\varnothing \geq 14$	MTQ1212E35 20 UN	12	12.0	5	20.3	35.6	84
20	$\varnothing \geq 18$	MTQ1616F43 20 UN	16	16.0	6	25.4	43.2	105
18	$\varnothing \geq 15$	MTQ1212D35 18 UN	12	12.0	4	19.7	35.3	84
16	$\varnothing \geq 15$	MTQ1212D35 16 UN	12	12.0	4	20.7	35.0	84
16	$\varnothing \geq 19$	MTQ1616E42 16 UN	16	16.0	5	25.4	42.9	105
16	$\varnothing \geq 23$	MTQ2020F58 16 UN	20	20.0	6	36.5	58.8	105
14	$\varnothing \geq 20$	MTQ1616E45 14 UN	16	16.0	5	25.4	45.3	105
12	$\varnothing \geq 16$	MTQ1212D42 12 UN	12	12.0	4	25.4	42.3	84
12	$\varnothing \geq 24$	MTQ2020E55 12 UN	20	20.0	5	33.9	55.1	105

Order example: MTQ 1212D35 16 UN MT7

Thread mills with relieved neck and internal coolant for milling medium and large threads on relatively deep work pieces.

Carbide grade: MT7

- To perform medium and large threads on relatively deep work pieces.
- To use overhang according to the application.
- To perform deep threads at the bottom of the application.

Advantages

- Provides high rigidity and stability (anti-vibrations).
- Accomplishes deep threads in one pass.
- Relatively low cutting forces due to short cutting length which enables reduction of the radial in feed required.
- Threads length up to 3D.

For small thread mills see pages 126-127 & 140



BSPT

Same Tool for Internal and External Thread

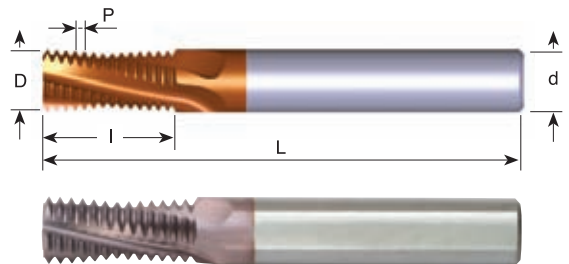
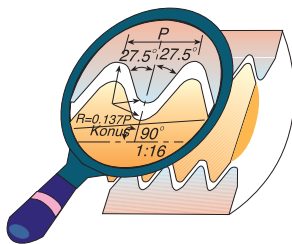

Pitch TPI	Standard	Ordering Code	d	D	No. of Flutes	l	L
28	RC1/8	MT0606C9 28 BSPT	6	6.0	3	9.5	58
19	RC1/4-3/8	MT0808C14 19 BSPT	8	8.0	3	14.0	64
14	RC1/2-7/8	MT1212D19 14 BSPT	12	12.0	4	19.1	84
11	RC1-2	MT1616D28 11 BSPT	16	16.0	4	28.9	105

Order example: MT 1616D28 11 BSPT MT7

For thread mills with coolant through the flutes see next page

BSPT With internal coolant bore

Same Tool for Internal and External Thread

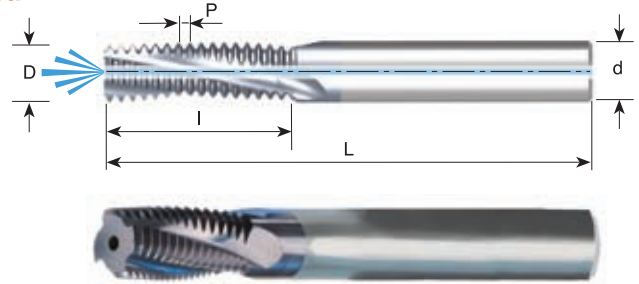
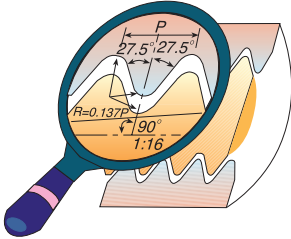

Pitch TPI	Standard	Ordering Code	d	D	No. of Flutes	I	L
28	RC1/8	MTB08078C14 28 BSPT	8	7.8	3	14.1	64
19	RC1/4-3/8	MTB1010D16 19 BSPT	10	10.0	4	16.7	73
14	RC1/2-7/8	MTB1616E26 14 BSPT	16	16.0	5	26.3	105
11	RC1-2	MTB1616D28 11 BSPT	16	16.0	4	28.9	105

Order example: MTB 0807C14 28 BSPT MT7

BSPT With internal coolant through the flutes

Same Tool for Internal and External Thread

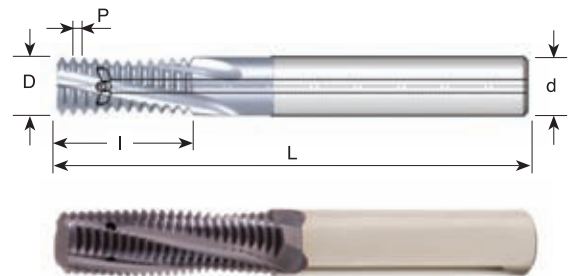
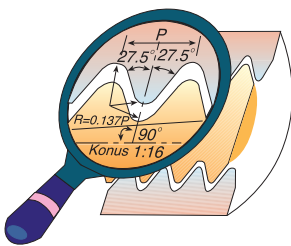

Pitch TPI	Standard	Ordering Code	d	D	No. of Flutes	I	L
28	RC1/8	MTZ08078C14 28 BSPT	8	7.8	3	14.1	64
19	RC1/4-3/8	MTZ1010D16 19 BSPT	10	10.0	4	16.7	73
14	RC1/2-7/8	MTZ1616E26 14 BSPT	16	16.0	5	26.3	101
11	RC1-2	MTZ1616D28 11 BSPT	16	16.0	4	28.9	101

Order example: MTZ 1010D16 19 BSPT MT7

NPT

Same Tool for Internal and External Thread

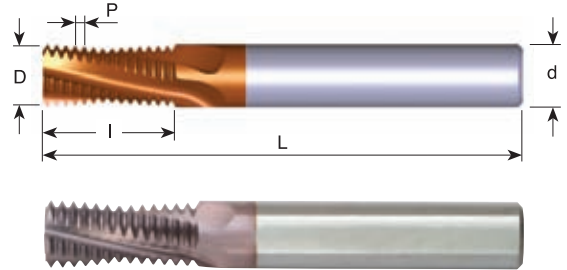
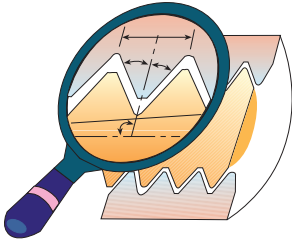

Pitch TPI	Standard	Ordering Code	d	D	No. of Flutes	I	L
27	1/16-1/8	MT0606C9 27 NPT	6	6.0	3	9.9	58
18	1/4-3/8	MT0808C14 18 NPT	8	8.0	3	14.8	64
14	1/2-3/4	MT1212D20 14 NPT	12	12.0	4	20.9	84
11.5	1-2	MT1616D27 11.5 NPT	16	16.0	4	27.6	105
8	≥ 2 1/2	MT2020D39 8 NPT	20	20.0	4	39.7	105

Order example: MT 0808C14 18 NPT MT7

NPT With internal coolant bore

Same Tool for Internal and External Thread

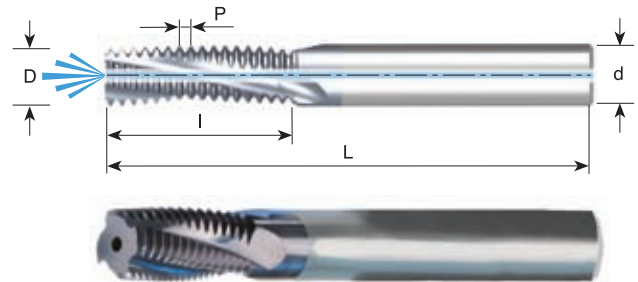

Pitch TPI	Standard	Ordering Code	d	D	No. of Flutes	I	L
27	1/8	MTB08076C10 27 NPT	8	7.6	3	10.8	64
18	1/4-3/8	MTB1010D16 18 NPT	10	10.0	4	16.2	73
14	1/2-3/4	MTB16155D22 14 NPT	16	15.5	4	22.7	105
11.5	1-2	MTB2020D29 11.5 NPT	20	20.0	4	29.8	105
8	≥ 2 1/2	MTB2020D39 8 NPT	20	20.0	4	39.7	105

Order example: MTB 1010D16 18 NPT MT7

For thread mills with coolant bore see following pages

For conical preparation end mills see page 121

NPT With internal coolant through the flutes

Same Tool for Internal and External Thread

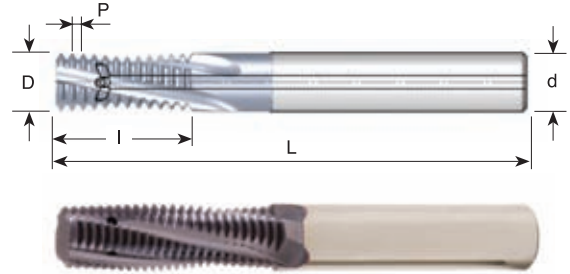
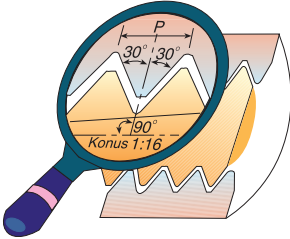

Pitch TPI	Standard	Ordering Code	d	D	No. of Flutes	I	L
27	1/8	MTZ08076C10 27NPT	8	7.6	3	10.8	64
18	1/4-3/8	MTZ1010D16 18NPT	10	10.0	4	16.2	73
14	1/2-3/4	MTZ16155D22 14NPT	16	15.5	4	22.7	101

Order example: MTZ 08076C10 27 NPT MT7

NPTF

Same Tool for Internal and External Thread

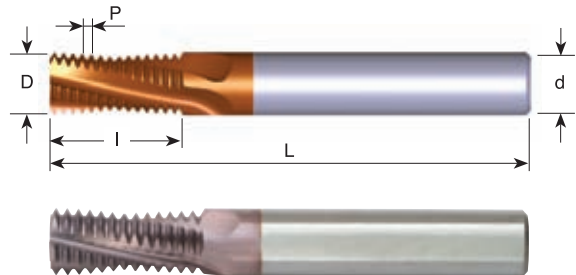
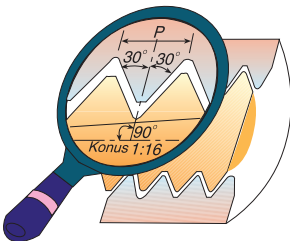

Pitch TPI	Standard	Ordering Code	d	D	No. of Flutes	I	L
27	1/16-1/8	MT0606C9 27 NPTF	6	6.0	3	9.9	58
18	1/4-3/8	MT0808C14 18 NPTF	8	8.0	3	14.8	64
14	1/2-3/4	MT1212D20 14 NPTF	12	12.0	4	20.9	84
11.5	1-2	MT1616D27 11.5 NPTF	16	16.0	4	27.6	105
8	≥ 2 1/2	MT2020D39 8 NPTF	20	20.0	4	39.7	105

Order example: MT 1212D20 14 NPTF MT7

For thread mills with coolant bore see following pages

For conical preparation end mills see page 121

NPTF With internal coolant bore

Same Tool for Internal and External Thread

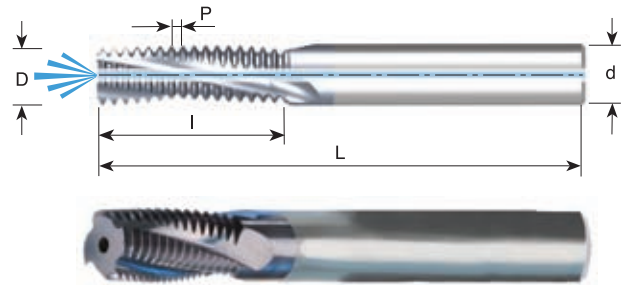
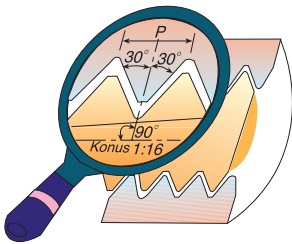

Pitch TPI	Standard	Ordering Code	d	D	No. of Flutes	I	L
27	1/8	MTB08076C10 27 NPTF	8	7.6	3	10.8	64
18	1/4-3/8	MTB1010D16 18 NPTF	10	10.0	4	16.2	73
14	1/2-3/4	MTB16155D22 14 NPTF	16	15.5	4	22.7	105
11.5	1-2	MTB2020D29 11.5 NPTF	20	20.0	4	29.8	105
8	≥ 2 1/2	MTB2020D39 8 NPTF	20	20.0	4	39.7	105

Order example: MTB 16155D22 14 NPTF MT7

NPTF With internal coolant through the flutes

Same Tool for Internal and External Thread

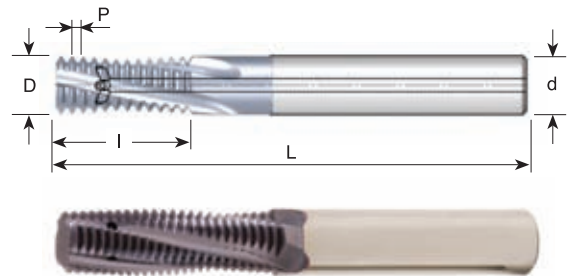
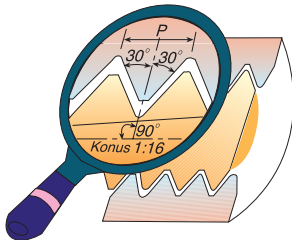

Pitch TPI	Standard	Ordering Code	d	D	No. of Flutes	I	L
27	1/8	MTZ08076C10 27NPTF	8	7.6	3	10.8	64
18	1/4-3/8	MTZ1010D16 18NPTF	10	10.0	4	16.2	73
14	1/2-3/4	MTZ16155D22 14NPTF	16	15.5	4	22.7	101

Order example: MTZ 1010D16 18 NPTF MT7

NPS With internal coolant bore

Same Tool for Internal and External Thread - Inch Shank

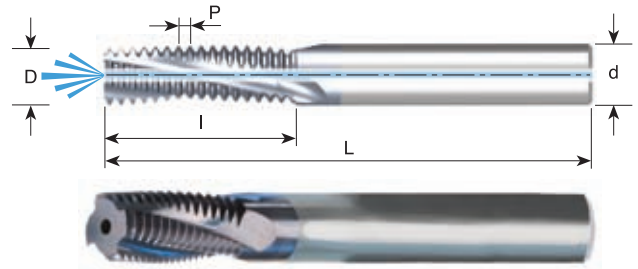
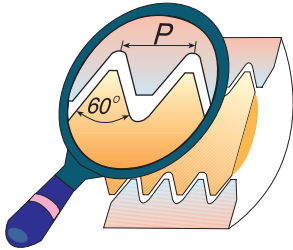

Pitch TPI	Standard	Ordering Code	d inch	D	No. of Flutes	I	L
27	1/8	MTB0312C04 27 NPS	5/16	7.6	3	10.8	63
18	1/4-3/8	MTB0375D06 18 NPS	3/8	9.5	4	16.2	76
14	1/2-3/4	MTB0625D08 14 NPS	5/8	15.5	4	22.7	101
11.5	1-2	MTB0750D11 11.5 NPS	3/4	19.0	4	29.8	101

Order example: MTB 0375D06 18 NPS MT7

NPSF With internal coolant bore

Same Tool for Internal and External Thread - Inch Shank

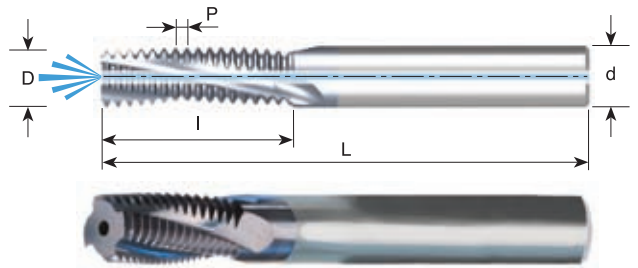

Pitch TPI	Standard	Ordering Code	d inch	D	No. of Flutes	I	L
27	1/8	MTB0312C04 27 NPSF	5/16	7.6	3	10.8	63
18	1/4-3/8	MTB0375D06 18 NPSF	3/8	9.5	4	16.2	76
14	1/2-3/4	MTB0625D08 14 NPSF	5/8	15.5	4	22.7	101
11.5	1-2	MTB0750D11 11.5 NPSF	3/4	19.0	4	29.8	101

Order example: MTB 0312C04 27 NPSF MT7

PG DIN 40430 - With internal coolant bore

Same Tool for Internal and External Thread

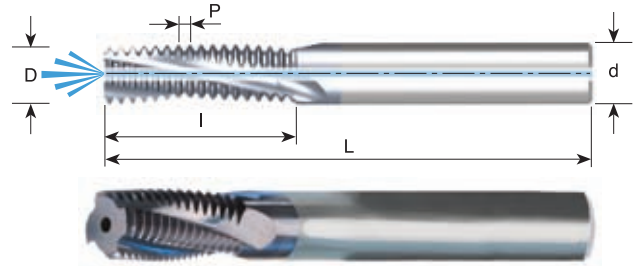
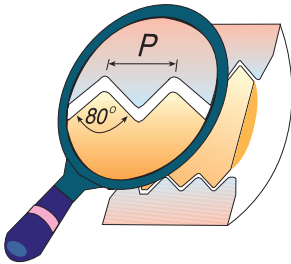

Pitch TPI	Standard	Ordering Code	d	D	No. of Flutes	I	L
20	Pg 7	MTB1010D19 20PG	10	10.0	4	19.7	73
18	Pg 9, 11, 13.5, 16	MTB1212D20 18PG	12	12.0	4	20.5	84
16	Pg 21, 29, 36, 42, 48	MTB1212D23 16PG	12	12.0	4	23.0	84

Order example: MTB 1212 D20 18 PG MT7

Solid Carbide Tapered End Mills

Solid carbide tapered end mills are used for milling preparation of conic threads before the thread milling operation.

Advantages:

- * Increases the tool life of mill thread cutters and indexable inserts.
- * Equal and uniform load along the cutting edge of the mill thread cutter.
- * Shorter machining time during the mill thread operation, due to the tapered preparation.

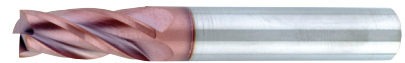
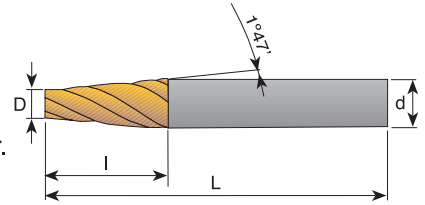

Ordering Code	d	D	I	L	No. of Flutes	Size
SC0652D12	6	5.2	12	58	4	NPT 1/16" - 1/8" NPTF 1/16" - 1/8" BSPT 1/16" - 1/8"
SC1085D24	10	8.5	24	73	4	NPT 1/8" - 1" NPTF 1/8" - 1" BSPT 1/8" - 1"
SC1210D32	12	10	32	84	4	NPT 1/4" - 3" NPTF 1/4" - 3" BSPT 1/4" - 3"

Carbide grade: MT7

Order example: SC1085D24 MT7

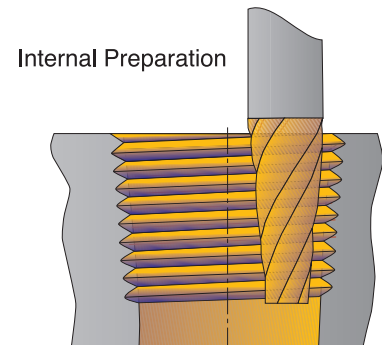
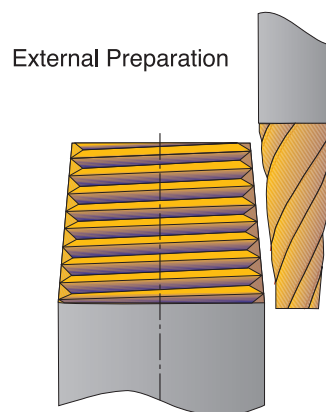

Mill - Thread Solid Carbide for External Threads

Advantages:

- * Excellent surface finish thanks to the spiral flutes
- * Short machining time due to multi 3 to 5 flutes

ISO

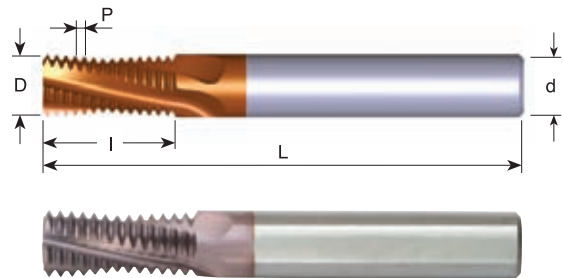
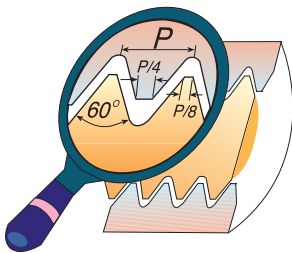

Pitch mm	Ordering Code	d	D	No. of Flutes	I	L
1.0	EMT1010D16 1.0 ISO	10	10.0	4	16.5	73
1.0	EMT1212E20 1.0 ISO	12	12.0	5	20.5	84
1.25	EMT1010D16 1.25 ISO	10	10.0	4	16.9	73
1.5	EMT1010D15 1.5 ISO	10	10.0	4	15.8	73
1.5	EMT1212D20 1.5 ISO	12	12.0	4	20.3	84
1.75	EMT1212D20 1.75 ISO	12	12.0	4	20.1	84
2.0	EMT1010C17 2.0 ISO	10	10.0	3	17.0	73
2.0	EMT1212D21 2.0 ISO	12	12.0	4	21.0	84

Order example: EMT 1010D15 1.5 ISO MT7

UN

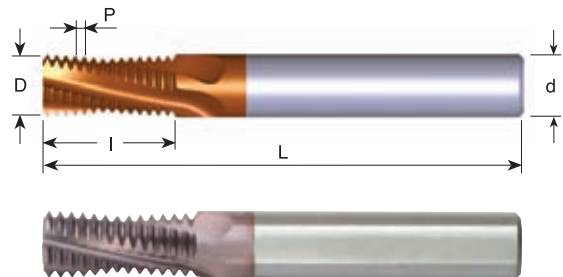
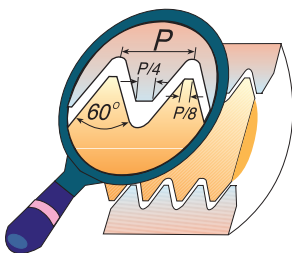

Pitch TPI	Ordering Code	d	D	No. of Flutes	I	L
24	EMT1010D16 24 UN	10	10.0	4	16.4	73
20	EMT1212E21 20 UN	12	12.0	5	21.0	84
18	EMT1212D20 18 UN	12	12.0	4	20.5	84
16	EMT1212D21 16 UN	12	12.0	4	21.4	84
14	EMT1212D20 14 UN	12	12.0	4	20.9	84
12	EMT1212D20 12 UN	12	12.0	4	20.1	84

Order example: EMT 1212D20 18 UN MT7

Mini Mill-Thread



MTS

- Threading from M1 x 0.25.
- Working in high cutting speed.
- Short machining time.
- Low cutting forces thanks to the short profile.
- No broken taps.
- Machining of hardened materials up to 45 HRc.

Carbide grade: MT7

Sub-Micron grade with Titanium Aluminum Nitride multi-layer coating (ISO K10 - K20). To be run at medium to high cutting speeds. General purpose for all materials.

MTI For threading deep parts

Carbide grade: MT8 Sub-micron grade with advanced PVD triple coating (ISO K10-K20). Extremely high heat resistant and smooth cutting operation, for high performance, and normal machining conditions. General purpose for all materials.

MT11 Ultra-fine sub-micron grade with advanced PVD triple blue coating.

Advantages:

- Enables machining in deep holes.
- Same tool can produce a wide range of threads and pitches.
- Same tool can produce both External and Internal threads.
- Coolant through the flutes is very effective for deep holes.
- Spiral flutes allow smooth cutting action.
- Shorter machining time due to multi, 3 to 5, flutes.
- Longer tool life due to special triple coating.

Contents:

Page:

Contents:

Page:

Product Identification	124
MTS	
ISO	125
UN	126-127
G55°	127
UNJ - with Internal Coolant through the flutes	128
MJ - with Internal Coolant through the flutes	128

MTI	
Partial Profile 60°	129
Partial Profile 60° - with Internal Coolant through the flutes	129
Partial Profile 55°	130
ISO	131
UN	131

Product Identification

Mini Mill-Thread MTS Ordering Codes

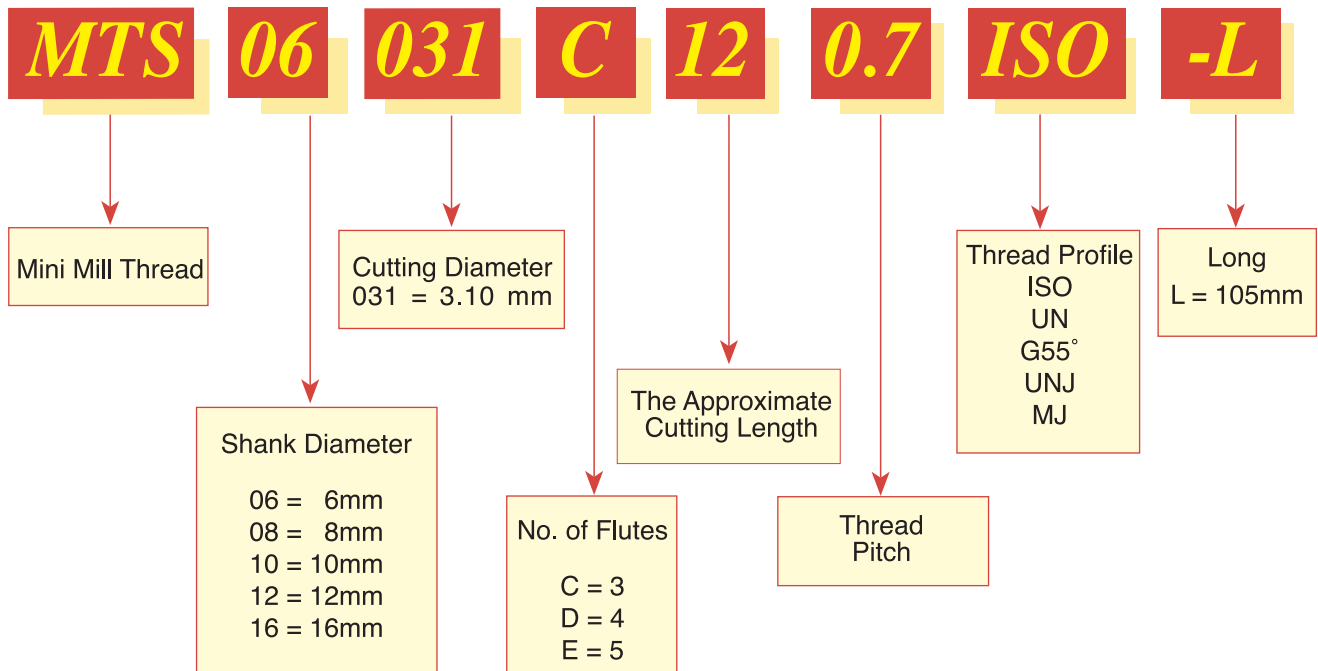

Mini Mill-Thread MTI Ordering Codes

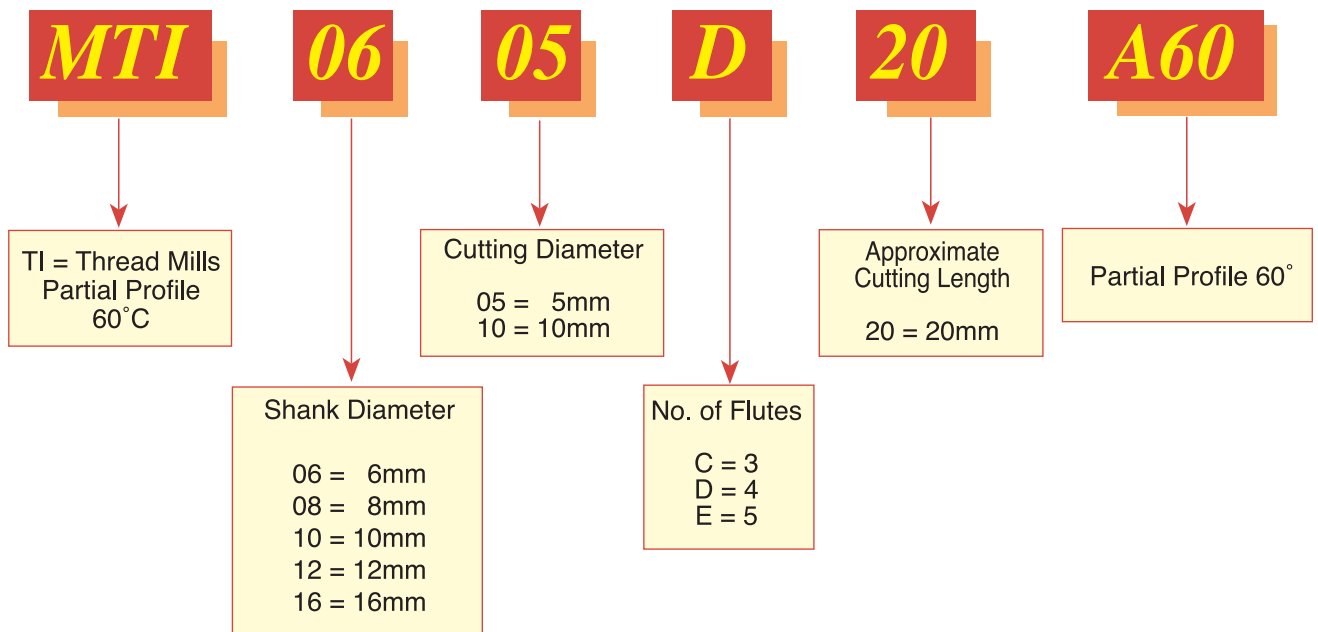

ISO

Tools for Internal Thread

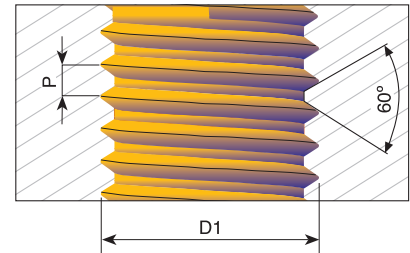
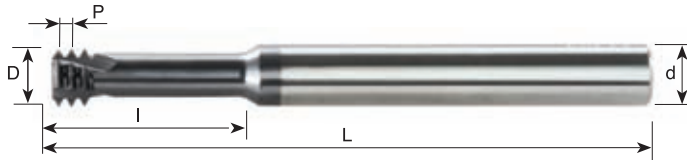

For thread depth up to 2 x D1

Pitch mm	D1	Ordering Code	d	D	No. of Flutes	I	L
0.25	M1	MTS03007C2 0.25 ISO	3	0.72	3	2.5	39
0.25	M1.2	MTS03009C3 0.25 ISO	3	0.90	3	3.0	39
0.4	M2	MTS06016C4 0.4 ISO	6	1.53	3	4.5	58
0.4	M2	MTS06016C4 0.4 ISO-L	6	1.53	3	4.5	105
0.45	M2.2	MTS06017C5 0.45 ISO	6	1.65	3	5.0	58
0.45	M2.5	MTS0602C5 0.45 ISO	6	1.95	3	5.5	58
0.45	M2.5	MTS0602C5 0.45 ISO-L	6	1.95	3	5.5	105
0.5	M3	MTS06024C6 0.5 ISO	6	2.37	3	6.5	58
0.5	M3	MTS06024C6 0.5 ISO-L	6	2.37	3	6.5	105
0.6	M3.5	MTS06028C7 0.6 ISO	6	2.75	3	7.5	58
0.7	M4	MTS06031C9 0.7 ISO	6	3.10	3	9.0	58
0.75	M10	MTS0808D25 0.75 ISO	8	8.00	4	25.0	64
0.8	M5	MTS06038C12 0.8 ISO	6	3.80	3	12.5	58
1.0	M6	MTS06047C14 1.0 ISO	6	4.65	3	14.0	58
1.25	M8	MTS0606C18 1.25 ISO	6	6.00	3	18.0	58
1.5	M10	MTS08078C23 1.5 ISO	8	7.80	3	23.0	64
1.75	M12	MTS1009C26 1.75 ISO	10	9.00	3	26.0	73
2.0	M16	MTS12118D35 2.0 ISO	12	11.80	4	35.0	84
2.5	M20	MTS1615E43 2.5 ISO	16	15.00	5	43.0	105

For thread depth up to 3 x D1

Pitch mm	D1	Ordering Code	d	D	No. of Flutes	I	L
* 0.3	M1.4	MTS03011C4 0.3 ISO	3	1.05	3	4.0	39
* 0.35	M1.6	MTS03012C5 0.35 ISO	3	1.20	3	4.8	39
* 0.4	M2	MTS03016C6 0.4 ISO	3	1.53	3	6.0	39
0.45	M2.5	MTS0602C7 0.45 ISO	6	1.95	3	7.5	58
0.5	M3	MTS06024C9 0.5 ISO	6	2.37	3	9.5	58
0.5	M3	MTS06024C9 0.5 ISO-L	6	2.37	3	9.5	105
0.5	M6, M7	MTS06054D20 0.5 ISO	6	5.35	4	20.0	58
0.6	M3.5	MTS06028C10 0.6 ISO	6	2.75	3	10.5	58
0.7	M4	MTS06031C12 0.7 ISO	6	3.10	3	12.5	58
0.7	M4	MTS06031C12 0.7 ISO-L	6	3.10	3	12.5	105
0.8	M5	MTS06038C16 0.8 ISO	6	3.80	3	16.0	58
0.8	M5	MTS06038C16 0.8 ISO-L	6	3.80	3	16.0	105
1.0	M6	MTS06047C20 1.0 ISO	6	4.65	3	20.0	58
1.0	M6	MTS06047C20 1.0 ISO-L	6	4.65	3	20.0	105
1.25	M8	MTS0606C24 1.25 ISO	6	6.00	3	24.0	58

Order example: MTS 06047C14 1.0 ISO MT7

*Specially designed for the production of dental implants

- Machining Titanium, surgical stainless steels and hardened materials up to 45 HRC.
- Suitable for high speed air turbine machines (30,000-40,000 RPM) and for standard machining centers (6,000 RPM and higher).
- Can also be used for general purpose threading.

UN

Tools for Internal Thread

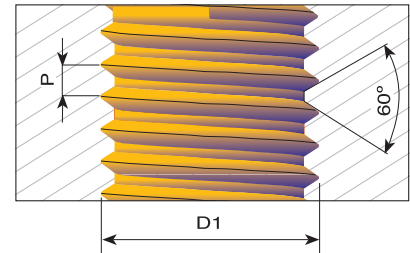
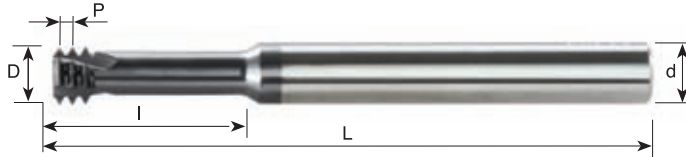

For thread depth up to 2 x D1

Pitch TPI	UNC	UNF	Ordering Code	d	D	No. of Flutes	I	L
72		1	MTS06014C3 72 UN	6	1.45	3	3.7	58
64	1	2	MTS06014C3 64 UN	6	1.40	3	3.8	58
56	2	3	MTS06016C4 56 UN	6	1.65	3	4.4	58
48	3	4	MTS06019C5 48 UN	6	1.90	3	5.2	58
40	4		MTS06021C6 40 UN	6	2.10	3	6.3	58
40	4		MTS06021C6 40 UN-L	6	2.10	3	6.3	105
40	5	6	MTS06024C7 40 UN	6	2.45	3	7.0	58
36		8	MTS06033C9 36 UN	6	3.30	3	9.0	58
32	6		MTS06025C7 32 UN	6	2.55	3	7.1	58
32	6		MTS06025C7 32 UN-L	6	2.55	3	7.1	105
32	8		MTS06032C9 32 UN	6	3.20	3	9.5	58
32	8		MTS06032C9 32 UN-L	6	3.20	3	9.5	105
32		10	MTS06037C10 32 UN	6	3.70	3	10.5	58
28		12	MTS06042C11 28 UN	6	4.20	3	11.0	58
28		1/4	MTS0605C14 28 UN	6	5.00	3	14.5	58
24	10,12		MTS06035C10 24 UN	6	3.50	3	10.6	58
24		5/16, 3/8	MTS08066C17 24 UN	8	6.60	3	17.0	64
20	1/4		MTS06047C14 20 UN	6	4.75	3	14.0	58
20		7/16	MTS0808C25 20 UN	8	8.00	3	25.0	64
18	5/16		MTS0606C17 18 UN	6	6.00	3	17.0	58
18		5/8	MTS1212D35 18 UN	12	12.00	4	35.0	84
16	3/8		MTS08067C22 16 UN	8	6.70	3	22.0	64
14	7/16		MTS08077C25 14 UN	8	7.70	3	25.0	64
13	1/2		MTS10092C27 13 UN	10	9.20	3	27.5	73
12	9/16		MTS12105C31 12 UN	12	10.50	3	31.5	84
11	5/8		MTS12114C34 11 UN	12	11.40	3	34.5	84
10	3/4		MTS16144D41 10 UN	16	14.40	4	41.5	105

Order example: MTS 06021C6 40 UN MT7

UN

Tools for Internal Thread

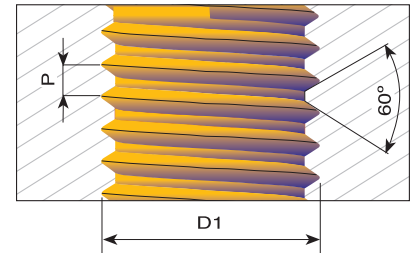
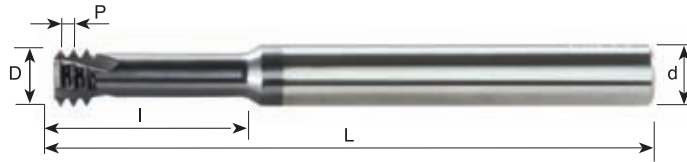

For thread depth up to 3 x D1

Pitch TPI	UNC	UNF	Ordering Code	d	D	No. of Flutes	I	L
80		0	MTS06012C4 80 UN	6	1.15	3	4.0	58
* 72		1	MTS03015C6 72 UN	3	1.45	3	6.0	39
56	2	3	MTS03016C6 56 UN	3	1.65	3	6.6	39
56	2	3	MTS06016C6 56 UN	6	1.65	3	6.6	58
56	2	3	MTS06016C6 56 UN-L	6	1.65	3	6.6	105
40	4		MTS06021C8 40 UN	6	2.10	3	8.0	58
40	4		MTS06021C8 40 UN-L	6	2.10	3	8.0	105
40	5	6	MTS06024C9 40 UN	6	2.45	3	9.6	58
32	6		MTS03025C10 32 UN	3	2.55	3	10.5	39
32	6		MTS06025C10 32 UN	6	2.55	3	10.5	58
32	6		MTS06025C10 32 UN-L	6	2.55	3	10.5	105
32	8		MTS06032C12 32 UN	6	3.20	3	12.5	58
32	8		MTS06032C12 32 UN-L	6	3.20	3	12.5	105
32		10	MTS06037C15 32 UN	6	3.70	3	15.0	58
32		10	MTS06037C15 32 UN-L	6	3.70	3	15.0	105
28		1/4	MTS0605C19 28 UN	6	5.00	3	19.0	58
28	1/4		MTS0605C19 28 UN-L	6	5.00	3	19.0	105
24		5/16, 3/8	MTS08066C24 24 UN	8	6.60	3	24.0	64
20	1/4		MTS06047C19 20 UN	6	4.75	3	19.0	58
20	1/4		MTS06047C19 20 UN-L	6	4.75	3	19.0	105
18	5/16		MTS0606C23 18 UN	6	6.00	3	23.0	58

Order example: MTS 0605C19 28 UN MT7

*Specially designed for the production of dental implants

- Machining Titanium, surgical stainless steels and hardened materials up to 45 HRC.
- Suitable for high speed air turbine machines (30,000-40,000 RPM) and for standard machining centers (6,000 RPM and higher).
- Can also be used for general purpose threading.

G 55° BSW, BSP

Same Tool for Internal and External Thread

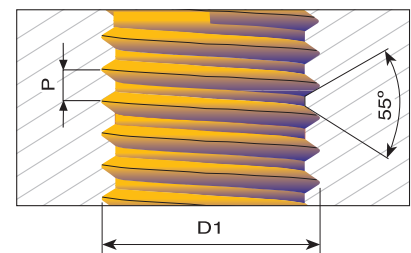
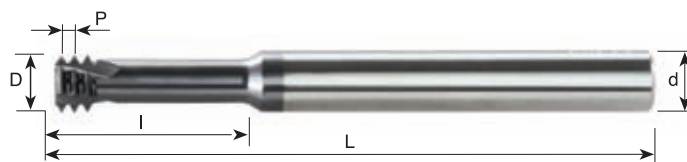

For thread depth up to 2 x D1

Pitch TPI	Standard	Ordering code	d	D	No. of Flutes	I	L
28	G 1/8	MTS08078C19 28 W	8	7.8	3	19.5	64
19	G 1/4 - 3/8	MTS1010D30 19 W	10	10.0	4	30.0	73
14	G 1/2 - 7/8	MTS1212D37 14 W	12	12.0	4	37.0	84
11	G ≥ 1	MTS1616D44 11 W	16	16.0	4	44.0	105

Order example: MTS 1212D37 14 W MT7

UNJ With internal coolant through the flutes

Tools for Internal Thread

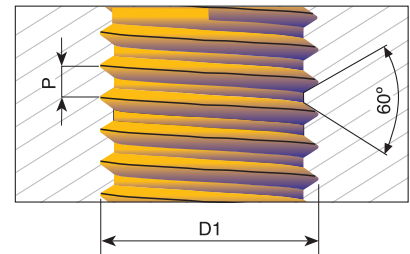
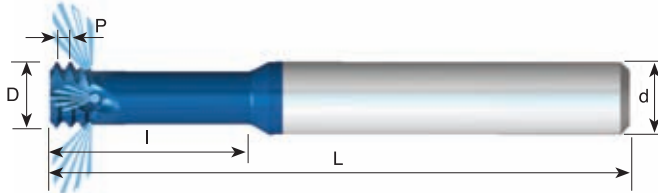

For thread depth up to 2.5 x D1

Pitch TPI	UNJC	UNJF	Ordering Code	d	D	No. of Flutes	I	L
*32	8	10	MTS06033C10 32 UNJ	6	3.30	3	10.5	58
28		1/4	MTS08051C16 28 UNJ	8	5.10	3	16.0	64
24		5/16, 3/8	MTS08067C20 24 UNJ	8	6.70	3	20.0	64
*20	1/4		MTS06049C16 20 UNJ	6	4.90	3	16.0	58
20		7/16	MTS0808C28 20 UNJ	8	8.00	3	28.0	64
18	5/16	9/16	MTS08061C20 18 UNJ	8	6.15	3	20.0	64
16	3/8		MTS08069C24 16 UNJ	8	6.90	3	24.0	64
14	7/16		MTS08079C25 14 UNJ	8	7.90	3	25.0	64
13	1/2		MTS10094C27 13 UNJ	10	9.40	3	27.5	73

* Cutters without coolant

Order example: MTS 06049C16 20 UNJ MT8

Carbide grade MT8 Sub Micron grade with advanced PVD triple coating (ISO K 10-K20). Extremely high resistant and smooth cutting operation, for high performance, and normal machining conditions. General purpose for all materials

MJ With internal coolant through the flutes

Tools for Internal Thread

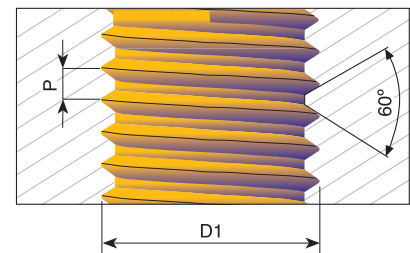
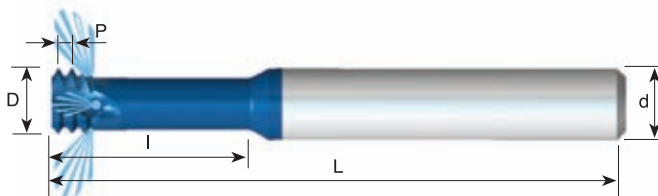

For thread depth up to 2.5 x D1

Pitch mm	D1	Ordering Code	d	D	No. of Flutes	I	L
* 0.7	MJ4	MTS06032C10 0.7 MJ	6	3.20	3	10.0	58
* 0.8	MJ5	MTS06039C12 0.8 MJ	6	3.90	3	12.5	58
* 1.0	MJ6	MTS06048C15 1.0 MJ	6	4.80	3	15.0	58
1.25	MJ8	MTS08061C20 1.25 MJ	8	6.10	3	20.0	64
1.5	MJ10	MTS0808C25 1.5 MJ	8	8.00	3	25.0	64
1.75	MJ12	MTS10092C30 1.75 MJ	10	9.20	3	30.0	73
2.0	MJ14, MJ16	MTS1010C35 2.0 MJ	10	10.00	3	35.0	73

* Cutters without coolant

Order example: MTS 06048C15 1.0 MJ MT8

Carbide grade MT8 Sub Micron grade with advanced PVD triple coating (ISO K 10-K20). Extremely high resistant and smooth cutting operation, for high performance, and normal machining conditions. General purpose for all materials

Partial Profile 60°

Same tool for Internal and External Thread

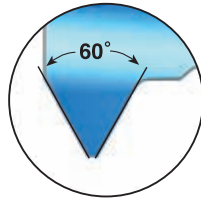

Detail A

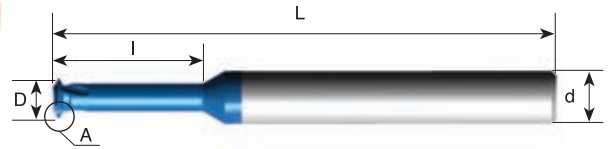

Pitch mm	Pitch TPI	Ordering Code	M Coarse	M Fine	UN, UNC, UNS UNF, UNEF	d	D	No. of Flutes	I	L
0.25-0.35	100-72	MTI03012C3 A60	M1.6 x 0.35	M1.6 x 0.25 M1.8 x 0.25 M2.0 x 0.25	0-80 UNF	3	1.15	3	3.1	39
0.35-0.45	72-56	MTI03014C4 A60	M2 x 0.4 M2.2 x 0.45	M2 x 0.35 M2.2 x 0.35	1-64 UNC, 1-72 UNF, 2-56 UNC, 2-64 UNF	3	1.40	3	3.7	39
0.35-0.6	72-40	MTI03019C5 A60	M2.5 x 0.45	M2.5 x 0.35 M3 x 0.35	3-48 UNC, 3-56 UNF, 4-40 UNC, 4-48 UNF	3	1.90	3	5.2	39
0.5-0.8	48-32	MTI03024C7 A60	M3 x 0.5 M3.5 x 0.6	M3.5 x 0.5	5-40 UNC, 5-44 UNF, 6-32 UNC, 6-40 UNF	3	2.45	3	7.0	39
0.5-1.0	48-24	MTI06032C9 A60	M4 x 0.7 M4.5 x 0.75	M4 x 0.5	8-32 UNC, 8-36 UNF, 10-24 UNC, 10-28 UNS 10-32 UNF	6	3.20	3	9.5	58
0.5-1.0	48-24	MTI0604C12 A60	M5 x 0.8 M6 x 1.0	M5 x 0.5 M5.5 x 0.5 M5 x 0.75	10-36 UNS, 10-40 UNS, 10-48 UNS, 12-24 UNC, 12-28 UNF	6	4.00	3	12.5	58

Order example: MTI 03024C7 A60 MT11

Carbide grade: MT11 with triple blue coating

With internal coolant through the flutes

Same Tool for Internal and External Thread

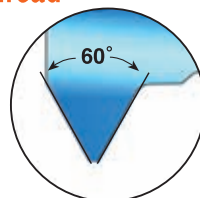

Detail A

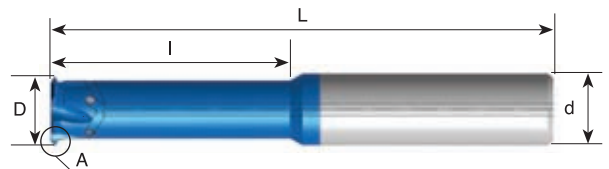

For threading deep parts

Pitch mm	Pitch TPI	Thread Dia. (min.)	Ordering Code	d	D	No. of Flutes	I	L
Int. 0.5 - 0.8 Ex. 0.4 - 0.8	56-28 64-32	$\varnothing \geq 6$	MTI0605D20 A60	6	5.0	4	20	58
		$\varnothing \geq 9$	MTI0808D28 A60	8	8.0	4	28	64
		$\varnothing \geq 13$	MTI1212E38 A60	12	12.0	5	38	84
Int. 1.0 - 1.75 Ex. 0.8 - 1.5	28-14 32-16	$\varnothing \geq 10$	MTI0808D30 A60	8	8.0	4	30	64
		$\varnothing \geq 12$	MTI1010D35 A60	10	10.0	4	35	73
		$\varnothing \geq 14$	MTI1212E39 A60	12	12.0	5	39	84
Int. 2.0 - 3.0 Ex. 1.75-2.5	13- 8 15-10	$\varnothing \geq 16$	MTI1212E40 A60	12	12.0	5	40	84
		$\varnothing \geq 18$	MTI1614E45 A60	16	14.0	5	45	101
		$\varnothing \geq 20$	MTI1616E50 A60	16	16.0	5	50	101

Order example: MTI 0808D28 A60 MT8

Carbide grade: MT8 with triple blue coating

Partial Profile 55°

Same tool for Internal and External Thread

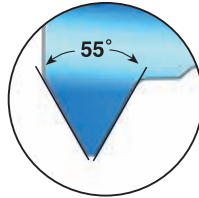

Detail A

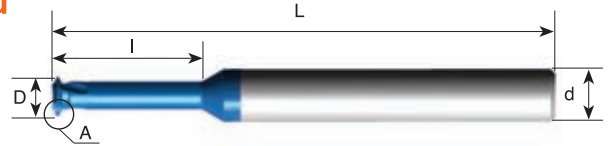

Pitch TPI	Ordering Code	d	D	No. of Flutes	I	L
40-32	MTI03023C7 A55	3	2.25	3	7.0	39
28-20	MTI06044C14 A55	6	4.35	3	14.0	58
28-18	MTI06059C20 A55	6	5.85	3	20.5	58
20-14	MTI0807C23 A55	8	7.00	3	23.0	64

Order example: MTI 06046C14A55 MT11

Carbide grade: MT11 with triple blue coating

ISO

Tools for Internal Thread

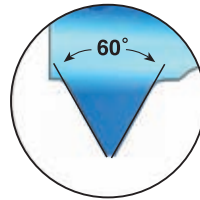

Detail A

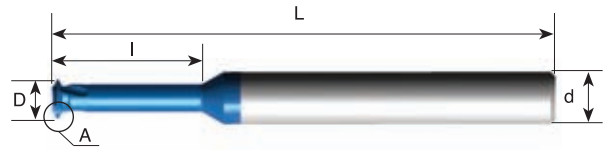

For thread depth up to $3.5 \times D1$

Pitch mm	M Coarse	M Fine	Ordering Code	d	D	No. of Flutes	I	L
0.25	M1 x 0.25		MTI03007C3 0.25 ISO	3	0.72	3	3.6	39
0.25	M1.2 x 0.25	M1.4 x 0.25 M1.6 x 0.25	MTI03009C4 0.25 ISO	3	0.90	3	4.3	39
0.3	M1.4 x 0.3		MTI03011C5 0.3 ISO	3	1.05	3	5.0	39
0.35	M1.6 x 0.35	M2 x 0.35 M2.2 x 0.35	MTI03012C6 0.35 ISO	3	1.20	3	5.7	39
0.4	M2 x 0.4		MTI03016C7 0.4 ISO	3	1.55	3	7.1	39
0.5	M3 x 0.5	M3.5 x 0.5 M4 x 0.5	MTI03024C10 0.5 ISO	3	2.37	3	10.6	39

Order example: [MTI 03012C6 0.35 ISO](#) [MT11](#)

Carbide grade: **MT11** with triple blue coating

UN

Tools for Internal Thread

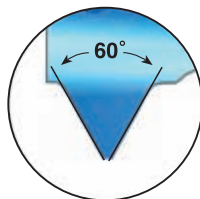

Detail A

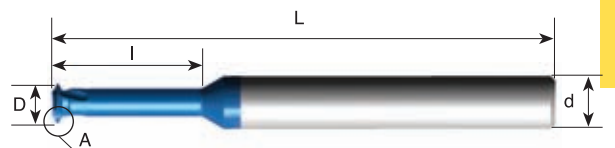

For thread depth up to $3.5 \times D1$

Pitch TPI	UNC	UNF	Ordering Code	d	D	No. of Flutes	I	L
80		0	MTI03012C5 80 UN	3	1.15	3	5.5	39
72		1	MTI03015C7 72 UN	3	1.45	3	6.6	39
56	2	3	MTI03016C9 56 UN	3	1.65	3	8.9	39
40	4		MTI03021C10 40 UN	3	2.10	3	10.1	39

Order example: [MTI 03016C9 56 UN](#) [MT11](#)

Carbide grade: **MT11** with triple blue coating

DMT 3 in 1 - *Drill, Thread, Chamfer

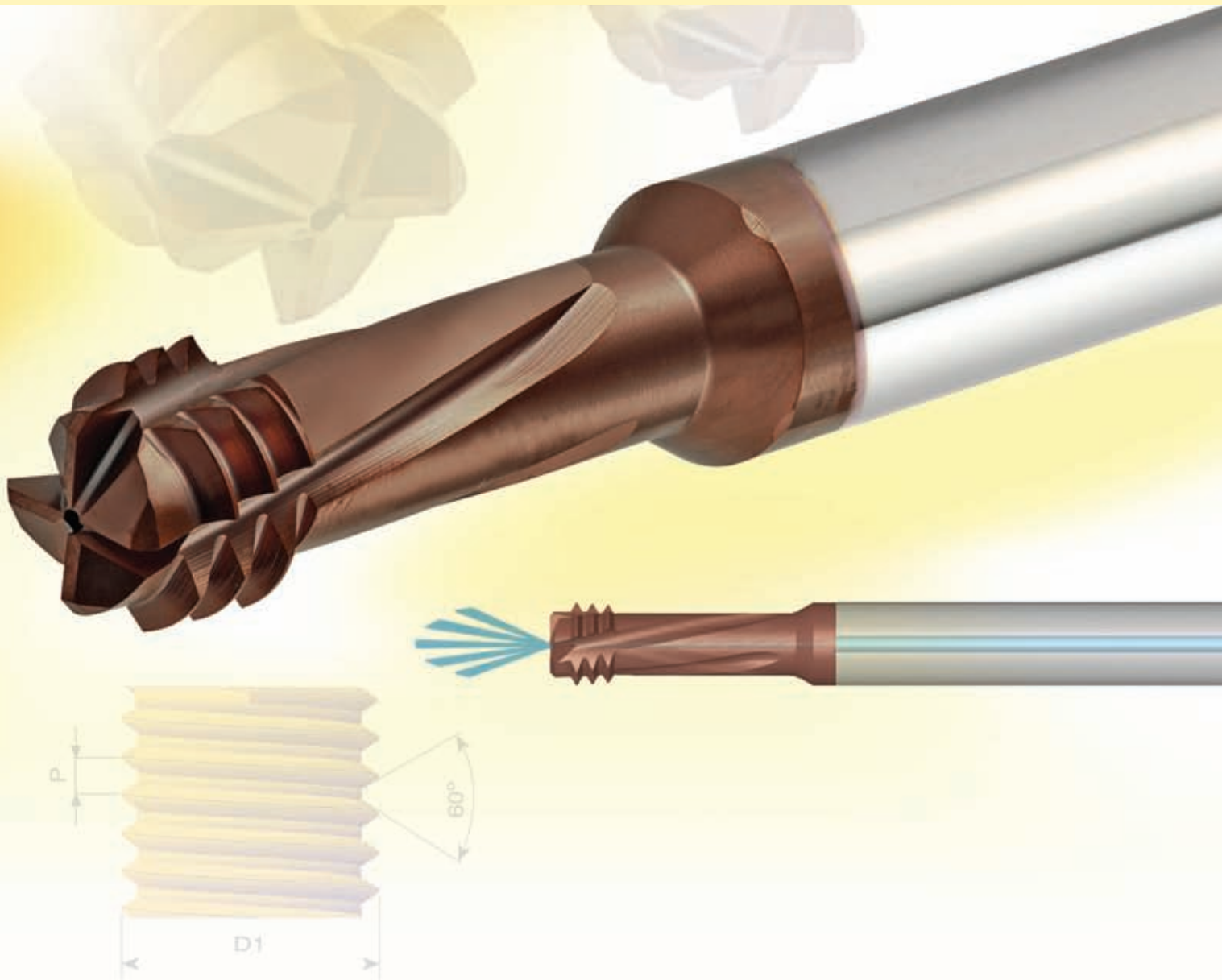

High Performance tools with internal coolant supply for the production of internal threads.
***Circular movement produces the thread hole, the thread and a chamfer in one work process.**

Carbide grade: MT7 Sub-micron grade with Titanium Aluminium Nitride multi-layer coating (ISO K10-K20).

Advantages DMT

- Cancels the need for drilling the hole.
- Short cycle time and high performance reduces machining costs.
- Suitable for both blind and through holes.
- Full Profile thread.
- No time lost for tool change, since drilling, chamfering and thread milling are done with one tool.
- Same tool for right-hand or left-hand threads.
- Cuts a wide range of materials.

Contents:

Page:

Product Identification
ISO
UN

134
135
136

Product Identification

DMT 3 in 1 - *DRILL, THREAD, CHAMFER Ordering Codes

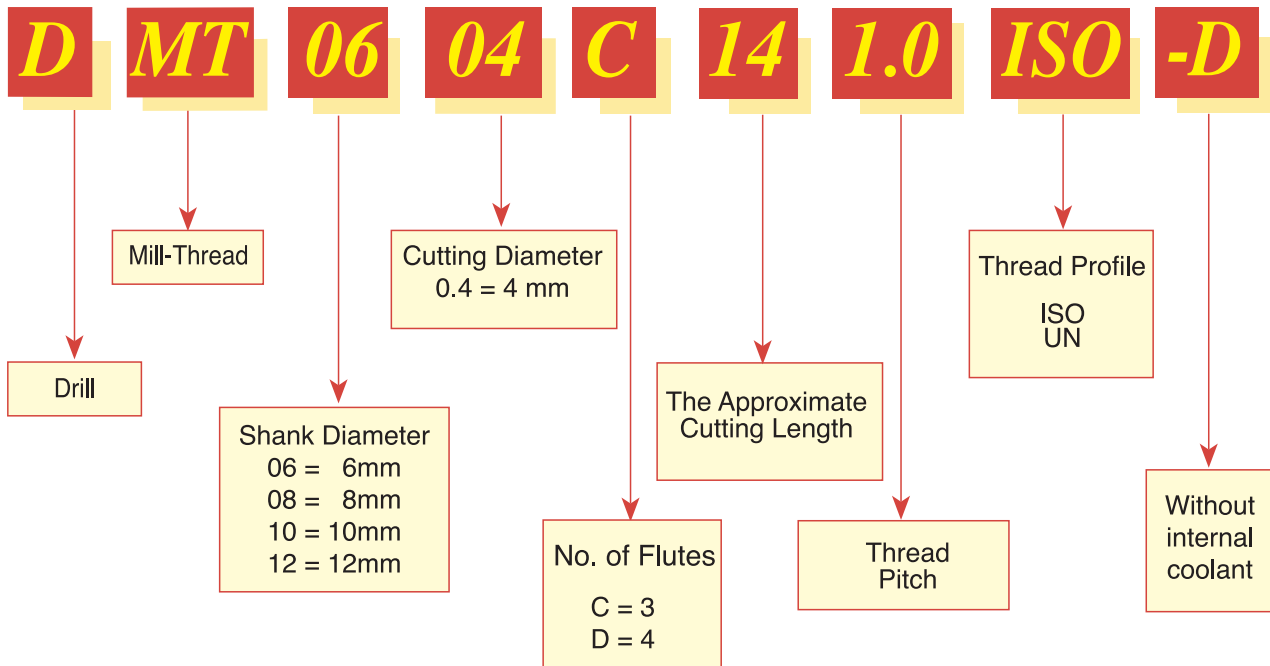

ISO with internal coolant bore

Tools for Internal Thread

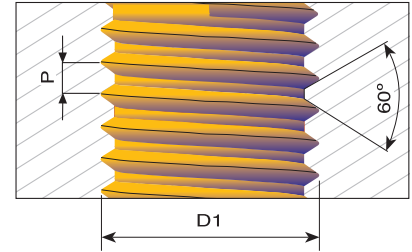
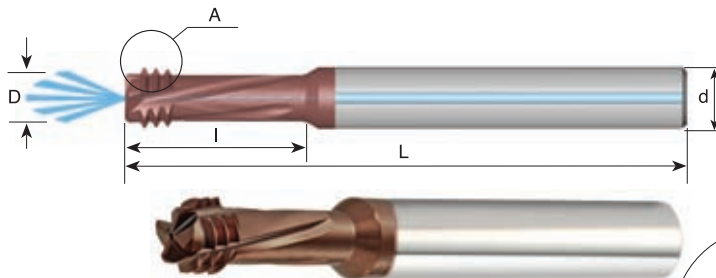

Left hand cutting
For CNC code use M04

For thread depth up to 2 x D1

Detail A

Pitch mm	D1	Ordering Code	d	D	No. of Flutes	I	W	V	L
1.0	M6 - M9	DMT08047C14 1.0 ISO	8	4.70	3	14.0	0.4	1.0	64
1.25	M8 - M12	DMT08061D18 1.25 ISO	8	6.10	4	18.0	0.5	1.25	64
1.5	M10-M15	DMT08078D23 1.5 ISO	8	7.80	4	23.0	0.6	1.5	64
1.75	M12	DMT1009D26 1.75 ISO	10	9.00	4	26.0	0.6	1.75	73
2.0	M16-M23	DMT12118D35 2.0 ISO	12	11.80	4	35.0	0.6	2.0	84

Order example: DMT 06032C11 0.7 ISO MT7

Carbide grade MT7 Sub-Micron grade with Titanium Aluminum Nitride multi-layer coating (ISO K10 - K20). To be run at medium to high cutting speeds. General purpose for all materials.

ISO without internal coolant

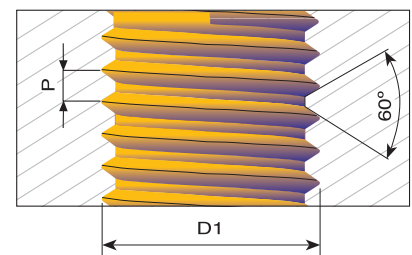
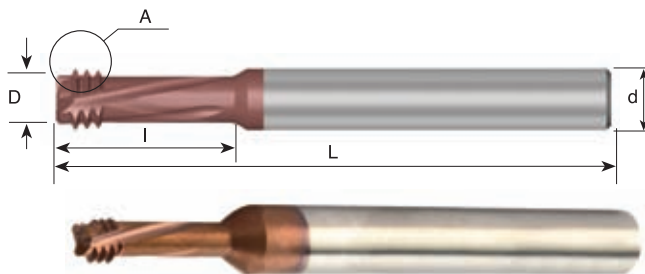

Left hand cutting
For CNC code use M04

For thread depth up to 2.5xD1

Detail A

Pitch mm	D1	Ordering Code	d	D	No. of Flutes	I	W	V	L
0.7	M4	DMT06032C11 0.7 ISO-D	6	3.15	3	11.6	0.2	0.7	58
0.8	M5	DMT0604C14 0.8 ISO-D	6	4.00	3	14.4	0.3	0.8	58

Order example: DMT 06032C11 0.7 ISO-D MT7

Carbide grade MT7: Sub-Micron grade with Titanium Aluminum Nitride multi-layer coating (ISO K10 - K20). To be run at medium to high cutting speeds. General purpose for all materials.

UN with internal coolant bore

Tools for Internal Thread

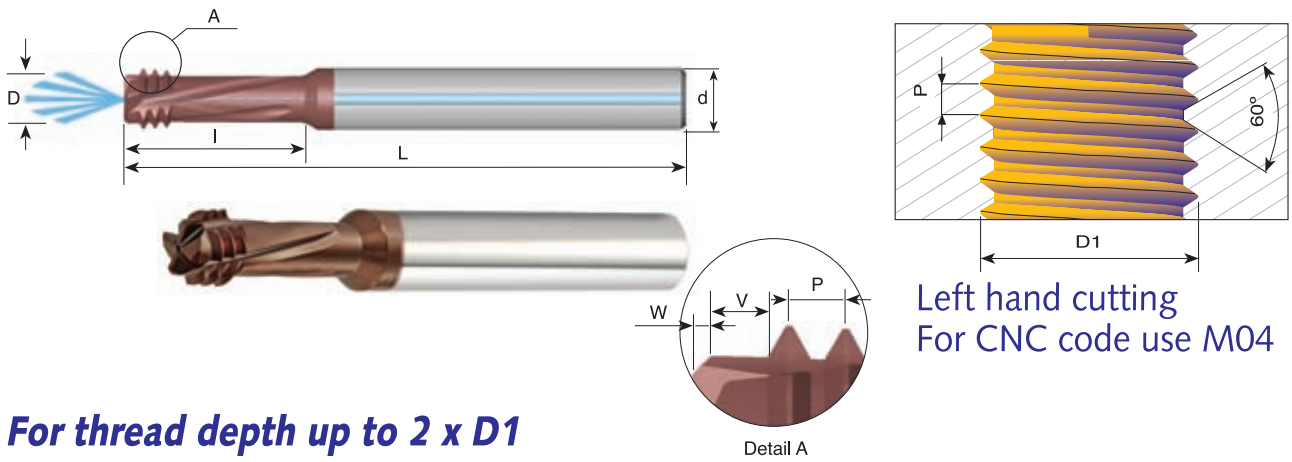

For thread depth up to 2 x D1

Pitch TPI	UN, UNEF, UNF UNC, UNS	Ordering Code	d	D	No. of Flutes	I	W	V	L
28	1/4 - 3/8	DMT0805C14 28 UN	8	5.00	3	14.5	0.4	0.9	64
24	5/16 - 1/2	DMT08065D17 24 UN	8	6.50	4	17.0	0.5	1.05	64
20	1/4 - 3/8	DMT08048C14 20 UN	8	4.80	3	14.0	0.4	1.25	64
18	5/16 - 7/16	DMT0806D17 18 UN	8	6.00	4	17.0	0.5	1.4	64
16	3/8 - 1/2	DMT08067C22 16 UN	8	6.70	3	22.0	0.5	1.6	64

Order example: DMT 08067C 22 16 UN MT7

UN without internal coolant

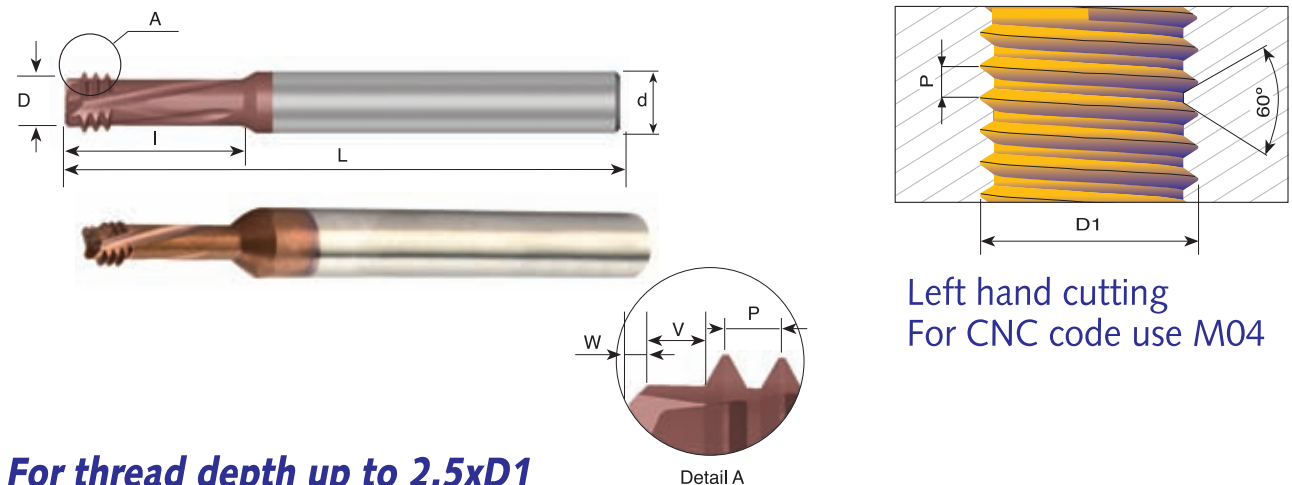

For thread depth up to 2.5xD1

Pitch TPI	UNC	UNF	Ordering Code	d	D	No. of Flutes	I	W	V	L
36		8	DMT06033C12 36 UN-D	6	3.30	3	12.0	0.2	0.7	58
32	8		DMT06032C12 32 UN-D	6	3.20	3	12.3	0.3	0.8	58
32		10	DMT06038C14 32 UN-D	6	3.80	3	14.0	0.3	0.8	58

Order example: DMT 06032C 12 32 UN-D MT7



MTSH Type

C.P.T. is pioneer in offering solid carbide thread mills tools designed specifically for the machining of hardened materials up to 62HRc. These tools provide high performance, improved cut and an excellent surface finish.

HARDCUT MTSH & MTH Types

Carbide grade: MT9/MT11 - Ultra fine sub-micron grade with Advanced PVD Triple Coating

MTH Type

C.P.T. provide new innovative mill thread solid carbide tools for machining:

- Hardened steels and cast iron up to 62 HRc.
- High temperature alloys.
- Titanium alloys.
- Super Alloys (Hastelloy, Inconel, Nickel Base Alloys).

- Threading from M1.4 x 0.3
- Perfect solution for the Die and Mold industry
- Working at high cutting speeds
- Short machining time
- Low cutting forces thanks to the short profile

Advantages

- Same tool performs thread milling and chamfering - saves machining time.
- Increased cutting diameter - better rigidity and stability.
- Coating provides high wear and heat resistance.
- Ultra fine grade - dedicated for hardened materials.
- Short chips are produced, insure high process security.
- Short cycle time - increases productivity.
- Thread length up to 2xD.

Contents:

Page:

Product Identification	138
Mini Mill-Thread HARDCUT	
ISO	139
UN	140
MTH Type	
ISO	141
UN	142

Product Identification

Mini Mill-Thread MTSH Type Ordering Codes

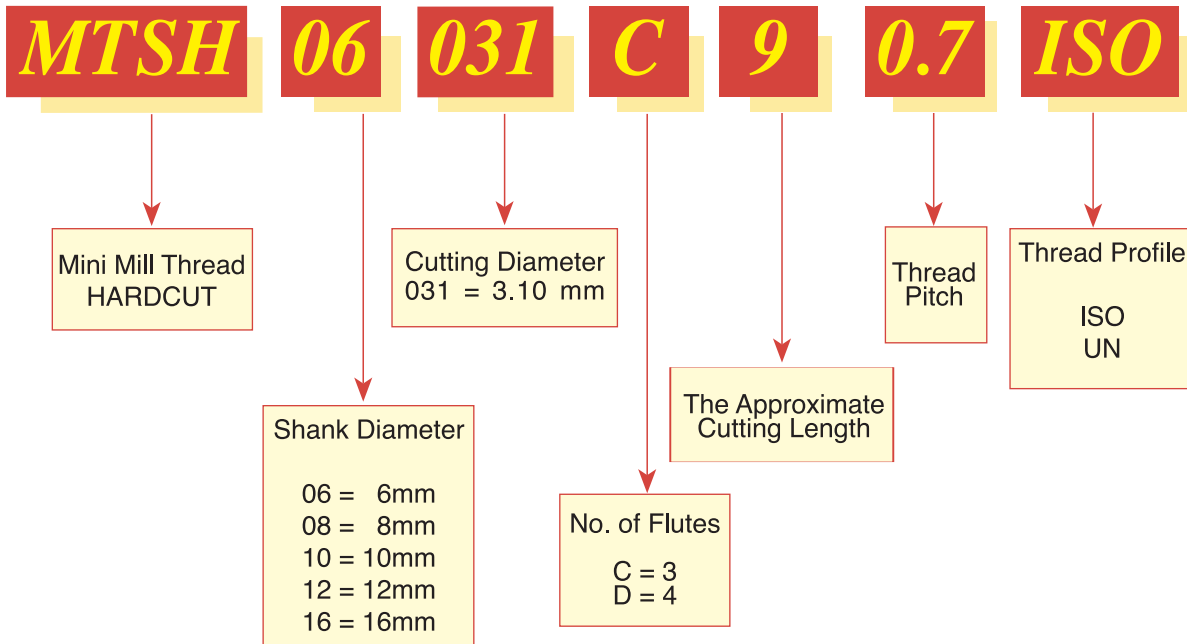

MTH Type Ordering Codes

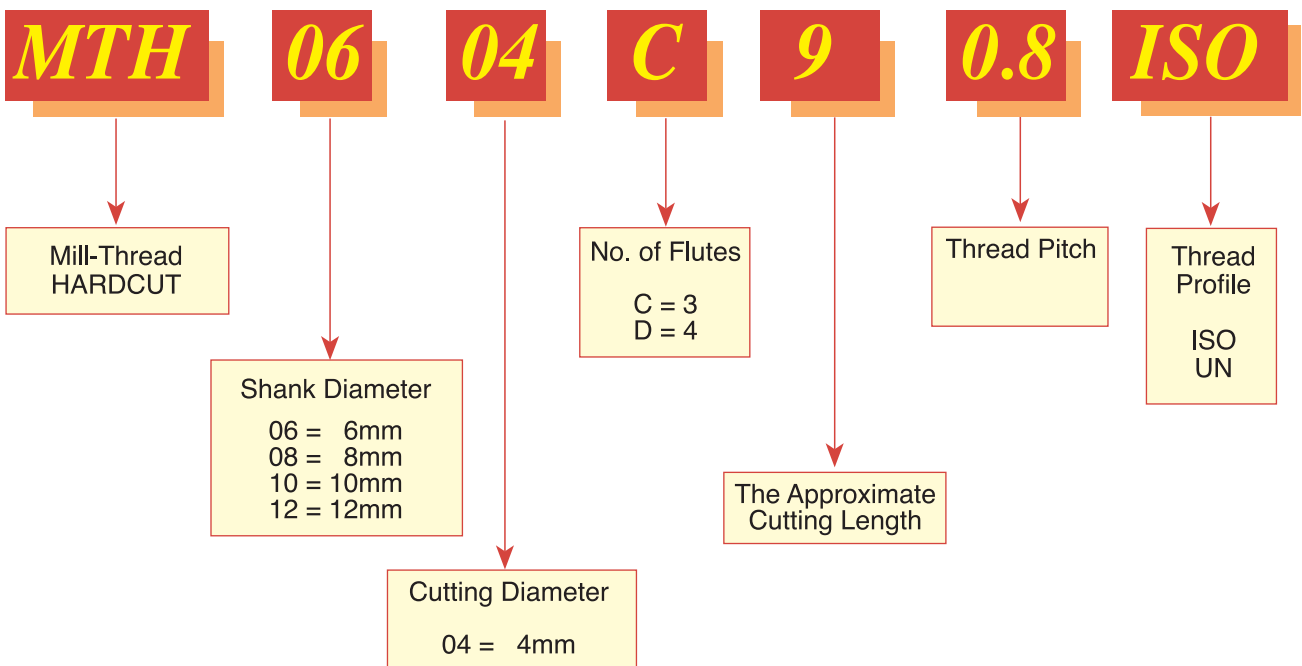

ISO

Tools for Internal Thread

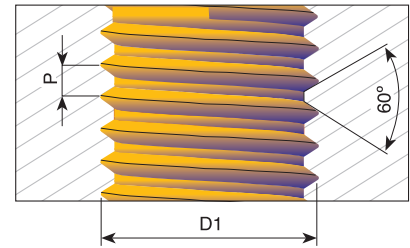
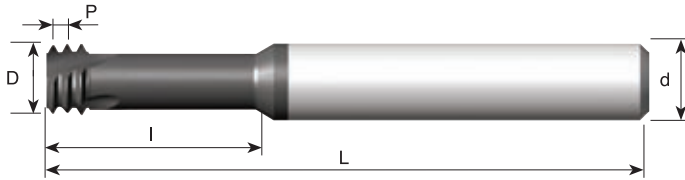

Left hand cutting
For CNC code use M04

For thread depth up to $2xD1$

Pitch mm	D1	Ordering Code	d	D	No. of Flutes	I	L
0.4	M2	MTSH06016C4 0.4 ISO	6	1.53	3	4.5	58
0.45	M2.2	MTSH06017C5 0.45 ISO	6	1.65	3	5.0	58
0.45	M2.5	MTSH0602C5 0.45 ISO	6	1.95	3	5.5	58
0.5	M3	MTSH06024C6 0.5 ISO	6	2.37	3	6.5	58
0.6	M3.5	MTSH06028C7 0.6 ISO	6	2.75	3	7.5	58
0.7	M4	MTSH06031C9 0.7 ISO	6	3.10	3	9.0	58
0.8	M5	MTSH06038C12 0.8 ISO	6	3.80	3	12.5	58
1.0	M6	MTSH06047C14 1.0 ISO	6	4.65	3	14.0	58
1.25	M8	MTSH0606C18 1.25 ISO	6	6.00	3	18.0	58
1.5	M10	MTSH08078C23 1.5 ISO	8	7.80	3	23.0	64
1.75	M12	MTSH1009C26 1.75 ISO	10	9.00	3	26.0	73
2.0	M16	MTSH12118D35 2.0 ISO	12	11.80	4	35.0	84

For thread depth up to $3xD1$

Pitch mm	D1	Ordering Code	d	D	No. of Flutes	I	L
0.3	M1.4	MTSH03011C4 0.3 ISO	3	1.05	3	4.0	39
0.35	M1.6	MTSH03012C5 0.35 ISO	3	1.20	3	4.8	39
0.4	M2	MTSH03016C6 0.4 ISO	3	1.53	3	6.0	39
0.45	M2.2	MTSH06017C7 0.45 ISO	6	1.65	3	7.0	58
0.45	M2.5	MTSH0602C7 0.45 ISO	6	1.95	3	7.5	58
0.5	M3	MTSH06024C9 0.5 ISO	6	2.37	3	9.5	58
0.6	M3.5	MTSH06028C10 0.6 ISO	6	2.75	3	10.5	58
0.7	M4	MTSH06031C12 0.7 ISO	6	3.10	3	12.5	58
0.8	M5	MTSH06038C16 0.8 ISO	6	3.80	3	16.0	58
1.0	M6	MTSH06047C20 1.0 ISO	6	4.65	3	20.0	58
1.25	M8	MTSH0606C24 1.25 ISO	6	6.00	3	24.0	58

Order example: MTSH 06031C9 0.7 ISO MT9

UN

Tools for Internal Thread

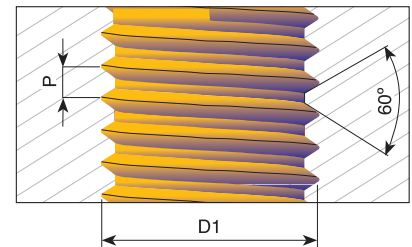
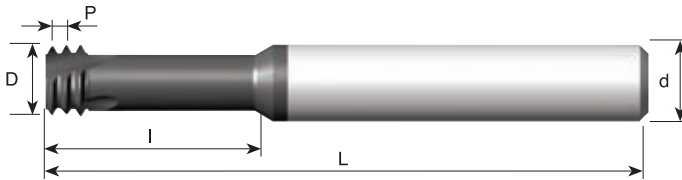

For thread depth up to 2xD1

Left hand cutting
For CNC code use M04

Pitch TPI	UNC	UNF	Ordering Code	d	D	No. of Flutes	I	L
72		1	MTSH06014C3 72 UN	6	1.45	3	3.7	58
64	1	2	MTSH06014C3 64 UN	6	1.40	3	3.8	58
56	2	3	MTSH06016C4 56 UN	6	1.65	3	4.4	58
48	3	4	MTSH06019C5 48 UN	6	1.90	3	5.2	58
40	4		MTSH06021C6 40 UN	6	2.10	3	6.3	58
40	5	6	MTSH06024C7 40 UN	6	2.45	3	7.0	58
36		8	MTSH06033C9 36 UN	6	3.30	3	9.0	58
32	6		MTSH06025C7 32 UN	6	2.55	3	7.1	58
32	8		MTSH06032C9 32 UN	6	3.20	3	9.5	58
32		10	MTSH06037C10 32 UN	6	3.70	3	10.5	58
28		12	MTSH06042C11 28 UN	6	4.20	3	11.0	58
28		1/4	MTSH0605C14 28 UN	6	5.00	3	14.5	58
24	10,12		MTSH06035C10 24 UN	6	3.50	3	10.6	58
24		5/16, 3/8	MTSH08066C17 24 UN	8	6.60	3	17.0	64
20	1/4		MTSH06047C14 20 UN	6	4.75	3	14.0	58
20		7/16	MTSH0808C25 20 UN	8	8.00	3	25.0	64
18	5/16		MTSH0606C17 18 UN	6	6.00	3	17.0	58
18		5/8	MTSH1212D35 18 UN	12	12.00	4	35.0	84
16	3/8		MTSH08067C22 16 UN	8	6.70	3	22.0	64
14	7/16		MTSH08077C25 14 UN	8	7.70	3	25.0	64
13	1/2		MTSH10092C27 13 UN	10	9.20	3	27.5	73
12	9/16		MTSH12105C31 12 UN	12	10.50	3	31.5	84
11	5/8		MTSH12114C34 11 UN	12	11.40	3	34.5	84

For thread depth up to 3xD1

Pitch TPI	UNC	UNF	Ordering Code	d	D	No. of Flutes	I	L
80		0	MTSH06012C4 80 UN	6	1.15	3	4.0	58
72		1	MTSH03015C6 72 UN	3	1.45	3	6.0	39
56	2	3	MTSH06016C6 56 UN	6	1.65	3	6.6	58
40	4		MTSH06021C8 40 UN	6	2.10	3	8.0	58
40	5	6	MTSH06024C9 40 UN	6	2.45	3	9.6	58
32	6		MTSH06025C10 32 UN	6	2.55	3	10.5	58
32	8		MTSH06032C12 32 UN	6	3.20	3	12.5	58
32		10	MTSH06037C15 32 UN	6	3.70	3	15.0	58
28		1/4	MTSH0605C19 28 UN	6	5.00	3	19.0	58
24		5/16, 3/8	MTSH08066C24 24 UN	8	6.60	3	24.0	64
20	1/4		MTSH06047C19 20 UN	6	4.75	3	19.0	58
18	5/16		MTSH0606C23 18 UN	6	6.00	3	23.0	58

Order example: MTSH 06047C14 20 UN MT9

ISO

Tools for Internal Thread

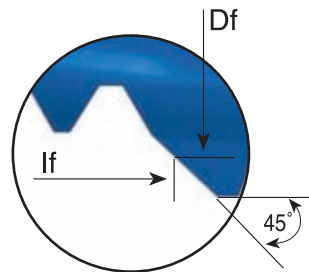

Detail A

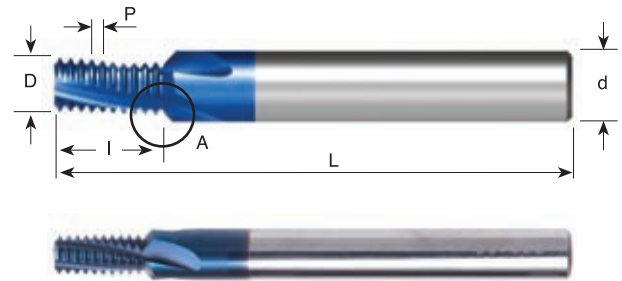

Pitch mm	M coarse	M fine	Ordering Code	d	D	Df	No. of Flutes	I	lf	L
0.5	M3	$\varnothing \geq 4$	MTH06024C5 0.5 ISO	6	2.4	3.6	3	5.3	5.9	58
0.7	M4	$\varnothing \geq 5$	MTH06031C7 0.7 ISO	6	3.1	4.3	3	7.4	8.0	58
0.8	M5	$\varnothing \geq 6$	MTH0604C9 0.8 ISO	6	4.0	5.2	3	9.2	9.8	58
1.0	M6	$\varnothing \geq 7$	MTH08048D10 1.0 ISO	8	4.8	6.4	4	10.5	11.3	64
1.0		$\varnothing \geq 9$	MTH0806D13 1.0 ISO	8	6.0	7.6	4	13.5	14.3	64
1.0		$\varnothing \geq 10$	MTH1008D16 1.0 ISO	10	8.0	9.6	4	16.5	17.3	73
1.25	M8	$\varnothing \geq 10$	MTH0806D14 1.25 ISO	8	6.0	7.6	4	14.4	15.2	64
1.5	M10	$\varnothing \geq 12$	MTH1008D17 1.5 ISO	10	8.0	9.8	4	17.3	18.2	73
1.5		$\varnothing \geq 14$	MTH1210D21 1.5 ISO	12	10.0	11.8	4	21.8	22.7	84
1.75	M12	$\varnothing \geq 12$	MTH12095D20 1.75 ISO	12	9.5	11.5	4	20.1	21.1	84

Order example: MTH08048D10 1.0 ISO MT11

UN

Tools for Internal Thread

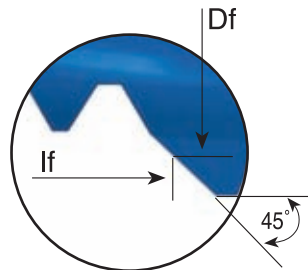

Detail A

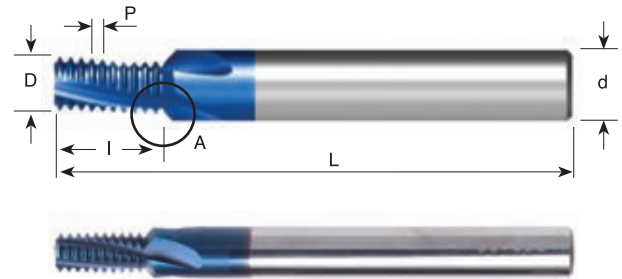

Pitch TPI	UNC	UNF	UNEF	Ordering Code	d	D	Df	No. of Flutes	I	If	L
40	5	6		MTH06025C6 40 UN	6	2.5	3.7	3	6.0	6.6	58
32	6			MTH06026C5 32 UN	6	2.6	3.8	3	5.9	6.5	58
32	8			MTH06032C7 32 UN	6	3.2	4.4	3	7.5	8.1	58
32		10	12	MTH06038C9 32 UN	6	3.8	5.0	3	9.1	9.7	58
28		1/4		MTH08052D11 28 UN	8	5.2	6.8	4	11.3	12.1	64
28			7/16, 1/2	MTH12096D20 28 UN	12	9.6	11.2	4	20.4	21.2	84
24		5/16, 3/8	9/16, 5/8, 11/16	MTH08066D14 24 UN	8	6.6	8.0	4	14.3	15.0	64
20	1/4			MTH06048C12 20 UN	6	4.8	6.0	3	12.1	12.7	58
20		7/16, 1/2	3/4, 1	MTH12092D21 20 UN	12	9.2	10.8	4	21.0	21.8	84
18	5/16	9/16, 5/8	11/16	MTH08057C14 18 UN	8	5.7	7.5	3	14.8	15.7	64
16	3/8	3/4		MTH10074C16 16 UN	10	7.4	9.2	3	16.7	17.6	73
14	7/16	7/8		MTH10085D20 14 UN	10	8.5	9.9	4	20.9	21.6	73
13	1/2			MTH12094D22 13 UN	12	9.4	11.4	4	22.5	23.5	84

Order example: MTH06048C12 20 UN MT11

Mill-Thread Technical Section



Contents:

Page:

Conversion of Cutting Speed to Rotational Speed	144
Tool Selection	145
Carmex Mill-Thread Catalogue and CNC Programming Software	146
Example of Thread Milling CNC Program for Internal Threading	146
Mill-Thread Inserts Carbide Grades, Speed and Feed Selection	147
Spiral Mill-Thread Inserts, Speed and Feed Selection	147
Spiral Finish, Speed and Feed Selection	148

Contents:

Page:

D-Thread type	149
CMT type	150
Mill-Thread Solid Carbide Grades, Speed and Feed Selection	150
DMT type	151
MT, MTB, MTZ, EMT types	151
MTQ type	152
Mini Mill-Thread (MTS) and MTI types	153
Mini Mill-Thread (MTSH) type	154
MTH type	155

Conversion of Cutting Speed to Rotational Speed

Conversion of selected cutting speed to rotational speed is calculated by the following formula:

$$N = \frac{V \times 1000}{\pi \times D} = \frac{120 \times 1000}{3.14 \times 30} = 1274 \text{ RPM}$$

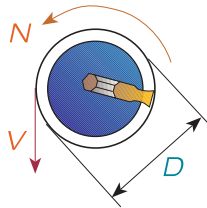

Example: $V=120 \text{ m/min}$
 $D=30 \text{ mm}$

D=Cutting diameter

Internal Thread

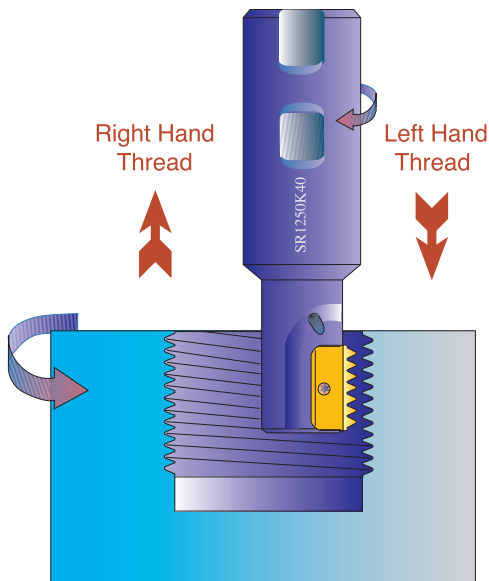

External Thread

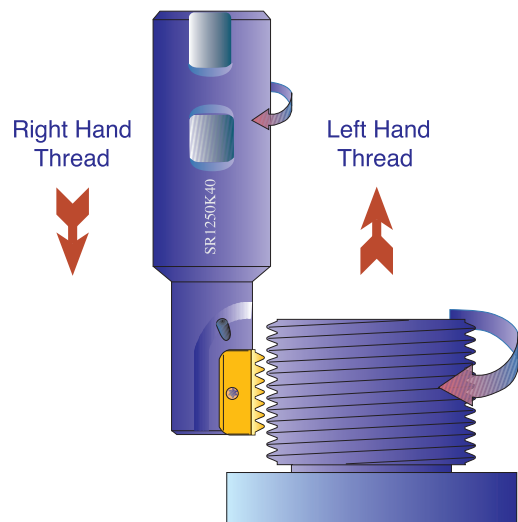

Tool Selection

For indexable and solid carbide Mill Threads

The following chart provides a fairly accurate visual selection tool for Internal Threading.

The chart is suitable for the following thread forms: ISO, UN, WHIT, NPT, NPTF, BSPT and PG.

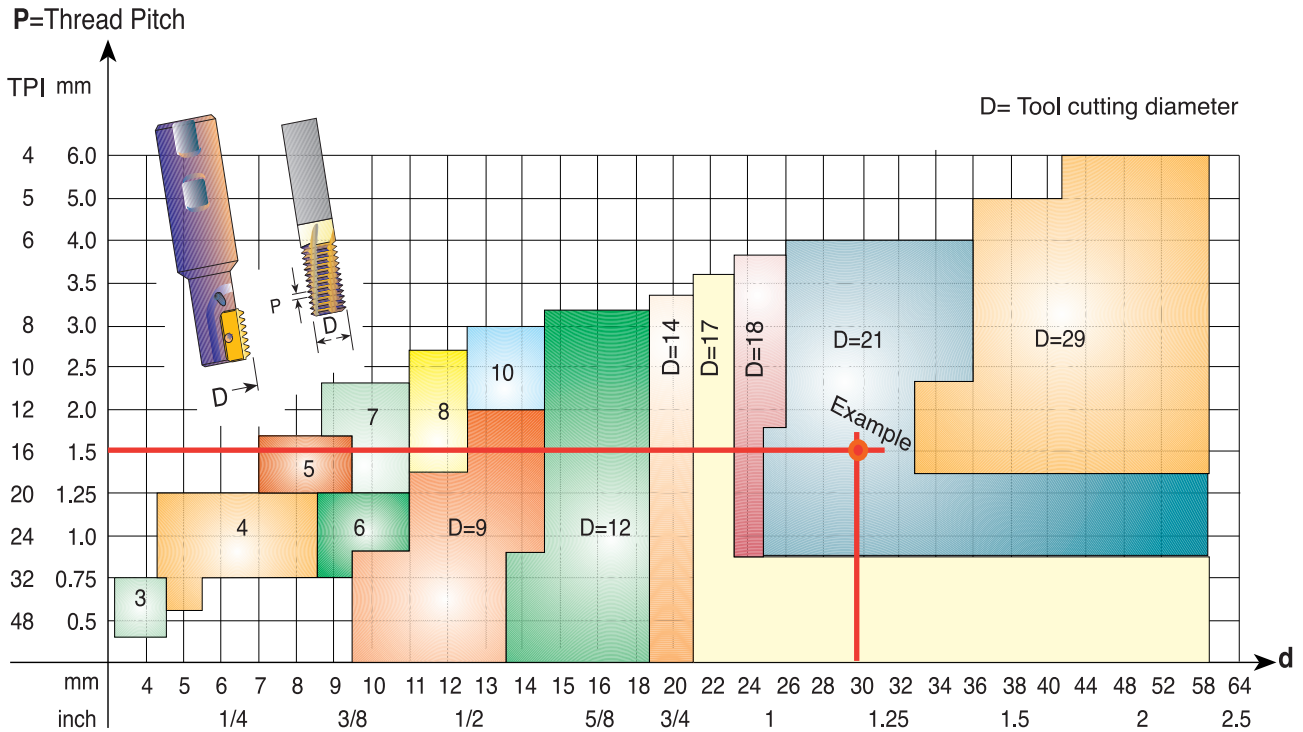

Any tool with a small cutting diameter can produce large diameter threads.

Example: Internal thread M30 x 1.5:

Find a Milling Tool to produce d=30 mm Internal right hand ISO thread with a thread pitch P=1.5 mm.

As can be seen from the chart above, the two red lines intersect at a selected tool with a cutting diameter of D=21 mm.

Chosen toolholder: SR0021H21

Insert: 21 I 1.5 ISO MT7

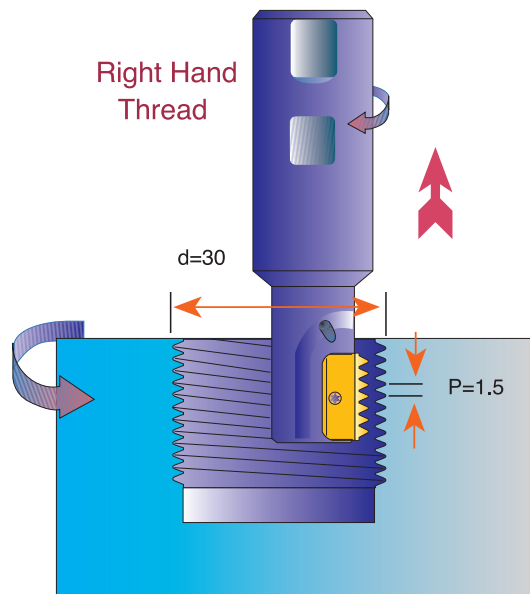

If you need assistance, please call your local distributor and ask for help in selecting the appropriate tool as well as for a CNC program to suit your CNC milling machine.

Carmex Mill-Thread catalogue and CNC programming Software

This software is provided by Carmex to assist you, the thread milling user, to select and apply the correct tool to machine threads on CNC machining centers. The program will find tools and inserts which are suitable for your application, calculate cutting data and generate a CNC program for a variety of controls.



The software is available at our web site and on a CD-ROM.

Example of Thread Milling CNC Program for Internal Threading

Right hand thread (climb milling) from bottom up.

Program is based on tool center.

This method of programming needs no tool radius compensation value other than an offset for wear.

$$A = \frac{D_o - D}{2}$$

A = Radius of tool path
 D_o = Major thread dia.
 D = Cutting dia.

General Program

```
G90 G00 G54 G43 H1X0 Y0 Z10 S---
G00 Z- ( TO THREAD DEPTH )
G01 G91 G41 D1 X(A/2) Y-(A/2) Z0 F--
G03 X(A/2) Y(A/2) R(A/2) Z(1/8 PITCH)
G03 X0 Y0 I-(A) J0 Z(PITCH)
G03 X-(A/2) Y(A/2) R(A/2) Z(1/8 PITCH)
G01 G40 X-(A/2) Y-(A/2) Z0
G90 X0 Y0 Z0
```

Internal Thread

EXAMPLE : M 32 X 2.0 (Thread depth 18 mm)
 TOOLHOLDER : SR0021 H21 (Cutting dia. 21 mm)
 INSERT: 21 I 2.0 ISO
 A = (32-21)/2 = 5.5

```
G90 G00 G54 G43 H1X0 Y0 Z10 S2800
G00 Z-18
G01 G91 G41X 2.75 Y-2.75 Z0 F85 D1
G03 X2.75 Y2.75 R2.75 Z0.25
G03 X0 Y0 I-5.5 J0 Z2
G03 X-2.75 Y2.75 R2.75 Z0.25
G01 G40 X-2.75 Y-2.75 Z0
G90 G0 X0 Y0 Z0
```

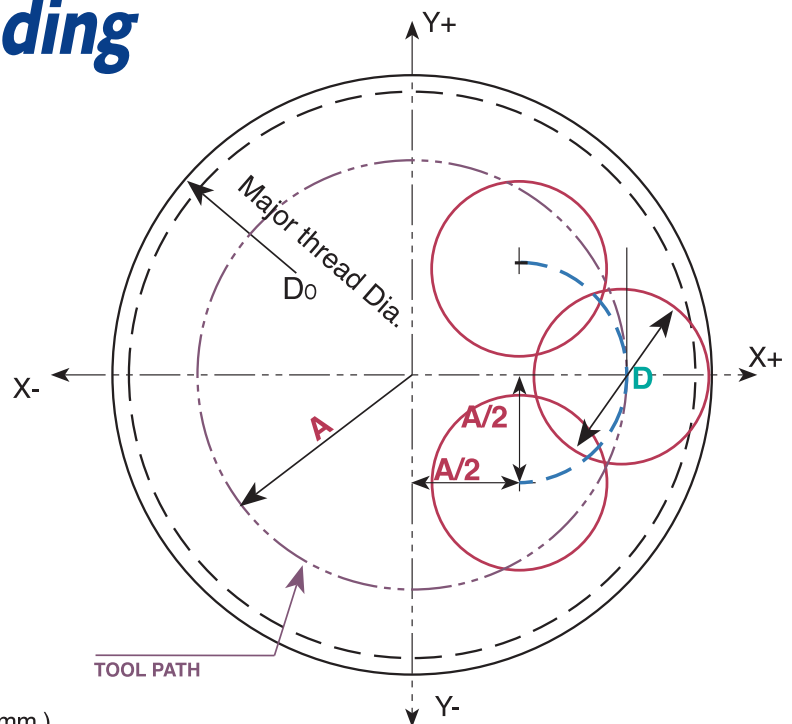

Mill-Thread Inserts Speed and Feed Selection

MT7 Sub-Micron Grade with Titanium Aluminum Nitride multi-layer coating (ISO K10 - K20). This is a general purpose grade, which can be used with all materials; it should be run at medium to high cutting speeds.

ISO	Materials	Cutting Speed m/min MT7
P	Low and Medium Carbon Steels	115-280
	High Carbon Steels	130-200
	Alloy Steels, Treated Steels	105-180
M	Stainless Steels	130-190
	Cast Steels	150-190
K	Cast Iron	80-170
N	Non- Ferrous and Aluminum	180-340
	Synthetics, Duroplastics, Thermoplastics	115-460
S	Nickel Alloys, Titanium Alloys	25- 90

Recommended FEED RATE : 0.05 - 0.15 mm

Spiral Mill-Thread Inserts Speed and Feed Selection

MT7 Sub-Micron Grade with Titanium Aluminum Nitride multi-layer coating (ISO K10 - K20). This is a general purpose grade, which can be used with all materials; it should be run at medium to high cutting speeds.

ISO	Materials	Cutting Speed m/min MT7
P	Low and Medium Carbon Steels	145-360
	High Carbon Steels	165-255
	Alloy Steels, Treated Steels	135-230
M	Stainless Steels	165-245
	Cast Steels	190-245
K	Cast Iron	100-220
N	Non- Ferrous and Aluminum	230-440
	Synthetics, Duroplastics, Thermoplastics	145-590
S	Nickel Alloys, Titanium Alloys	30-115

Recommended FEED RATE : 0.05 - 0.15 mm

As you may note, cutting speed is shown in range terms. In most standard cases choosing a speed in the middle of the range would be a good choice for a start.

For hard metals reduce cutting speed.

Spiral Finish Speed and Feed Selection

MT7 Sub-Micron Grade with Titanium Aluminum Nitride multi-layer coating (ISO K10 - K20). This is a general purpose grade, which can be used with all materials; it should be run at medium to high cutting speeds.

ISO	Materials	Cutting Speed m/min
P	Low and Medium Carbon Steels	200-330
	High Carbon Steels	170-235
	Alloy Steels, Treated Steels	100-195
M	Stainless Steels	180-230
	Cast Steels	180-230
K	Cast Iron	200-350
N	Non- Ferrous and Aluminum	500-1100
	Synthetics, Duroplastics, Thermoplastics	400-1500
S	Nickel Alloys, Titanium Alloys	30-55

Cutting Data

D-Thread type

MT7 Sub-Micron Grade with Titanium Aluminum Nitride multi-layer coating (ISO K10 - K20). This is a general purpose grade, which can be used with all materials; it should be run at medium to high cutting speeds.

ISO Standard	Material	Cutting Speed m/min
P	Low and Medium Carbon Steels <0.55%C	100-205
	High Carbon Steels ≥0.55%C	100-180
	Alloy Steels, Treated Steels	100-140
M	Stainless Steels - Free Cutting	85-125
	Stainless Steels - Austenitic	80-115
	Cast Steels	115-155
K	Cast Iron	75-145
N	Aluminium ≤12%Si, Copper	150-300
	Aluminium >12% Si	150-300
	Synthetics, Duroplastics, Thermoplastics	100-350
S	Nickel Alloys, Titanium Alloys	45-95

Recommended FEED RATE : 0.07 - 0.15 mm

Cutting Data

CMT type

MT7 Sub-Micron Grade with Titanium Aluminum Nitride multi-layer coating (ISO K10 - K20). This is a general purpose grade, which can be used with all materials; it should be run at medium to high cutting speeds.

ISO Standard	Material	Cutting Speed m/min	Feed mm/tooth			
			Ø10	Ø12	Ø18	Ø25
P	Low and Medium Carbon Steels <0.55%C	60-120	0.16	0.17	0.20	0.22
	High Carbon Steels ≥0.55%C	60-90	0.14	0.16	0.20	0.22
	Alloy Steels, Treated Steels	50-80	0.10	0.12	0.16	0.18
M	Stainless Steels - Free Cutting	70-100	0.10	0.11	0.15	0.17
	Stainless Steels - Austenitic	60-90	0.10	0.11	0.15	0.17
	Cast Steels	70-90	0.10	0.12	0.16	0.18
K	Cast Iron	40-80	0.16	0.17	0.20	0.22
N	Aluminium ≤12%Si, Copper	100-200	0.16	0.17	0.20	0.22
	Aluminium >12% Si	60-140	0.10	0.11	0.16	0.18
	Synthetics, Duroplastics, Thermoplastics	50-200	0.19	0.19	0.22	0.24
S	Nickel Alloys, Titanium Alloys	20-40	0.07	0.07	0.10	0.12
H	Hardened Steel 45 - 50HRc	60-70	0.09	0.09	0.13	0.15
	Hardened Steel 50 - 55HRc	50-60	0.08	0.08	0.12	0.14

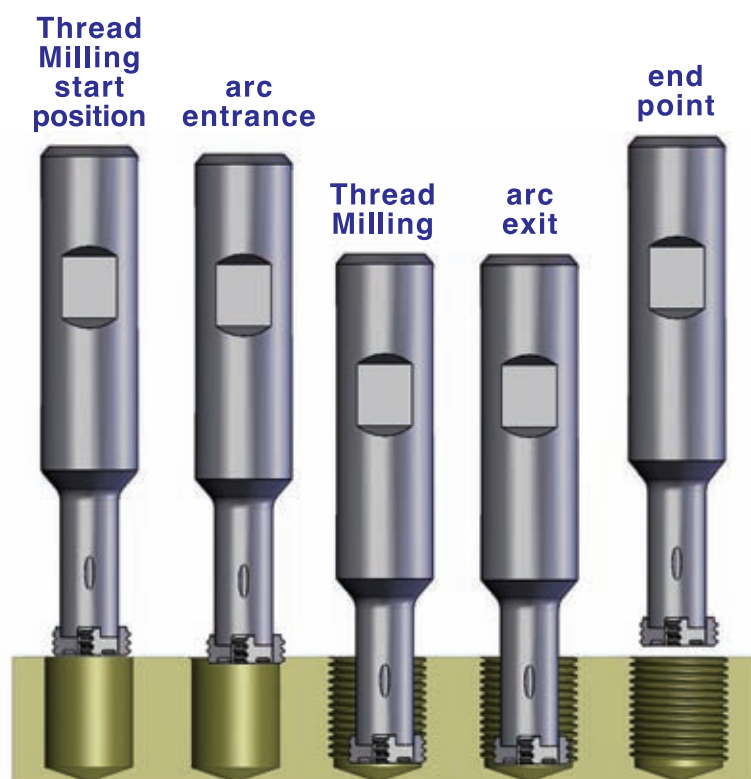

Mill-Thread Solid Carbide Grades, Speed and Feed Selection

DMT type

MT7 Sub-Micron Grade with Titanium Aluminum Nitride multi-layer coating (ISO K10 - K20). This is a general purpose grade, which can be used with all materials; it should be run at medium to high cutting speeds.

ISO	Material	Cutting Speed m/min	Feed mm/tooth							
			Ø3	Ø4	Ø5	Ø6	Ø8	Ø9	Ø10	Ø12
P	Low and Medium Carbon Steels <0.55%C	60-120	0.02	0.03	0.03	0.04	0.05	0.05	0.05	0.05
	High Carbon Steels ≥0.55%C	60-90	0.015	0.02	0.03	0.03	0.04	0.04	0.04	0.05
	Alloy Steels, Treated Steels	50- 80	0.015	0.02	0.02	0.02	0.02	0.03	0.03	0.04
M	Stainless Steels - Free Cutting	70-100	0.015	0.02	0.02	0.02	0.02	0.03	0.03	0.03
	Stainless Steels - Austenitic	60-90	0.015	0.02	0.02	0.02	0.02	0.03	0.03	0.03
	Cast Steels	70-90	0.015	0.02	0.02	0.02	0.02	0.03	0.03	0.04
K	Cast Iron	40-80	0.02	0.03	0.03	0.04	0.05	0.05	0.05	0.05
N	Aluminium ≤12%Si, Copper	100-200	0.02	0.03	0.03	0.04	0.05	0.05	0.05	0.05
	Aluminium >12% Si	60-140	0.015	0.02	0.02	0.02	0.02	0.03	0.03	0.03
	Synthetics, Duroplastics, Thermoplastics	50-200	0.03	0.04	0.05	0.05	0.06	0.06	0.06	0.06

MT, MTB, MTZ, EMT Types

MT7 Sub-Micron Grade with Titanium Aluminum Nitride multi-layer coating (ISO K10 - K20). This is a general purpose grade, which can be used with all materials; it should be run at medium to high cutting speeds.

ISO	Material	Cutting Speed m/min	Feed mm/tooth										
			Ø2	Ø3	Ø4	Ø6	Ø8	Ø10	Ø12	Ø14	Ø16	Ø20	Ø25
P	Low and Medium Carbon Steels <0.55%C	100-250	0.03	0.04	0.04	0.06	0.07	0.08	0.09	0.11	0.12	0.15	0.18
	High Carbon Steels ≥0.55%C	110-180	0.02	0.03	0.03	0.05	0.06	0.07	0.08	0.09	0.10	0.12	0.15
	Alloy Steels, Treated Steels	90-160	0.02	0.02	0.03	0.03	0.04	0.05	0.05	0.06	0.07	0.08	0.10
M	Stainless Steels - Free Cutting	60-160	0.02	0.03	0.03	0.04	0.05	0.06	0.06	0.07	0.08	0.09	0.11
	Stainless Steels - Austenitic	60-120	0.02	0.02	0.03	0.03	0.04	0.05	0.05	0.06	0.07	0.08	0.10
	Cast Steels	130-170	0.02	0.02	0.03	0.03	0.04	0.05	0.05	0.06	0.07	0.08	0.10
K	Cast Iron	70-150	0.03	0.04	0.04	0.06	0.07	0.08	0.09	0.11	0.12	0.15	0.18
N	Aluminium ≤12%Si, Copper	150-350	0.03	0.04	0.04	0.06	0.07	0.08	0.09	0.11	0.12	0.15	0.18
	Aluminium >12% Si	100-250	0.02	0.02	0.03	0.03	0.04	0.05	0.05	0.06	0.07	0.08	0.10
	Synthetics, Duroplastics,	100-400	0.05	0.06	0.07	0.08	0.10	0.11	0.12	0.13	0.15	0.18	0.22
S	Thermoplastics and Nickel Alloys, Titanium Alloys	20- 80	0.02	0.02	0.02	0.03	0.03	0.03	0.03	0.04	0.04	0.04	0.05

For cutters with long cutting length reduce feed rate by 40%

MTQ type

MT7 Sub-Micron Grade with Titanium Aluminum Nitride multi-layer coating (ISO K10 - K20). This is a general purpose grade, which can be used with all materials; it should be run at medium to high cutting speeds.

ISO	Material	Cutting Speed m/min	Feed mm/tooth					
			Ø10	Ø12	Ø14	Ø16	Ø20	Ø25
P	Low and Medium Carbon Steels <0.55%C	100-250	0.06	0.07	0.07	0.08	0.10	0.12
	High Carbon Steels ≥0.55%C	110-180	0.05	0.05	0.06	0.07	0.09	0.10
	Alloy Steels, Treated Steels	90-160	0.03	0.04	0.04	0.05	0.06	0.07
M	Stainless Steels - Free Cutting	60-160	0.04	0.04	0.05	0.06	0.06	0.08
	Stainless Steels - Austenitic	60- 120	0.04	0.04	0.04	0.05	0.06	0.07
	Cast Steels	130-170	0.03	0.04	0.04	0.05	0.06	0.07
K	Cast Iron	70-150	0.06	0.07	0.07	0.08	0.10	0.12
N	Aluminium ≤12%Si, Copper	150-350	0.06	0.07	0.07	0.08	0.10	0.12
	Aluminium >12% Si	100-250	0.03	0.04	0.04	0.05	0.06	0.07
	Synthetics, Duoplastics, Thermoplastics	100-400	0.08	0.09	0.10	0.11	0.13	0.15
S	Nickel Alloys, Titanium Alloys	20- 80	0.02	0.02	0.02	0.03	0.03	0.03

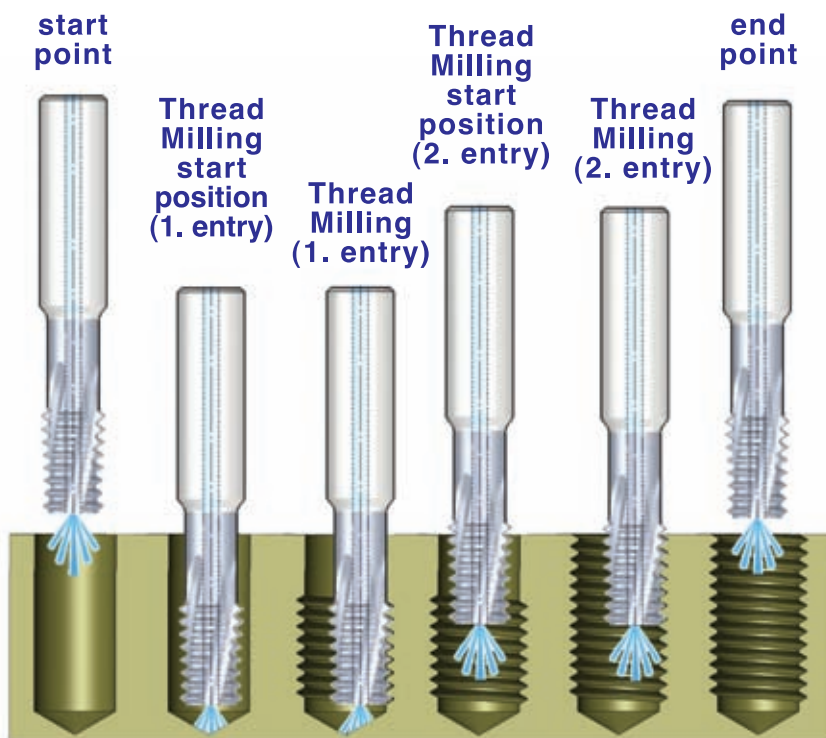

Mini Mill-Thread MTS and MTI types

MT7 Sub-Micron Grade with Titanium Aluminum Nitride multi-layer coating (ISO K10 - K20). This is a general purpose grade, which can be used with all materials; it should be run at medium to high cutting speeds.

MT8 Sub-Micron Grade with Aluminium Titanium Nitride (AlTiN) multi-layer coating (ISO K10-K20). Extremely high heat resistant and smooth cutting operation, for high performance, and normal machining conditions. General purpose for all materials.

MT11 Ultra-fine sub-micron grade with advanced PVD triple coating.

ISO Standard	Material	Cutting Speed m/min	Feed mm/tooth													
			Cutting Diameter = D													
			ø1	ø1.5	ø2	ø3	ø4	ø5	ø6	ø7	ø8	ø9	ø10	ø12	ø14	ø16
P	Low & Medium Carbon Steels < 0.55%C	60-120	0.04	0.05	0.05	0.07	0.09	0.11	0.13	0.14	0.15	0.16	0.16	0.17	0.18	0.18
	High Carbon Steels ≥ 0.55%C	60-90	0.03	0.04	0.05	0.06	0.08	0.09	0.10	0.12	0.13	0.14	0.14	0.16	0.17	0.18
	Alloy Steels, Treated Steels	50-80	0.03	0.04	0.04	0.05	0.05	0.06	0.07	0.07	0.08	0.09	0.10	0.12	0.13	0.14
M	Stainless Steels - Free Cutting	70-100	0.02	0.03	0.03	0.04	0.05	0.06	0.06	0.07	0.08	0.09	0.10	0.11	0.12	0.13
	Stainless Steel-Austenitic	60-90	0.02	0.03	0.03	0.04	0.05	0.06	0.06	0.07	0.08	0.09	0.10	0.11	0.12	0.13
	Cast Steels	70-90	0.03	0.04	0.04	0.05	0.05	0.06	0.07	0.07	0.08	0.09	0.10	0.12	0.13	0.14
K	Cast Iron	40-80	0.04	0.05	0.05	0.07	0.09	0.11	0.13	0.14	0.15	0.16	0.16	0.17	0.18	0.18
N	Aluminium ≤12%Si, Copper	100-200	0.04	0.05	0.05	0.07	0.09	0.11	0.13	0.14	0.15	0.16	0.16	0.17	0.18	0.18
	Aluminium >12%Si	60-140	0.03	0.03	0.03	0.04	0.05	0.06	0.06	0.07	0.08	0.09	0.10	0.11	0.13	0.14
	Synthetics, Duroplastics, Thermoplastics	50-200	0.09	0.10	0.11	0.12	0.14	0.16	0.18	0.19	0.19	0.19	0.19	0.19	0.20	0.20
S	Nickel Alloys and Titanium Alloys	20-40	0.03	0.03	0.03	0.04	0.04	0.05	0.06	0.06	0.06	0.07	0.07	0.07	0.08	0.08

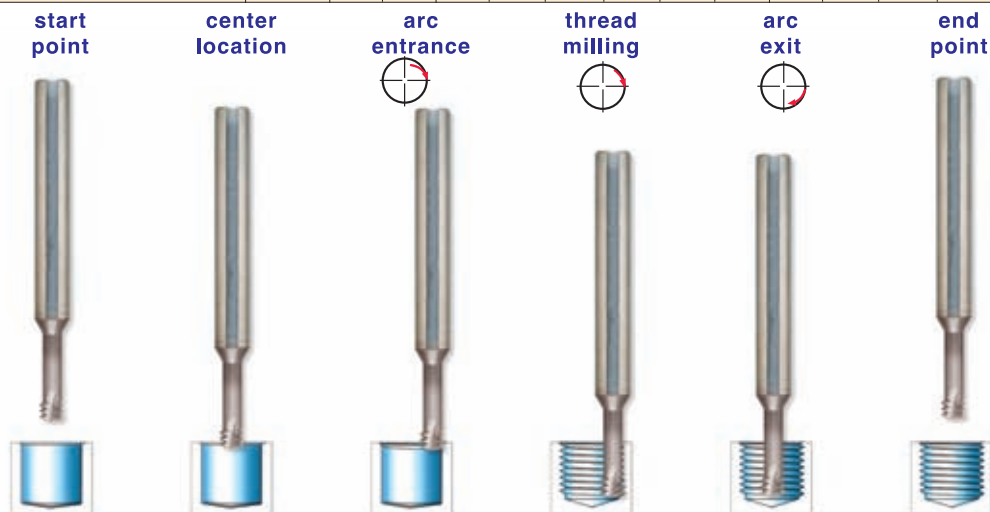

Mini Mill-Thread vs. Taps

Features	Mini Mill-Thread	Taps
Thread surface quality	High	Medium
Thread geometry	Very accurate	Medium
Thread tolerances	4H, 5H, 6H with std cutter	6H with standard tap, 4H with specific tap
Machining time	Same as tap or shorter	Short
Tool breakage	Almost not possible	Could happen often
Machining load	Very low	High
Range of thread diameters	Wide range of diameters	Specific tap for each diameter
Right/Left hand threading	Same cutter	Specific tap for each
Geometric shape	Full profile	Partial profile

Mini Mill-Thread MTSH type

MT9 Sub-Micron Grade with advanced PVD triple coating.

Left hand cutting for CNC code use **M04**

ISO	Material	Hardness HRc	Cutting Speed m/min	Feed mm/tooth													
				Cutting Diameter = D													
				ø1	ø1.5	ø2	ø3	ø4	ø5	ø6	ø7	ø8	ø9	ø10	ø12	ø14	ø16
S	Nickel Alloys, Titanium Alloys and High Temp. Alloys		20-40	0.03	0.03	0.03	0.04	0.04	0.05	0.06	0.06	0.06	0.07	0.07	0.07	0.08	0.08
H	Hardened Steels	45-50	60-70	0.03	0.04	0.04	0.05	0.05	0.06	0.06	0.07	0.07	0.08	0.08	0.09	0.10	0.11
		51-55	50-60	0.02	0.03	0.03	0.04	0.04	0.05	0.05	0.06	0.06	0.07	0.07	0.08	0.09	0.10
		56-62	40-50	0.01	0.02	0.02	0.03	0.03	0.04	0.04	0.05	0.05	0.06	0.06	0.07	0.08	0.09

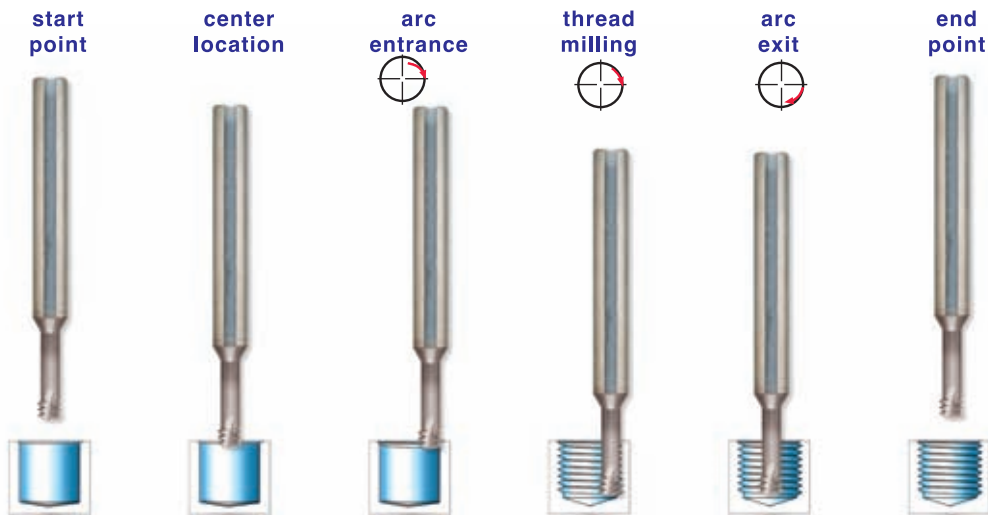

Case Study

Application	Internal Thread M4 X 0.7
Thread Depth	8.0 mm
Workpiece Material	Tool Steel: D2
Hardness	60-62 (HRc)
Cutter Description	MTSH0250C35 0.7 ISO
Machining Conditions	Cutting Speed: 44 m / min Feed: 0.03 mm / tooth
Machine	Mori Seiki VN5000
Control	Fanuc
Cooling Lubricant	Emulsion
Tool Life (No. of Threads)	84

MTH type

MT11 Sub-Micron Grade with advanced PVD triple blue coating.

ISO Standard	Material	Hardness HRc	Cutting Speed m/min	Feed mm/tooth Cutting Diameter = D								
				Ø2.5	Ø3	Ø4	Ø5	Ø6	Ø7	Ø8	Ø9	Ø10
S	Nickel Alloys, Titanium Alloys, High Temperature Alloys		20 - 50	0.02	0.02	0.02	0.02	0.03	0.03	0.03	0.03	0.04
H	Hardened Steels, Cast Iron	45 - 50	70 - 80	0.02	0.03	0.03	0.04	0.04	0.05	0.05	0.06	0.07
		51 - 55	60 - 70	0.01	0.02	0.02	0.03	0.03	0.04	0.04	0.05	0.06
		56 - 62	40 - 50	0.005	0.01	0.01	0.02	0.02	0.03	0.03	0.04	0.05

For cutters with long cutting length reduce feed rate by 40%

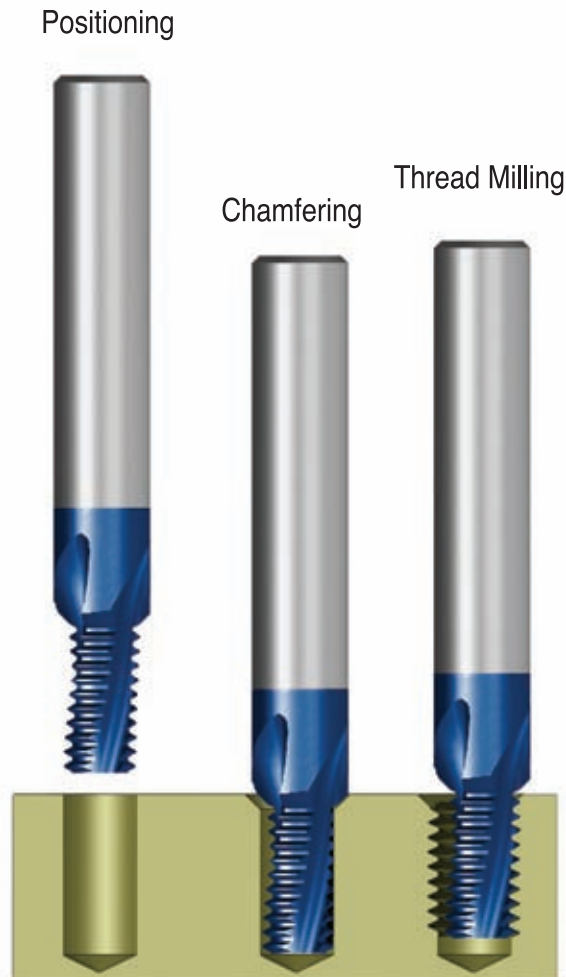



Solid Carbide Milling Tools

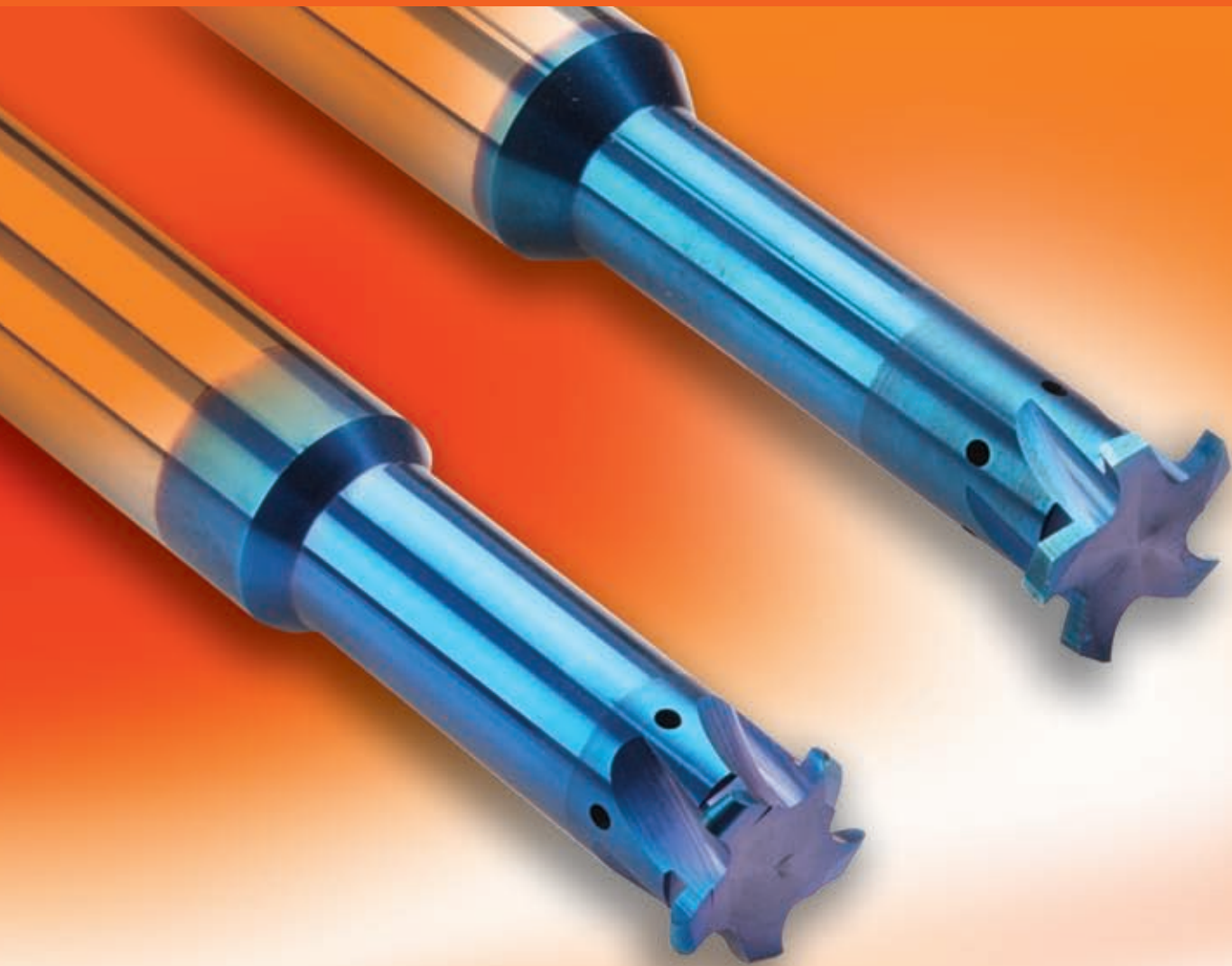

For Grooving Deep Parts

Advantages

Carbide grade: MT8 Sub-micron grade with advanced PVD triple coating (ISO K10-K20). Extremely high heat resistant and smooth cutting operation, for high performance, and normal machining conditions. General purpose for all materials.

- Enables machining in deep holes
- Coolant through the flutes is very effective for deep holes.
- Spiral flutes allow smooth cutting action.
- Longer tool life due to special multi-layer coating.
- Shorter machining time due to multi, 3 to 5, flutes.

Contents:

Page:

Product Identification	158
Groove Milling with internal coolant through the flutes	159
Full Radius Groove Milling with internal coolant through the flutes	159

Product Identification

Groove Milling Ordering Codes

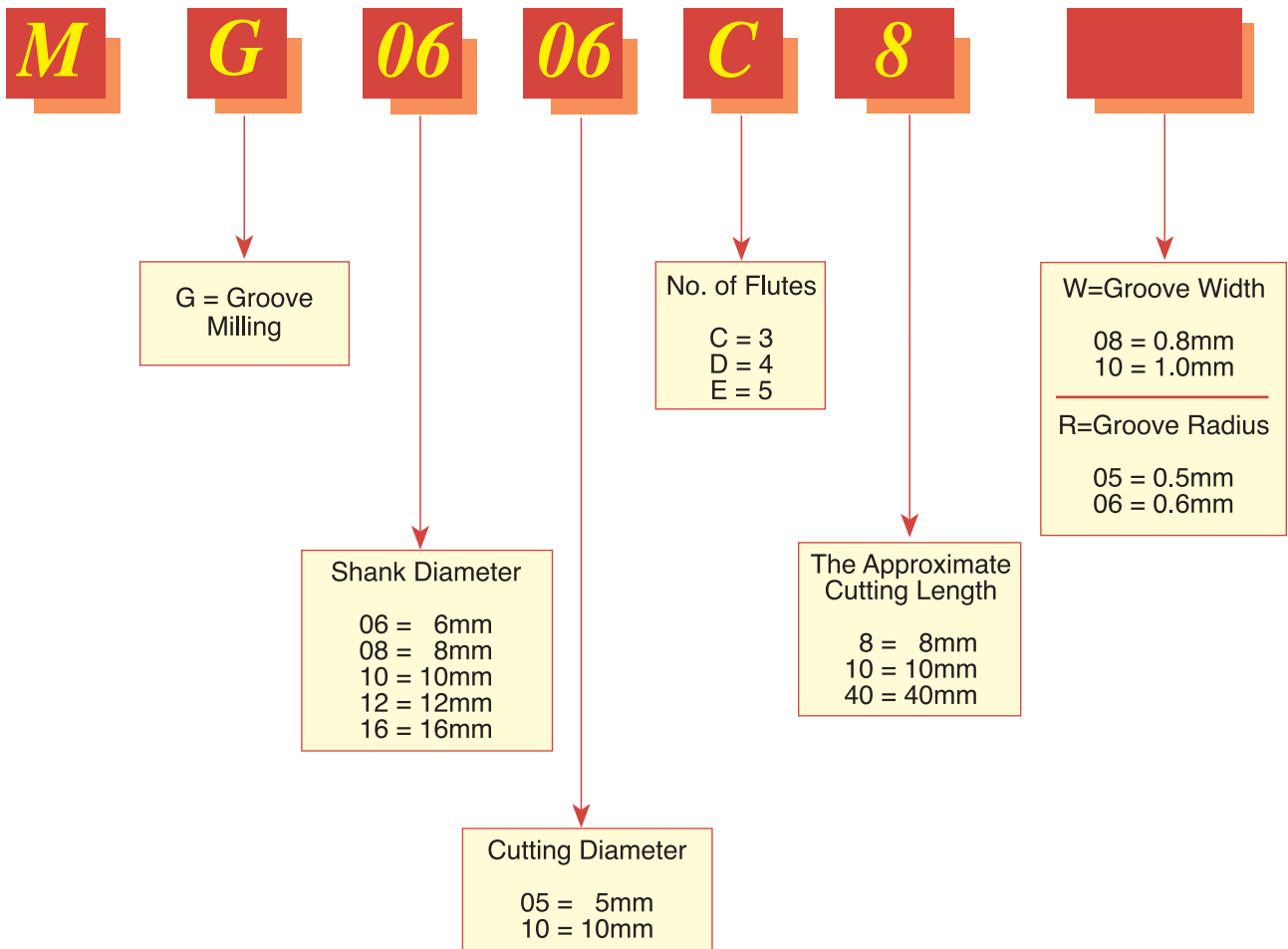

Groove Milling

with internal coolant through the flutes
Same Tool for Internal and External Grooving

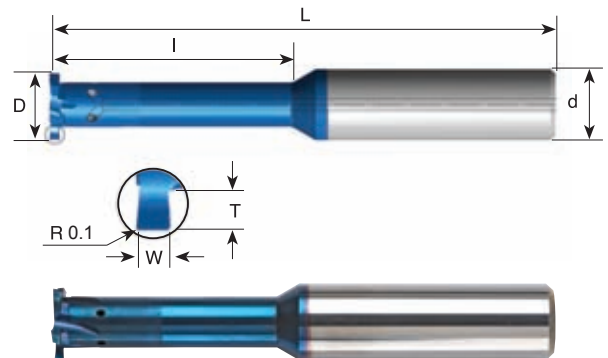

For grooving deep parts

W ± 0.02	T Max.	Groove Dia. (min.)	Ordering Code	d	D	No. of Flutes	I	L
0.80	0.8	$\phi > 6$	MG0606C8 W08	6	6.0	3	8	58
1.00	1.2	$\phi \geq 8$	MG08078D10 W10	8	7.8	4	10	64
1.20	1.4	$\phi \geq 10$	MG10098D20 W12	10	9.8	4	20	73
1.40	1.8	$\phi > 16$	MG1616E30 W14	16	16.0	5	30	101
1.70	2.0	$\phi > 16$	MG1616E40 W17	16	16.0	5	40	101
1.95	2.2	$\phi > 16$	MG1616E45 W19	16	16.0	5	45	101

Order example: MG 10098D20 W12 MT8

Full Radius Groove Milling

with internal coolant through the flutes
Same Tool for Internal and External Grooving

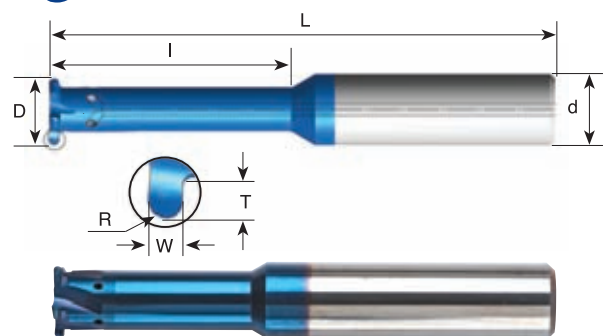

For grooving deep parts

R	W ± 0.02	T Max.	Groove Dia. (min.)	Ordering Code	d	D	No. of Flutes	I	L
0.5	1.00	0.8	$\phi > 6$	MG0606C8 R05	6	6.0	3	8	58
0.5	1.00	1.0	$\phi > 8.8$	MG10088D16 R05	10	8.8	4	16	73
0.6	1.20	1.0	$\phi > 10$	MG1010D20 R06	10	10.0	4	20	73
0.9	1.80	1.4	$\phi > 12$	MG1212D30 R09	12	12.0	4	30	84
1.0	2.00	1.6	$\phi > 16$	MG1616E40 R10	16	16.0	5	40	101
1.5	3.00	2.2	$\phi > 16$	MG1616E40 R15	16	16.0	5	40	101

Order example: MG 1010D20 R06 MT8

Mini Chamfer



Advantages

Carbide grade: MT8 Sub-micron grade with advanced PVD triple coating (ISO K10-K20). Extremely high heat resistant and smooth cutting operation, for high performance, and normal machining conditions. General purpose for all materials.

- Optimal for deburring, back chamfering and grooving.
- Double side cutting.
- Spiral flute allows smooth cutting action.

Contents:

Page:

Product Identification	162
Mini Chamfer	163-164
Mini Chamfer Kit	164
Special Solid Carbide Tools	164

Product Identification

Mini Chamfer Ordering Codes

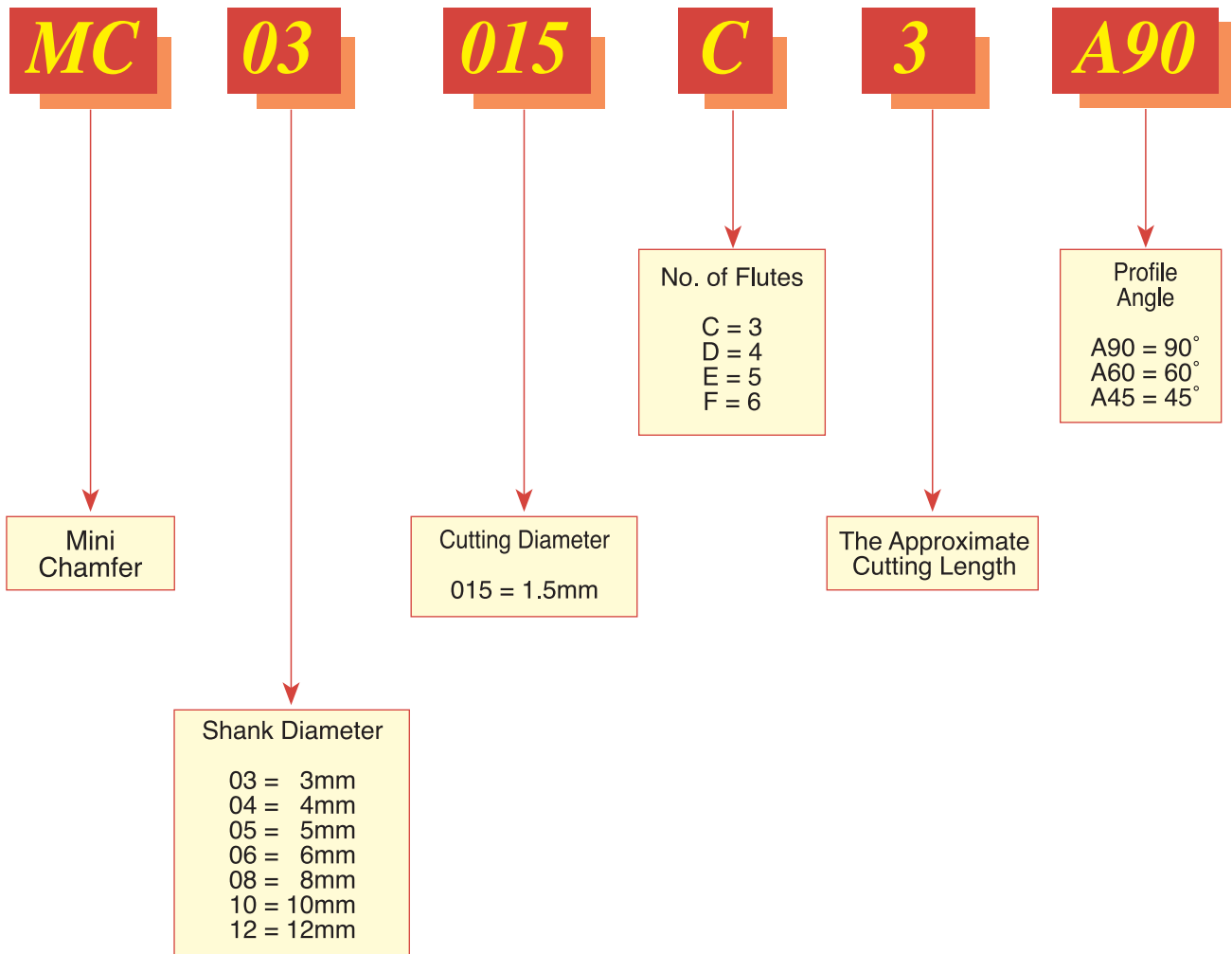

Mini Chamfer

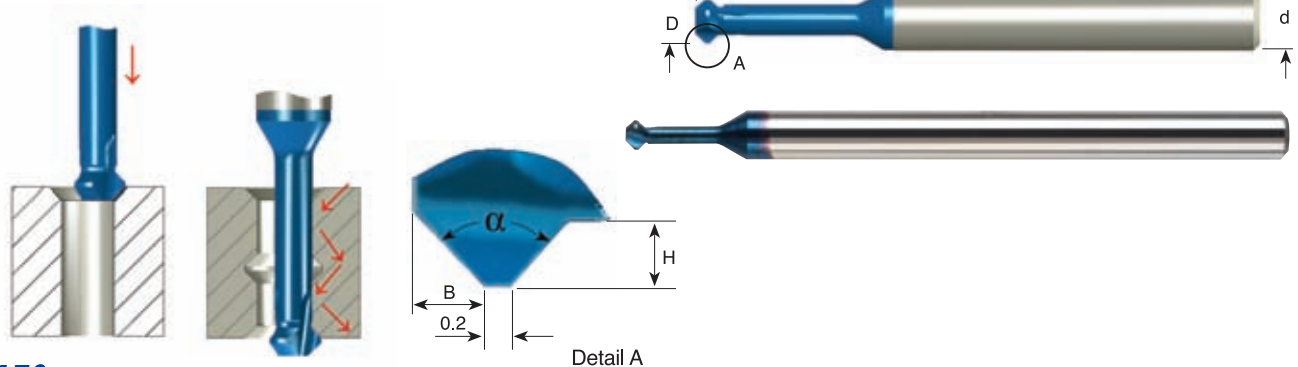

45°

Ordering Code	d	D	I	H	B	α	No. of Flutes	L
MC03015C3 A90	3	1.5	3.8	0.3	0.4	90°	3	39
MC0302C5 A90	3	2.0	5.0	0.4	0.5	90°	3	39
MC03025C6 A90	3	2.5	6.3	0.5	0.6	90°	3	39
MC0303C7 A90	3	3.0	7.5	0.6	0.7	90°	3	39
MC04035C9 A90	4	3.5	8.8	0.7	0.8	90°	3	51
MC0404C10 A90	4	4.0	10.0	0.8	0.9	90°	3	51
MC05045C11 A90	5	4.5	11.3	1.0	1.1	90°	3	51
MC0505C12 A90	5	5.0	12.5	1.1	1.2	90°	3	51
MC06055C13 A90	6	5.5	13.8	1.2	1.3	90°	3	51
MC0606C15 A90	6	6.0	15.0	1.5	1.6	90°	3	51

Long Reach 45°

Ordering Code	d	D	I	H	B	α	No. of Flutes	L
MC0303C12 A90	3	3.0	12.0	0.6	0.7	90°	3	39
MC04035C14 A90	4	3.5	14.0	0.7	0.8	90°	3	51
MC0404C16 A90	4	4.0	16.0	0.8	0.9	90°	3	51
MC05045C18 A90	5	4.5	18.0	1.0	1.1	90°	3	51
MC0505C20 A90	5	5.0	20.0	1.1	1.2	90°	3	51
MC06055C22 A90	6	5.5	22.0	1.2	1.3	90°	3	58
MC0606C24 A90	6	6.0	24.0	1.5	1.6	90°	3	58
MC0808D28 A90	8	8.0	28.0	1.6	1.7	90°	4	64
MC1010E35 A90	10	10.0	35.0	1.8	1.8	90°	5	73
MC1212F42 A90	12	12.0	42.0	2.1	2.2	90°	6	84

30°

Ordering Code	d	D	I	H	B	α	No. of Flutes	L
MC0302C5 A60	3	2.0	5.0	0.4	0.3	60°	3	39
MC0303C7 A60	3	3.0	7.5	0.6	0.3	60°	3	39
MC04035C9 A60	4	3.5	8.8	0.7	0.5	60°	3	51
MC0404C10 A60	4	4.0	10.0	0.8	0.5	60°	3	51
MC05045C11 A60	5	4.5	11.3	1.0	0.6	60°	3	51
MC0505C12 A60	5	5.0	12.5	1.1	0.7	60°	3	51

Mini Chamfer

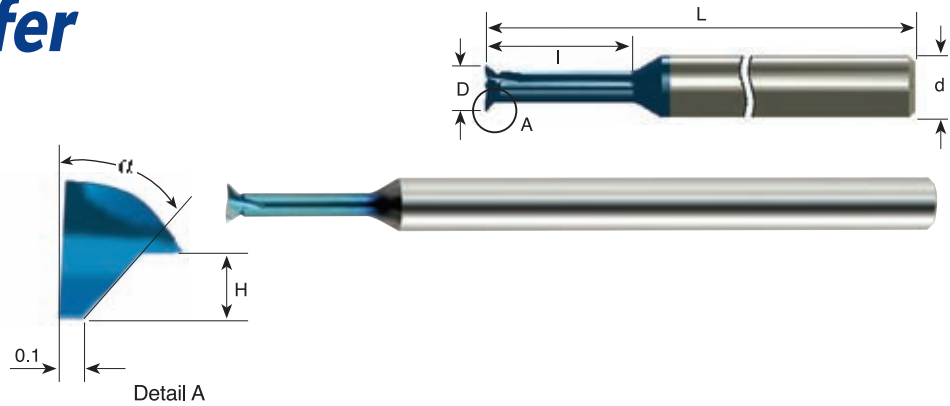
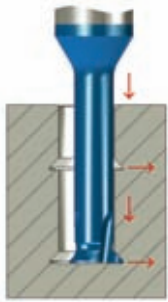

Dovetail 45° *

Ordering Code	d	D	I	H	α	No. of Flutes	L
MC03015C4 A45	3	1.5	4.5	0.3	45°	3	39
MC0302C6 A45	3	2.0	6.0	0.4	45°	3	39
MC03025C7 A45	3	2.5	7.5	0.5	45°	3	39
MC0303C12 A45	3	3.0	12.0	0.6	45°	3	39
MC04035C14 A45	4	3.5	14.0	0.7	45°	3	51
MC0404C16 A45	4	4.0	16.0	0.8	45°	3	51
MC05045C18 A45	5	4.5	18.0	1.0	45°	3	51
MC0505C20 A45	5	5.0	20.0	1.1	45°	3	51
MC06055C22 A45	6	5.5	22.0	1.2	45°	3	58
MC0606C24 A45	6	6.0	24.0	1.5	45°	3	58

* One cutting edge

Mini Chamfer Kit

Kit KMC	Qty
MC 0303 C12 A90	1
MC 03025 C6 A90	1
MC 0404 C10 A90	1
MC 04035 C9 A90	1
MC 05045 C11 A90	1
MC 0606 C24 A90	1



Special Solid Carbide Tools



As part of being a service-orientated company, Carmex produces specials according to customer's requirements. Special tools are supplied in short delivery times.



Turning Tools

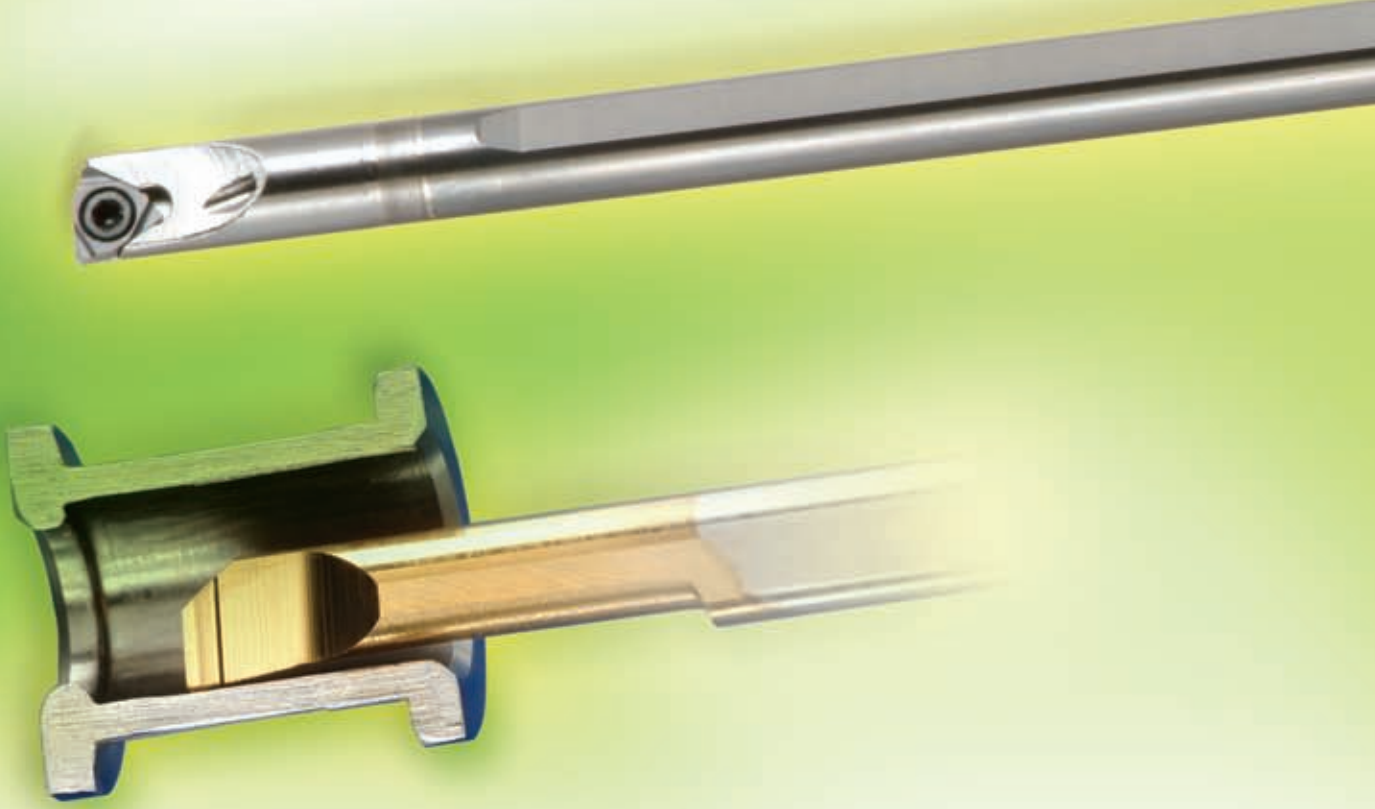

Contents: **Page:**

Carbide Shank Boring Bars and Inserts 166

Carbide Shank Boring Bars and Inserts

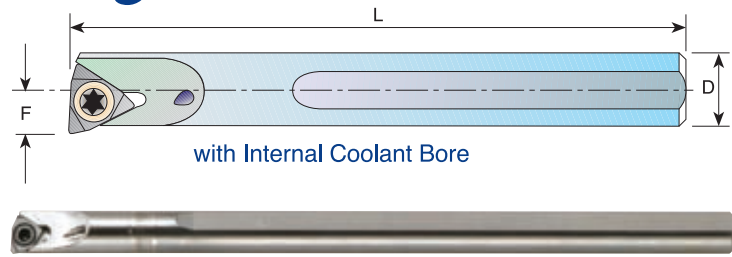

D	Ordering Code	L	F	Min. Bore Dia.	Screw	Key
6	SIR 0006 H06CT	100	3.3	6.5	S6	K6
8	SIR 0008 K06CT	125	4.3	8.6	S6	K6
10	SIR 0010 M06CT	150	5.3	10.6	S6	K6

Insert Ordering example: 06 IR TURN BMA
Nose radius R= 0.2mm

For turning small bores see pages 169-175

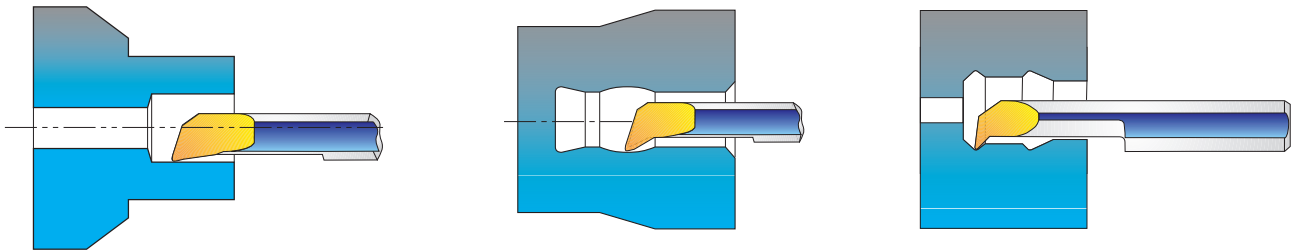

Tiny Tools

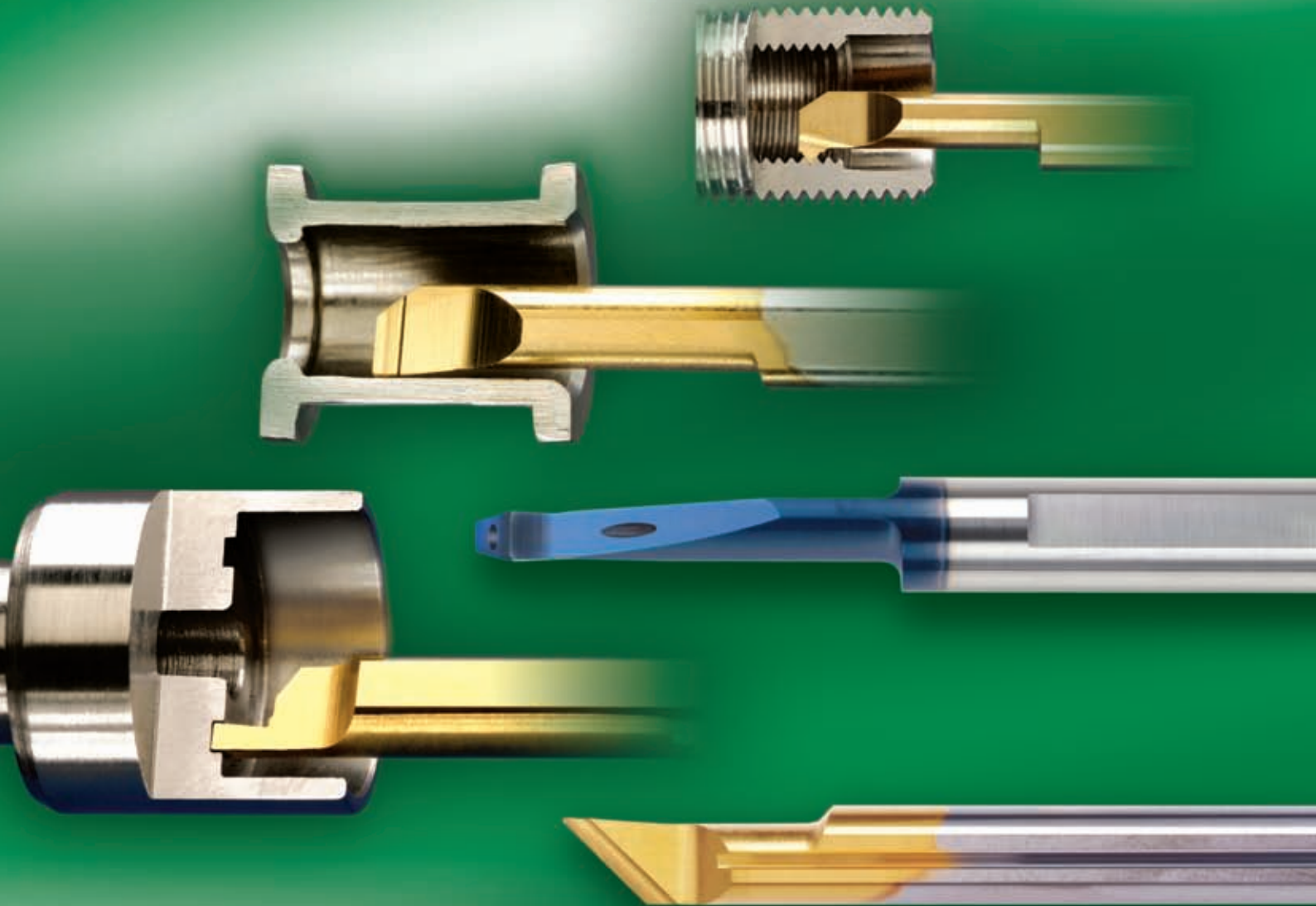

Solid Carbide tools for working in small bores

These tools are made for the high-tech, medical and small component industry. All tools include cooling channel on the shank, enabling the cooling fluid to reach efficiently the cutting edge, for easy chip removal and smooth cutting operations.

Contents:

Page:

Contents:

Page:

Product Identification	168	MGR Chamfering and Profiling Bars	183
MTR Boring Bars	169-170	MKR Grooving Bars	184
MXR Back Turning Bars	171	MFR Face Grooving Bars	185
MPR Profiling and Boring Bars	172-173	MFL Face Grooving Bars	186
MUR Profiling, 90° Face Cutting Bars	174	MVR Deep Face Grooving Bars	187
MQR Profiling and Boring Bars	175	MZR Face Grooving Bars	188
MIR Threading Bars	176-179	Tiny Tools Bar Holders	189-190
MDR Thread Relief, Chamfering and Grooving	180	Tiny Tools Kits	191
MCR Threading Bars	181	Technical Section	192
MWR Chamfering and Boring Bars	182		

Product Identification

Tiny Bars Ordering Codes

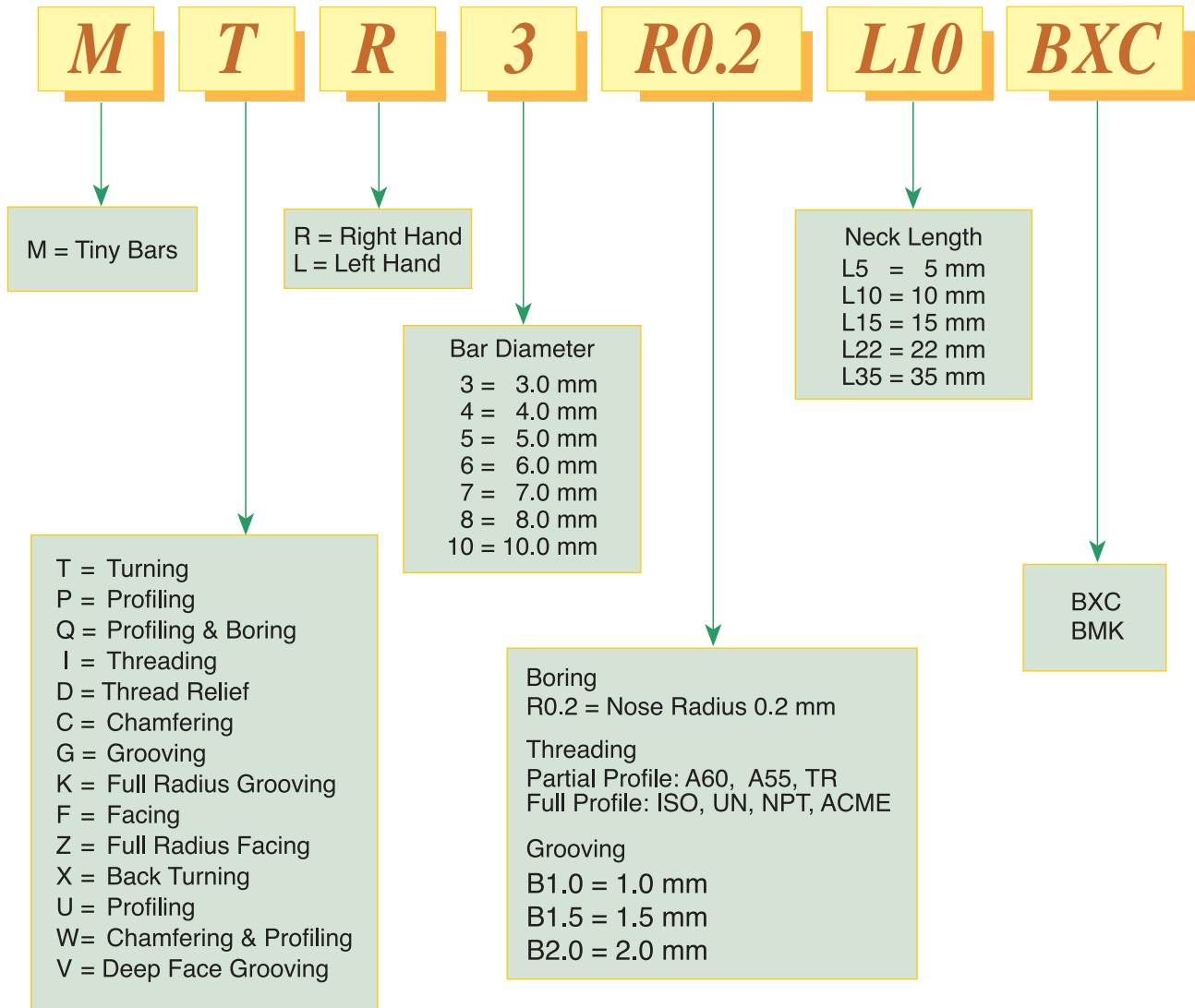

MTR Bars Boring - with Coolant Channel

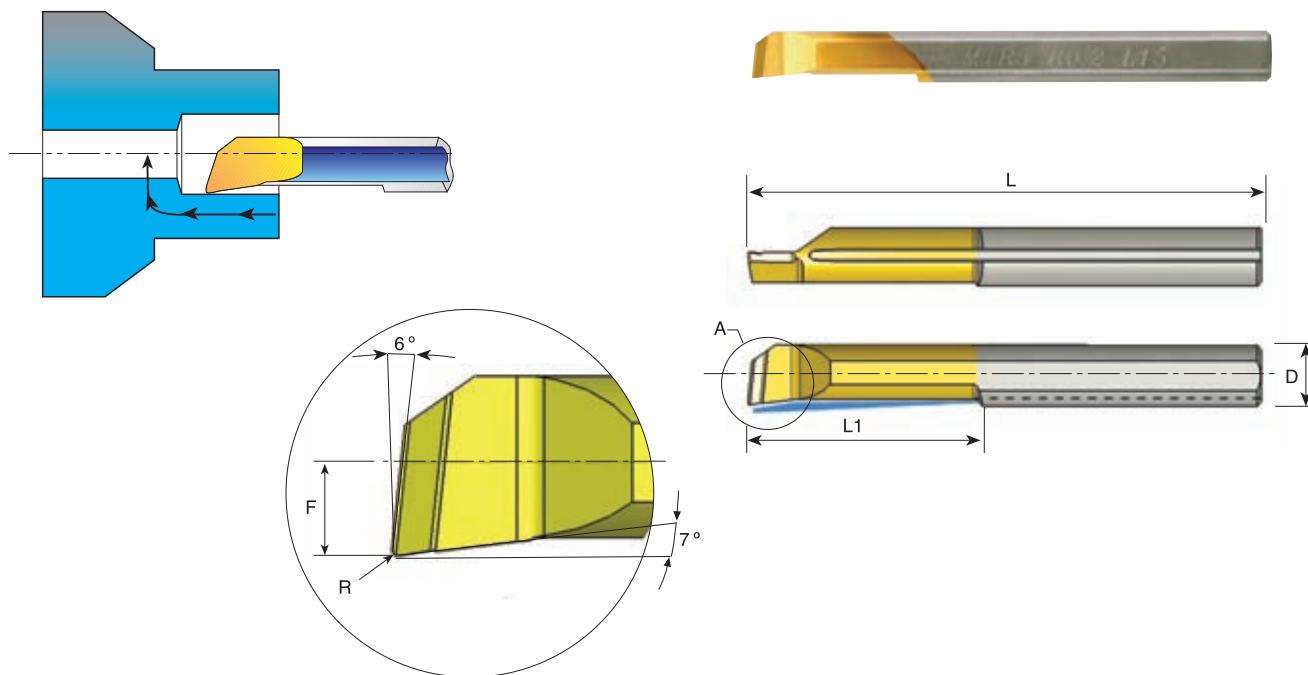

Detail A

D	Ordering Code	L	L1	R	F	Min. Bore Dia.	Holder*
3.0	* MTR 1 R0.05 L4	39	4	0.05	0.5	1.0	SIM 0020 H3
3.0	* MTR 1.5R0.1 L6	39	6	0.10	0.7	1.5	SIM 0020 H3
3.0	* MTR 2 R0.05 L10	39	10	0.05	0.8	2.1	SIM 0020 H3
3.0	* MTR 2 R0.15 L5	39	5	0.15	0.8	2.1	SIM 0020 H3
3.0	* MTR 2 R0.15 L10	39	10	0.15	0.8	2.1	SIM 0020 H3
3.0	MTR 3 R0.05 L10	39	10	0.05	1.3	3.1	SIM 0020 H3
3.0	MTR 3 R0.05 L15	39	15	0.05	1.3	3.1	SIM 0020 H3
3.0	MTR 3 R0.1 L15	39	15	0.10	1.3	3.1	SIM 0020 H3
3.0	MTR 3 R0.2 L10	39	10	0.20	1.3	3.1	SIM 0020 H3
3.0	MTR 3 R0.2 L15	39	15	0.20	1.3	3.1	SIM 0020 H3
4.0	MTR 4 R0.05 L15	51	15	0.05	1.7	4.1	SIM 0020 H4
4.0	MTR 4 R0.1 L10	51	10	0.10	1.7	4.1	SIM 0020 H4
4.0	MTR 4 R0.1 L15	51	15	0.10	1.7	4.1	SIM 0020 H4
4.0	MTR 4 R0.1 L22	51	22	0.10	1.7	4.1	SIM 0020 H4
4.0	MTR 4 R0.2 L10	51	10	0.20	1.7	4.1	SIM 0020 H4
4.0	MTR 4 R0.2 L15	51	15	0.20	1.7	4.1	SIM 0020 H4
4.0	MTR 4 R0.2 L22	51	22	0.20	1.7	4.1	SIM 0020 H4

* Without coolant



MTR Bars Boring - with Coolant Channel

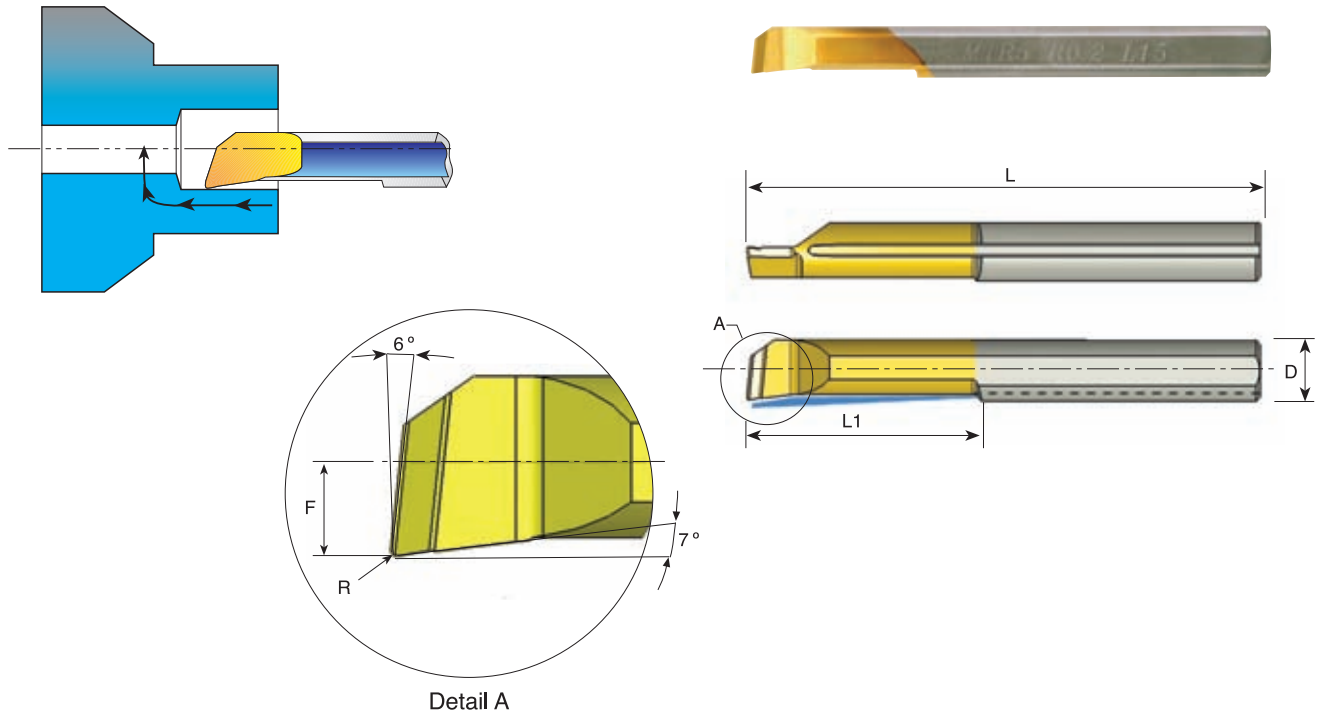

D	Ordering Code	L	L1	R	F	Min. Bore Dia.	Holder*
5.0	MTR 5 R0.05 L15	51	15	0.05	2.1	5.1	SIM 0020 H5
5.0	MTR 5 R0.1 L15	51	15	0.10	2.1	5.1	SIM 0020 H5
5.0	MTR 5 R0.1 L22	51	22	0.10	2.1	5.1	SIM 0020 H5
5.0	MTR 5 R0.1 L30	76	30	0.10	2.1	5.1	SIM 0020 H5
5.0	MTR 5 R0.2 L15	51	15	0.20	2.1	5.1	SIM 0020 H5
5.0	MTR 5 R0.2 L22	51	22	0.20	2.1	5.1	SIM 0020 H5
5.0	MTR 5 R0.2 L30	76	30	0.20	2.1	5.1	SIM 0020 H5
6.0	MTR 6 R0.05 L15	51	15	0.05	2.8	6.1	SIM 0020 H6
6.0	MTR 6 R0.1 L15	51	15	0.10	2.8	6.1	SIM 0020 H6
6.0	MTR 6 R0.2 L15	51	15	0.20	2.8	6.1	SIM 0020 H6
6.0	MTR 6 R0.2 L22	51	22	0.20	2.8	6.1	SIM 0020 H6
6.0	MTR 6 R0.2 L30	58	30	0.20	2.8	6.1	SIM 0020 H6
6.0	MTR 6 R0.2 L35	76	35	0.20	2.8	6.1	SIM 0020 H6
7.0	MTR 7 R0.2 L22	62	22	0.20	3.3	7.1	SIM 0020 H7
7.0	MTR 7 R0.2 L30	62	30	0.20	3.3	7.1	SIM 0020 H7
8.0	MTR 8 R0.2 L15	64	15	0.20	3.8	8.1	SIM 0020 H8
8.0	MTR 8 R0.2 L22	64	22	0.20	3.8	8.1	SIM 0020 H8
8.0	MTR 8 R0.2 L35	76	35	0.20	3.8	8.1	SIM 0020 H8
10.0	MTR10R0.2 L35	73	35	0.20	4.8	10.1	SIM 0020 H10

Order example: MTR 4 R0.2 L15 BXC

For L.H. bars specify **MTL** instead of **MTR**

* For additional holders see page 189-190

MXR Bars Back Turning - with Coolant Channel

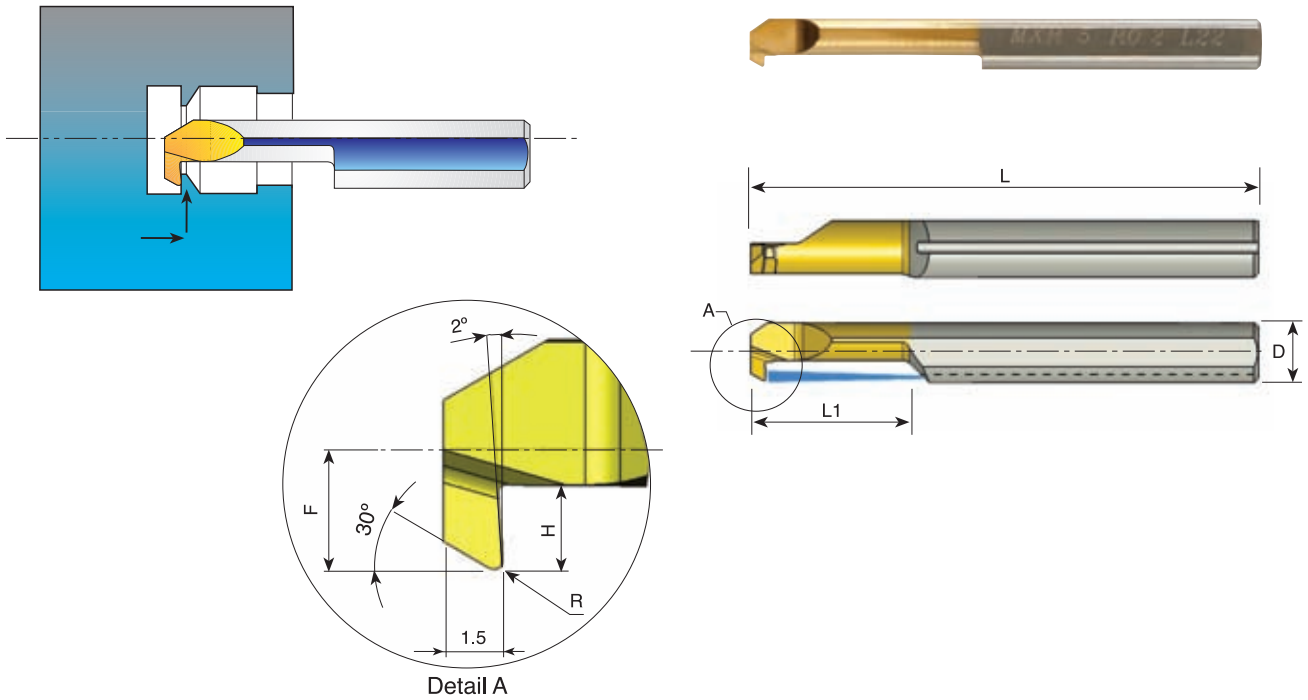

D	Ordering Code	L	L1	R	H	F	Min. Bore Dia.	Holder*
4.0	MXR 4 R0.1 L10	51	10	0.10	0.5	1.3	3.1	SIM 0020 H4
4.0	MXR 4 R0.15 L10	51	10	0.15	0.8	1.6	4.1	SIM 0020 H4
4.0	MXR 4 R0.15 L15	51	15	0.15	0.8	1.6	4.1	SIM 0020 H4
5.0	MXR 5 R0.2 L15	51	15	0.20	1.0	2.2	5.1	SIM 0020 H5
5.0	MXR 5 R0.2 L22	51	22	0.20	1.0	2.2	5.1	SIM 0020 H5
6.0	MXR 6 R0.2 L15	51	15	0.20	1.8	2.8	6.1	SIM 0020 H6
6.0	MXR 6 R0.2 L22	51	22	0.20	1.8	2.8	6.1	SIM 0020 H6

Order example: MXR 4 R0.15 L15 BXC

* For additional holders see page 189-190

MPR Bars Profiling and Boring - with Coolant Channel

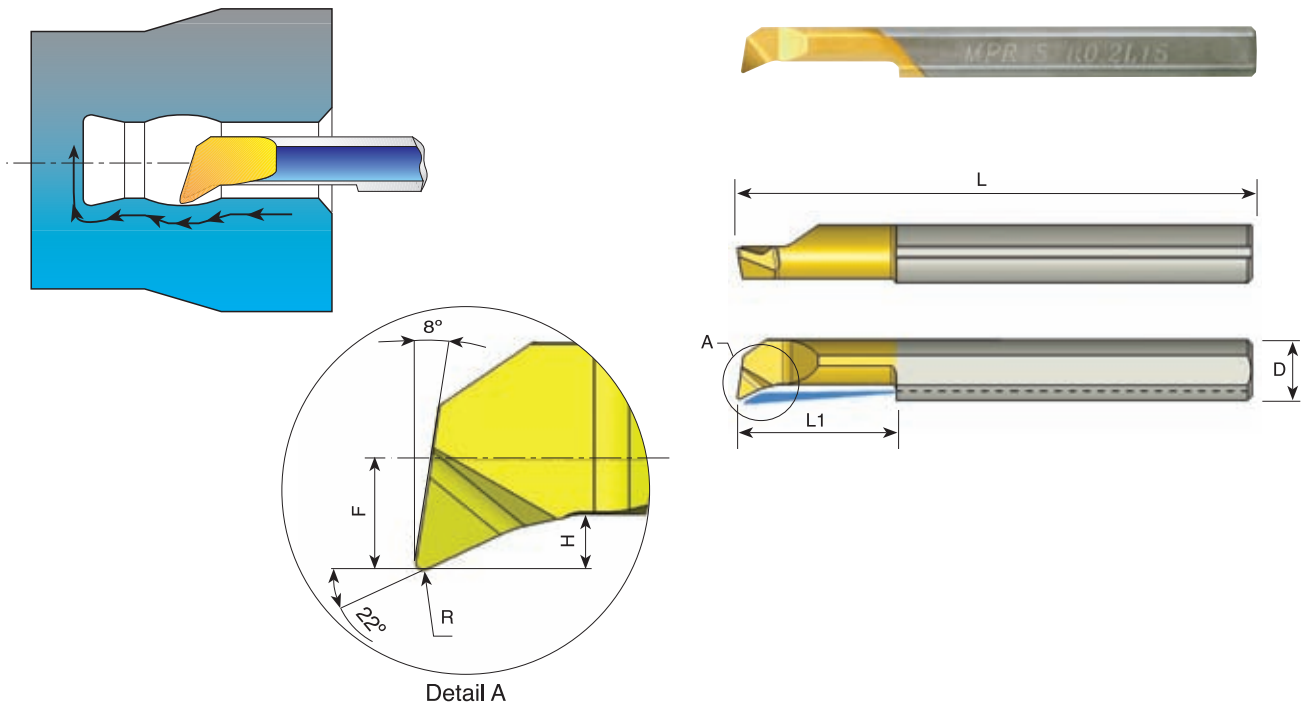

D	Ordering Code	L	L1	R	H	F	Min. Bore Dia.	Holder*
3.0	* MPR 1 R0.05 L4	39	4	0.05	0.2	0.5	1.0	SIM 0020 H3
3.0	* MPR 1.5R0.1L6	39	6	0.10	0.3	0.7	1.5	SIM 0020 H3
3.0	* MPR 2 R0.05 L10	39	10	0.05	0.5	0.8	2.1	SIM 0020 H3
3.0	* MPR 2 R0.1 L10	39	10	0.10	0.5	0.8	2.1	SIM 0020 H3
3.0	* MPR 2 R0.15 L5	39	5	0.15	0.5	0.8	2.1	SIM 0020 H3
3.0	* MPR 2 R0.15 L10	39	10	0.15	0.5	0.8	2.1	SIM 0020 H3
3.0	MPR 3 R0.05 L10	39	10	0.05	0.7	1.3	3.1	SIM 0020 H3
3.0	MPR 3 R0.05 L15	39	15	0.05	0.7	1.3	3.1	SIM 0020 H3
3.0	MPR 3 R0.1 L15	39	15	0.10	0.7	1.3	3.1	SIM 0020 H3
3.0	MPR 3 R0.1 L22	47	22	0.10	0.7	1.3	3.1	SIM 0020 H3
3.0	MPR 3 R0.2 L10	39	10	0.20	0.7	1.3	3.1	SIM 0020 H3
3.0	MPR 3 R0.2 L15	39	15	0.20	0.7	1.3	3.1	SIM 0020 H3
3.0	MPR 3 R0.2 L22	47	22	0.20	0.7	1.3	3.1	SIM 0020 H3
4.0	MPR 4 R0.1 L15	51	15	0.10	0.8	1.7	4.1	SIM 0020 H4
4.0	MPR 4 R0.1 L22	51	22	0.10	0.8	1.7	4.1	SIM 0020 H4
4.0	MPR 4 R0.2 L10	51	10	0.20	0.8	1.7	4.1	SIM 0020 H4
4.0	MPR 4 R0.2 L15	51	15	0.20	0.8	1.7	4.1	SIM 0020 H4
4.0	MPR 4 R0.2 L22	51	22	0.20	0.8	1.7	4.1	SIM 0020 H4

* Without coolant

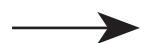

MPR Bars Profiling and Boring - with Coolant Channel

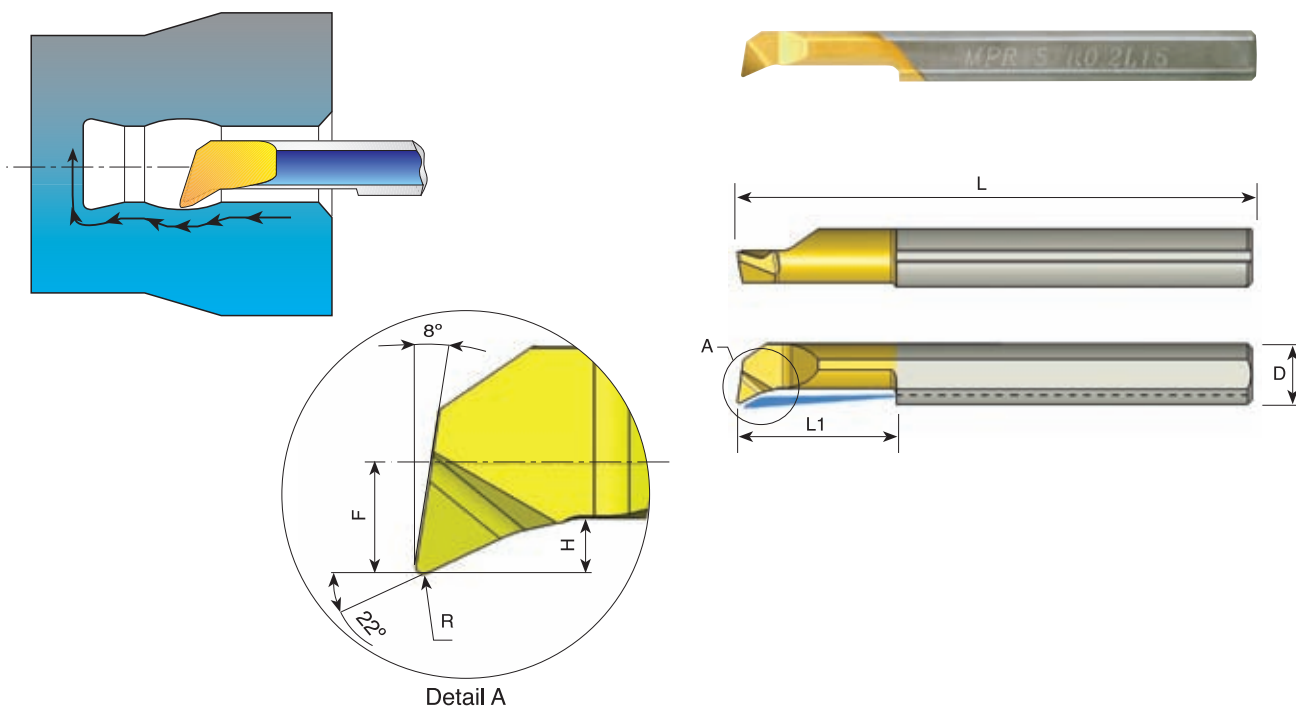

D	Ordering Code	L	L1	R	H	F	Min. Bore Dia.	Holder*
5.0	MPR 5 R0.1 L22	51	22	0.10	1.2	2.1	5.1	SIM 0020 H5
5.0	MPR 5 R0.1 L30	76	30	0.10	1.2	2.1	5.1	SIM 0020 H5
5.0	MPR 5R0.2 L15	51	15	0.20	1.2	2.1	5.1	SIM 0020 H5
5.0	MPR 5 R0.2 L22	51	22	0.20	1.2	2.1	5.1	SIM 0020 H5
5.0	MPR 5 R0.2 L30	76	30	0.20	1.2	2.1	5.1	SIM 0020 H5
6.0	MPR 6 R0.2 L15	51	15	0.20	1.4	2.8	6.1	SIM 0020 H6
6.0	MPR 6 R0.2 L22	51	22	0.20	1.4	2.8	6.1	SIM 0020 H6
6.0	MPR 6 R0.2 L30	76	30	0.20	1.4	2.8	6.1	SIM 0020 H6
7.0	MPR 7 R0.2 L22	62	22	0.20	1.5	3.3	7.1	SIM 0020 H7
7.0	MPR 7 R0.2 L30	62	30	0.20	1.5	3.3	7.1	SIM 0020 H7
8.0	MPR 8 R0.2 L15	64	15	0.20	1.6	3.8	8.1	SIM 0020 H8
8.0	MPR 8 R0.2 L22	64	22	0.20	1.6	3.8	8.1	SIM 0020 H8
8.0	MPR 8 R0.2 L35	76	35	0.20	1.6	3.8	8.1	SIM 0020 H8
10.0	MPR 10R0.2 L35	73	35	0.20	2.0	4.8	10.1	SIM 0020 H10

Order example: MPR 4 R0.2 L15 BXC

For L.H. bars specify MPL instead of MPR

* For additional holders see page 189-190

MUR Bars Profiling, 90° Face Cutting - with Coolant Channel

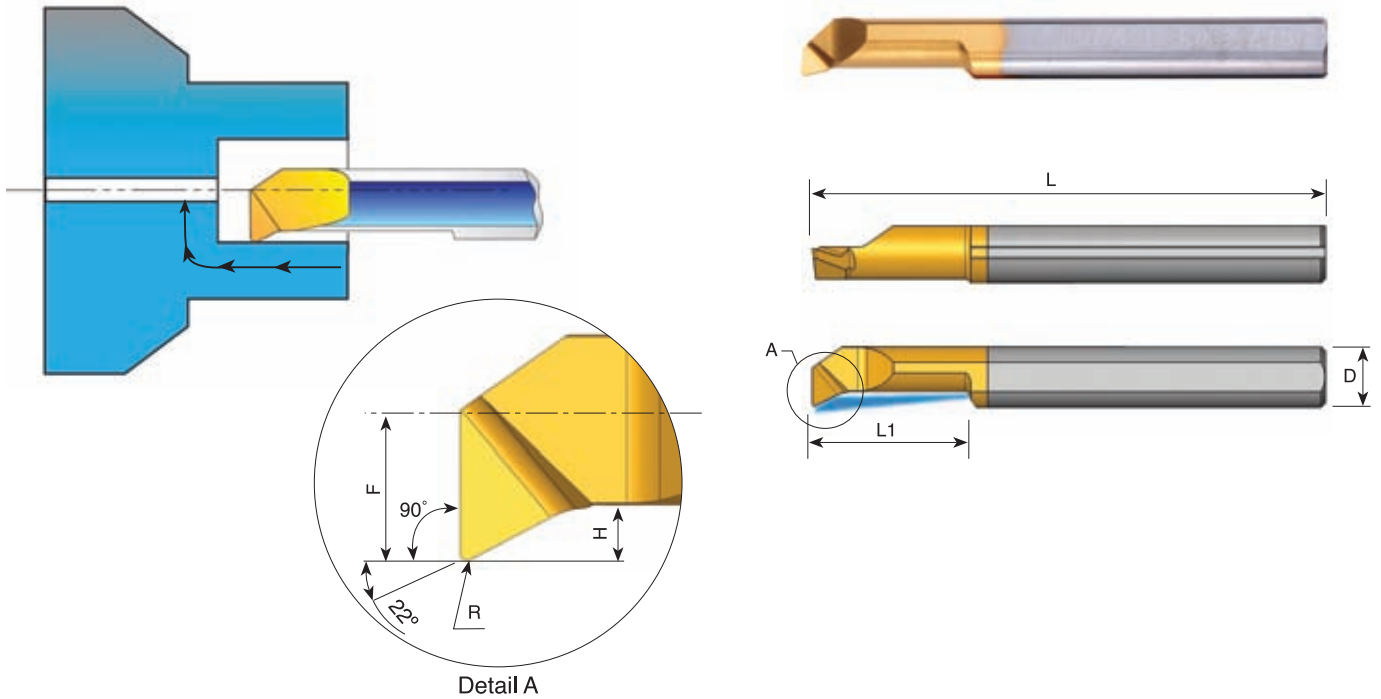

D	Ordering Code	L	L1	R	H	F	Min. Bore Dia.	Holder*
3.0	MUR 3 R0.05 L10	39	10	0.05	0.4	1.3	3.1	SIM 0020 H3
3.0	MUR 3 R0.05 L15	39	15	0.05	0.4	1.3	3.1	SIM 0020 H3
4.0	MUR 4 R0.1 L10	51	10	0.10	0.5	1.7	4.1	SIM 0020 H4
4.0	MUR 4 R0.1 L15	51	15	0.10	0.5	1.7	4.1	SIM 0020 H4
5.0	MUR 5 R0.15 L15	51	15	0.15	0.7	2.1	5.1	SIM 0020 H5
5.0	MUR 5 R0.15 L22	51	22	0.15	0.7	2.1	5.1	SIM 0020 H5
6.0	MUR 6 R0.15 L15	51	15	0.15	0.9	2.8	6.1	SIM 0020 H6
6.0	MUR 6 R0.15 L22	51	22	0.15	0.9	2.8	6.1	SIM 0020 H6
8.0	MUR 8 R0.2 L22	64	22	0.20	1.1	3.8	8.1	SIM 0020 H8

Order example: MUR 5 R0.15 L15 BXC

* For additional holders see page 189-190

MQR Bars Profiling and Boring - with Coolant Channel

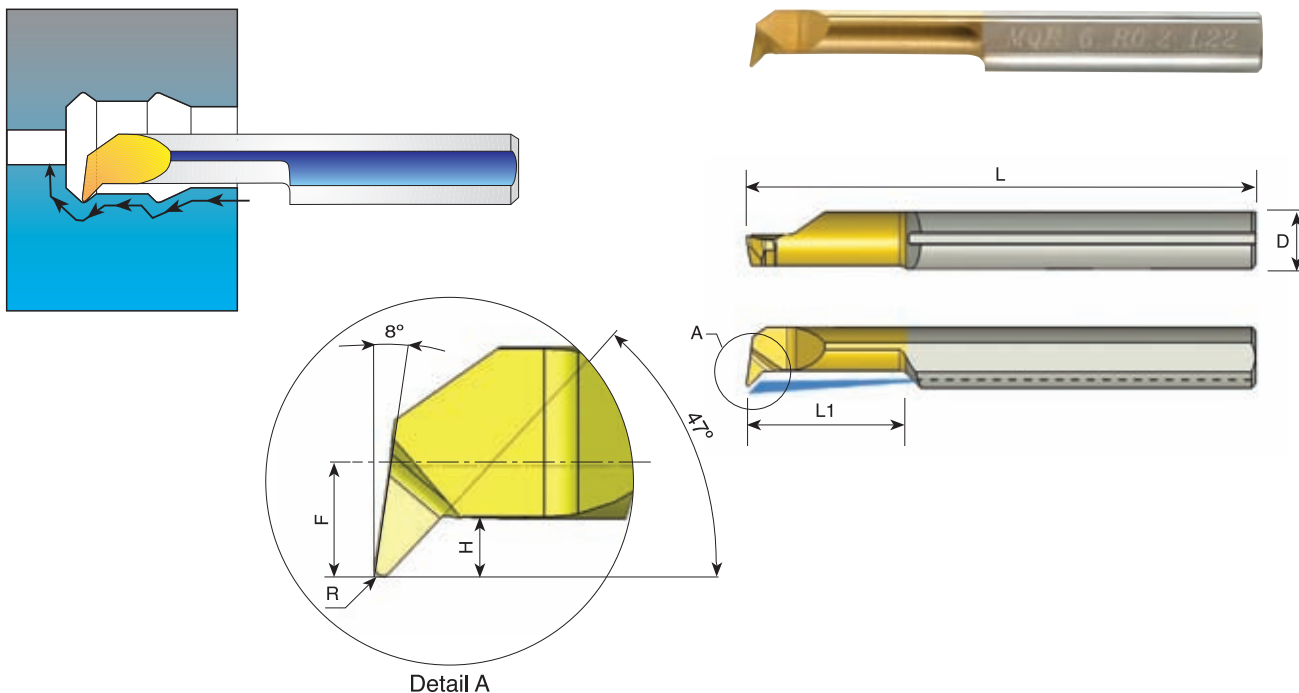

D	Ordering Code	L	L1	R	H	F	Min. Bore Dia.	Holder*
4.0	MQR 4 R0.2 L10	51	10	0.20	0.8	1.8	4.1	SIM 0020 H4
4.0	MQR 4 R0.2 L15	51	15	0.20	0.8	1.8	4.1	SIM 0020 H4
4.0	MQR 4 R0.2 L22	51	22	0.20	0.8	1.8	4.1	SIM 0020 H4
5.0	MQR 5 R0.2 L15	51	15	0.20	1.0	2.3	5.1	SIM 0020 H5
5.0	MQR 5 R0.2 L22	51	22	0.20	1.0	2.3	5.1	SIM 0020 H5
6.0	MQR 6 R0.2 L15	51	15	0.20	1.4	2.8	6.1	SIM 0020 H6
6.0	MQR 6 R0.2 L22	51	22	0.20	1.4	2.8	6.1	SIM 0020 H6
6.0	MQR 6 R0.2 L30	58	30	0.20	1.4	2.8	6.1	SIM 0020 H6
8.0	MQR 8 R0.2 L22	64	22	0.20	1.6	3.8	8.1	SIM 0020 H8
8.0	MQR 8 R0.2 L27	64	27	0.20	2.0	3.8	8.1	SIM 0020 H8

Order example: MQR 5 R0.2 L15 BXC

For L.H. bars specify MQL instead of MQR

* For additional holders see page 189-190

MIR Bars Threading - with Coolant Channel

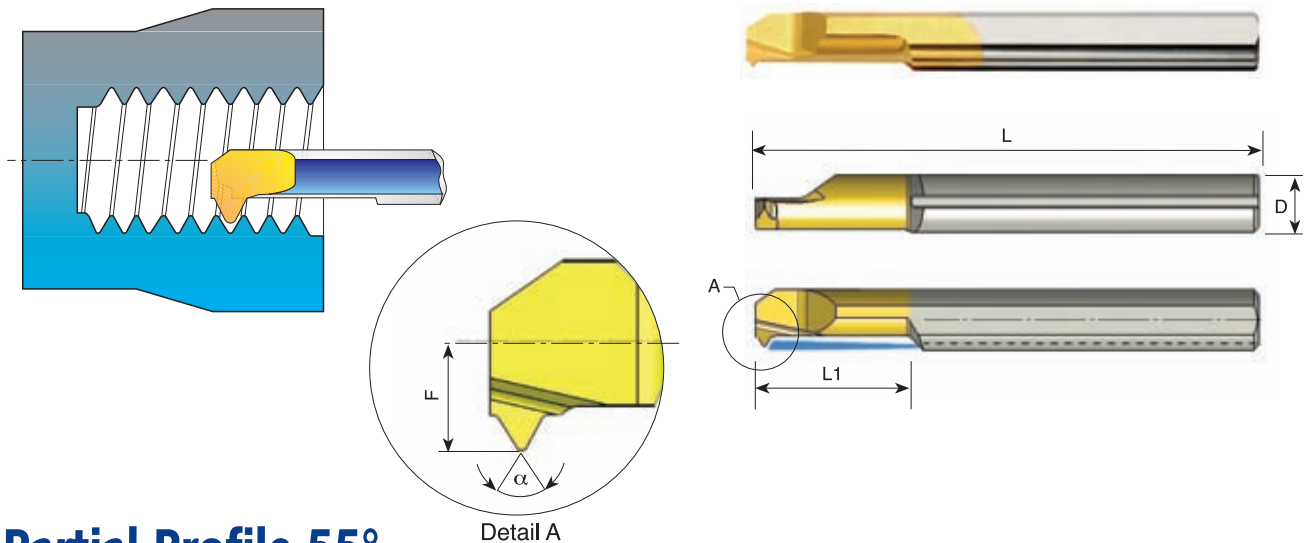

Partial Profile 55°

D	Ordering Code	L	L1	α	Pitch Range		F	Min. Bore Dia.	Holder*
					mm	TPI			
3.0	MIR 3 L15 A55	39	15	55	0.5 -1.0	48-24	1.4	3.2	SIM 0020 H3
4.0	MIR 4 L15 A55	51	15	55	0.5 -1.0	48-24	1.8	4.1	SIM 0020 H4
5.0	MIR 5 L15 A55	51	15	55	0.5 -1.25	48-20	2.3	5.1	SIM 0020 H5
5.0	MIR 5 L22 A55	51	22	55	0.5 -1.25	48-20	2.3	5.1	SIM 0020 H5
6.0	MIR 6 L15 A55	51	15	55	0.5 -1.5	48-16	2.6	6.0	SIM 0020 H6
6.0	MIR 6 L22 A55	51	22	55	0.5 -1.5	48-16	2.6	6.0	SIM 0020 H6

Order example: MIR 5 L15 A55 BXC

Partial Profile 60°

D	Ordering Code	L	L1	α	Pitch Range		F	Min. Bore Dia.	Holder*
					mm	TPI			
1.0	*MIR 1 L5 A60	39	4.8	60	0.25-0.35	100-72	0.55	1.2	SIM 0020 H1
1.0	*MIR 1.5 L6 A60	39	6.3	60	0.35-0.45	72-56	0.65	1.4	SIM 0020 H1
3.0	*MIR 2 L8 A60	39	8	60	0.45-0.7	56-32	1.0	2.1	SIM 0020 H3
3.0	MIR 3 L15 A60	39	15	60	0.7 -1.0	32-24	1.4	3.2	SIM 0020 H3
4.0	MIR 4 L15 A60	51	15	60	0.8 -1.0	32-24	1.8	4.1	SIM 0020 H4
5.0	MIR 5 L15 A60	51	15	60	1.0 -1.25	24-20	2.3	5.1	SIM 0020 H5
5.0	MIR 5 L22 A60	51	22	60	1.0 -1.25	24-20	2.3	5.1	SIM 0020 H5
6.0	MIR 6 L15 A60	51	15	60	1.0 -1.5	24-16	2.6	6.0	SIM 0020 H6
6.0	MIR 6 L22 A60	51	22	60	1.0 -1.5	24-16	2.6	6.0	SIM 0020 H6
8.0	MIR 8 L22 A60	64	22	60	1.0 -2.0	24-13	3.6	8.0	SIM 0020 H8

Order example: MIR 5 L15 A60 BXC

For L.H. bars specify MIL instead of MIR

* For additional holders see page 189-190

* Without coolant

MIR Bars Threading - with Coolant Channel

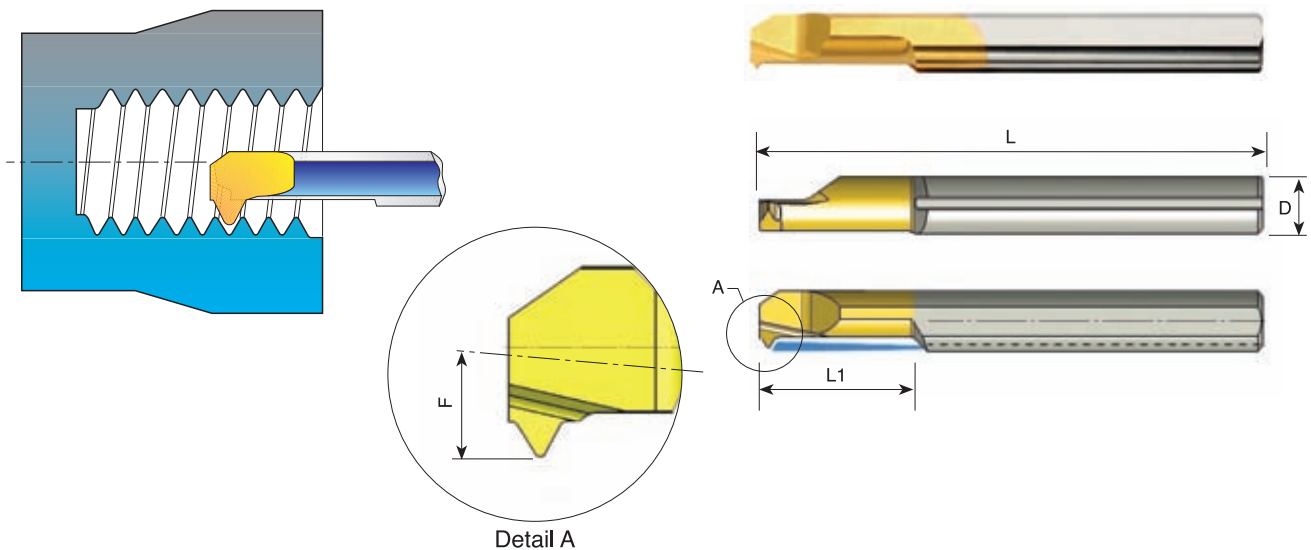

Full Profile - ISO 60°

D	Ordering Code	Thread	L	L1	F	Min. Bore Dia.	Holder*
3.0	MIR 3 L15 0.5 ISO	M4 x 0.5	39	15	1.4	3.2	SIM 0020 H3
3.0	MIR 3 L15 0.7 ISO	M4 x 0.7	39	15	1.4	3.2	SIM 0020 H3
3.0	MIR 3 L15 0.75 ISO	M4.5 x 0.75	39	15	1.4	3.2	SIM 0020 H3
4.0	MIR 4 L15 0.5 ISO	M5 x 0.5	51	15	1.8	4.1	SIM 0020 H4
4.0	MIR 4 L15 0.75 ISO	M5 x 0.75	51	15	1.8	4.1	SIM 0020 H4
4.0	MIR 4 L15 0.8 ISO	M5 x 0.8	51	15	1.8	4.1	SIM 0020 H4
5.0	MIR 5 L15 1.0 ISO	M6 x 1.0	51	15	2.2	4.9	SIM 0020 H5
6.0	MIR 6 L22 1.25 ISO	M8 x 1.25	51	22	2.8	6.1	SIM 0020 H6

Order example: MIR 5 L15 1.0 ISO BXC

Full Profile - UN 60°

D	Ordering Code	Thread	L	L1	F	Min. Bore Dia.	Holder*
3.0	MIR 3 L15 36 UN	8-36UNF	39	15	1.4	3.2	SIM 0020 H3
3.0	MIR 3 L15 32 UN	8-32UNC	39	15	1.4	3.2	SIM 0020 H3
4.0	MIR 4 L15 36 UN	12-36UNS	51	15	1.8	4.1	SIM 0020 H4
4.0	MIR 4 L15 32 UN	12-32UNEF	51	15	1.8	4.1	SIM 0020 H4
5.0	MIR 5 L15 28 UN	1/4-28UNF	51	15	2.2	4.9	SIM 0020 H5
5.0	MIR 5 L18 20 UN	1/4-20UNC	51	18	2.3	5.0	SIM 0020 H5
6.0	MIR 6 L18 24 UN	5/16-24UNF	51	18	2.8	6.5	SIM 0020 H6
6.0	MIR 6 L18 18 UN	5/16-18UNC	51	18	2.8	6.2	SIM 0020 H6

Order example: MIR 4 L15 36 UN BXC

For L.H. bars specify MIL instead of MIR

* For additional holders see page 189-190

MIR Bars Threading - with Coolant Channel

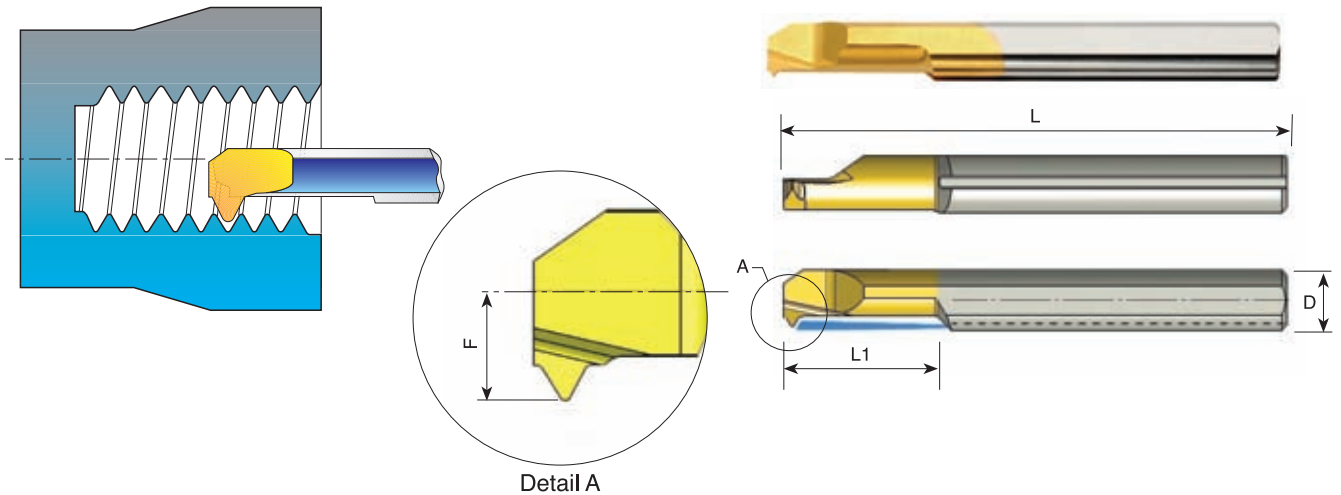

Full Profile - NPT 60°

D	Ordering Code	Pitch TPI	L	L1	F	Min. Bore Dia.	Thread Size	Holder*
6.0	MIR 6 L15 27 NPT	27	51	15	2.6	5.9	1/16 x 27NPT 1/8 x 27NPT	SIM 0020 H6

Ordering example: MIR 6 L15 27 NPT BXC

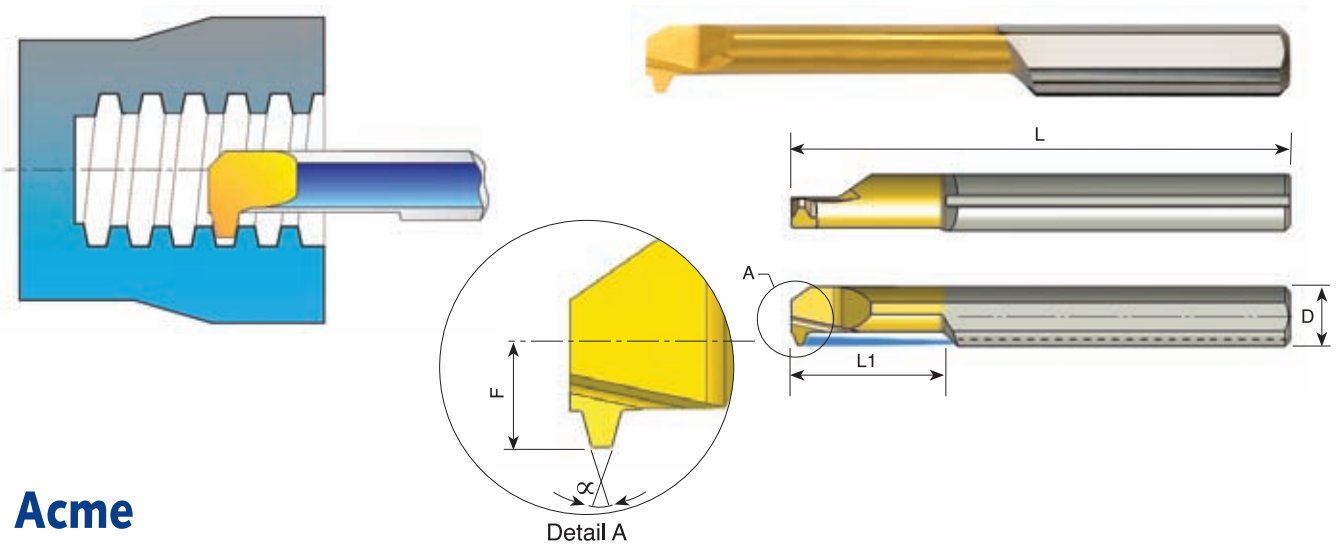

Acme

D	Ordering Code	Pitch TPI	L	L1	F	α	Min. Bore Dia.	Thread Size	Holder*
4.0	MIR 4 L15 16 ACME	16	51	15	1.8	29	4.6	1/4 x 16	SIM 0020 H4
6.0	MIR 6 L20 14 ACME	14	51	20	2.8	29	6.0	5/16 X 14	SIM 0020 H6
7.0	MIR 7 L22 12 ACME	12	62	22	3.3	29	7.2	3/8 X 12	SIM 0020 H7

Ordering example: MIR 6 L 20 14 ACME BXC
* For additional holders see page 189-190

MIR Bars Threading - with Coolant Channel

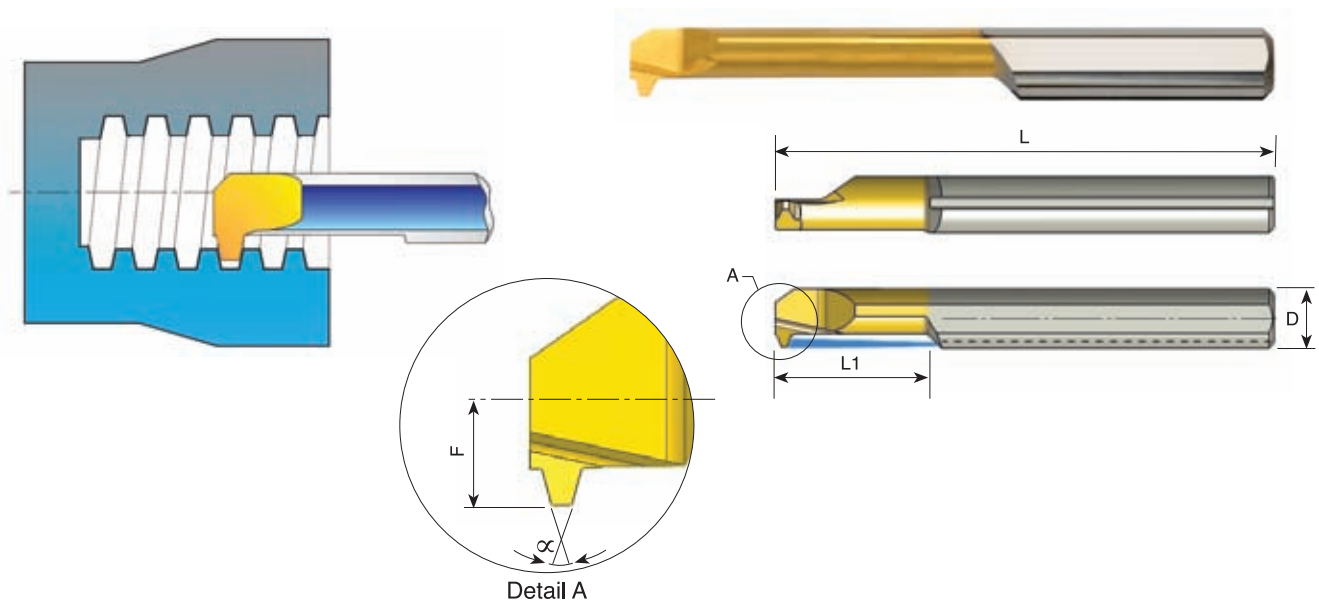

Partial Profile Trapez - DIN 103

D	Ordering Code	Pitch mm	L	L1	F	α	Min.Bore Diameter	Thread Size	Holder*
7.0	MIR 7 L25 2 TR	2	62	25	3.2	30	6.9	Tr 9 x 2 Tr 10 x 2 Tr 11 x 2 Tr 12 x 2	SIM 0020 H7
10.0	MIR 10 L35 2 TR	2	73	35	4.8	30	11.0	Tr 14 x 2 Tr 16 x 2 Tr 18 x 2 Tr 20 x 2	SIM 0020 H10
7.0	MIR 7 L35 3 TR	3	62	35	3.3	30	7.5	Tr 11 x 3 Tr 12 x 3	SIM 0020 H7
10.0	MIR 10 L35 3 TR	3	73	35	4.8	30	10.5	Tr 14 x 3 Tr 22 x 3 Tr 24 x 3 Tr 26 x 3 Tr 28 x 3	SIM 0020 H10
10.0	MIR 10 L45 4 TR	4	105	45	4.8	30	11.5	Tr 16 x 4 Tr 18 x 4 Tr 20 x 4	SIM 0020 H10
10.0	MIR 10 L55 5 TR	5	105	55	4.8	30	11.0	Tr 22 x 5 Tr 24 x 5 Tr 28 x 5	SIM 0020 H10

Ordering example: MIR 10 L35 3 TR BXC

* For additional holders see page 189-190

MDR Bars Thread Relief, Chamfering and Grooving - with Coolant Channel

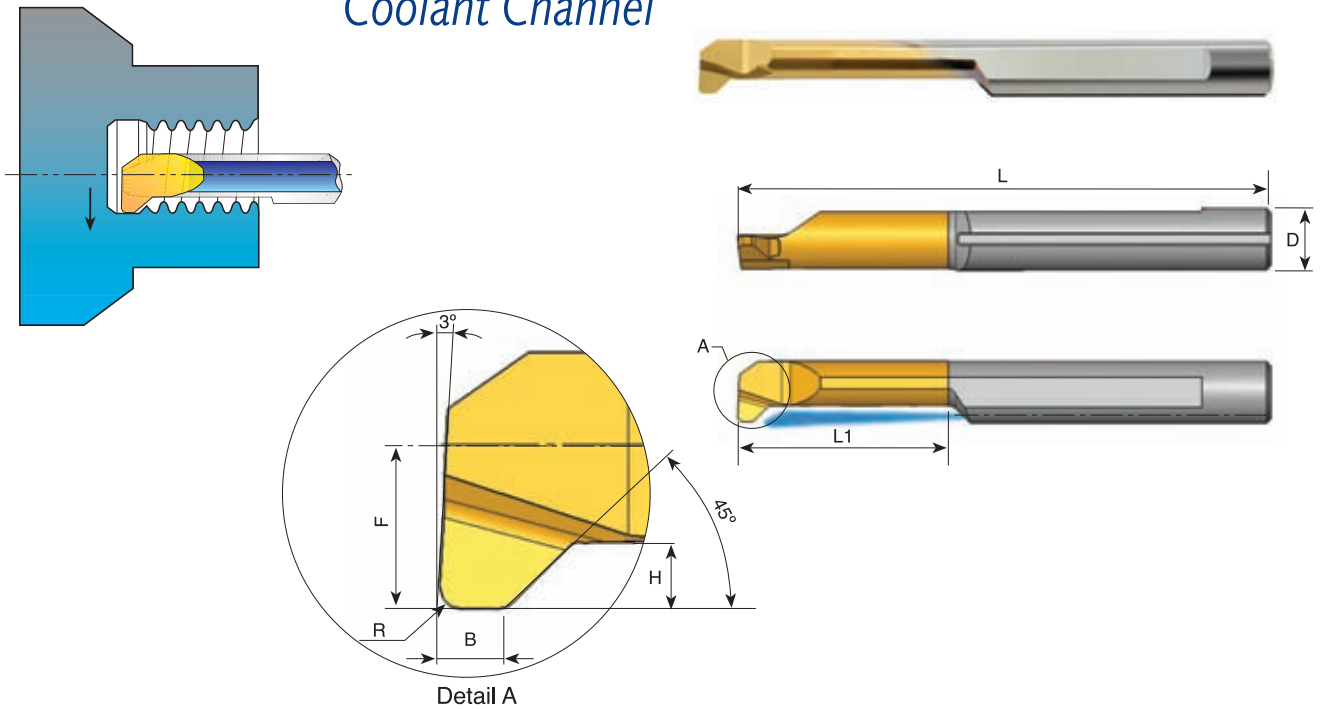

D	Ordering Code	L	L1	B	R	H	F	Min. Bore Dia.	Holder*
4.0	MDR 4 R0.5 L18	51	18	1.50	0.5	0.8	1.8	4.1	SIM 0020 H4
5.0	MDR 5 R0.5 L24	51	24	1.50	0.5	1.2	2.3	5.1	SIM 0020 H5
6.0	MDR 6 R0.5 L27	58	27	1.50	0.5	1.4	2.8	6.1	SIM 0020 H6

Order example: MDR 5 R0.5 L24 BXC

For L.H. bars specify MDL instead of MDR

* For additional holders see page 189-190

MCR Bars Chamfering and Boring - with Coolant Channel

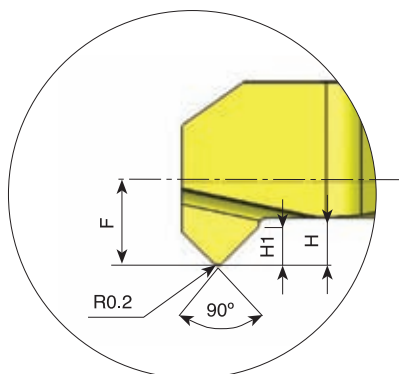
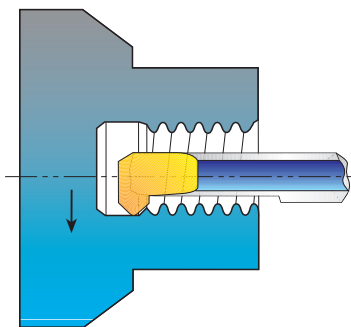

Detail A

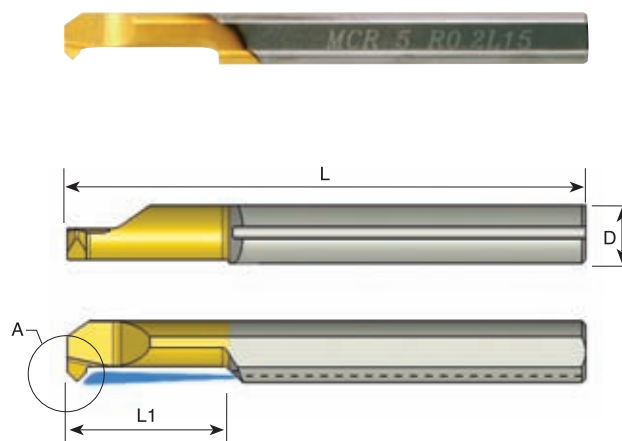

D	Ordering Code	L	L1	R	H	H1	F	Min. Bore Dia.	Holder*
3.0	MCR 3 R0.2 L10	39	10	0.20	0.7	0.3	1.3	3.1	SIM 0020 H3
4.0	MCR 4 R0.2 L15	51	15	0.20	0.8	0.4	1.7	4.1	SIM 0020 H4
5.0	MCR 5 R0.2 L15	51	15	0.20	1.2	0.7	2.1	5.1	SIM 0020 H5
6.0	MCR 6 R0.2 L15	51	15	0.20	1.4	0.7	2.8	6.1	SIM 0020 H6

Order example: MCR 4 R0.2 L15 BXC

For L.H. bars specify MCL instead of MCR

* For additional holders see page 189-190

MWR Bars Chamfering and Profiling - with Coolant Channel

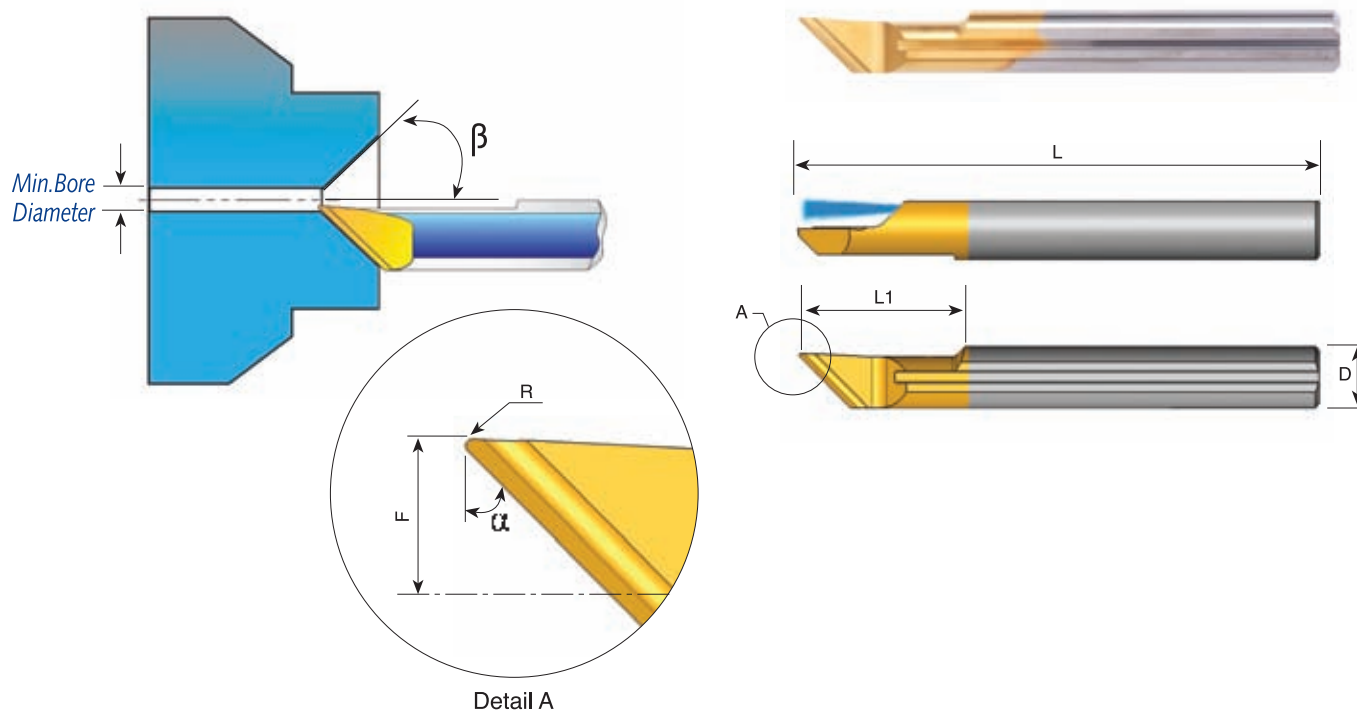

D	Ordering Code	L	L1	R	α	β	F	Min. Bore Dia.	Holder*
6.0	MWR 6 R0.2 A90	51	15.0	0.20	45°	45°	2.3	1.0	SIM 0020 H6
6.0	MWR 6 R0.2 A60	51	15.0	0.20	60°	30°	2.3	1.0	SIM 0020 H6

Ordering example: MWR 6 R0.2 A90 BXC

For L.H. bars specify MWL instead of MWR

* For additional holders see page 189-190

MGR Bars Grooving - with Coolant Channel

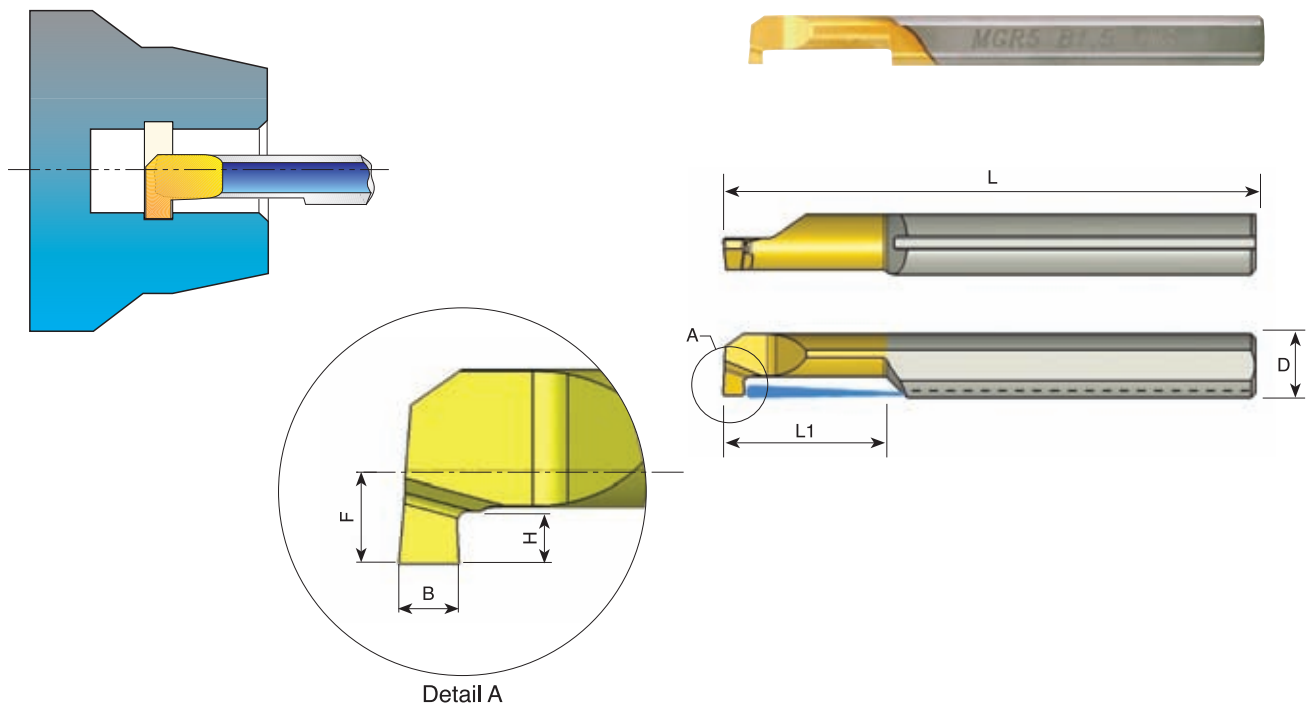

D	Ordering Code	L	L1	B	H	F	Min. Bore Dia.	Holder*
3.0	MGR 3 B0.7 L10	39	10	0.7	0.6	1.3	3.1	SIM 0020 H3
4.0	MGR 4 B1.0 L10	51	10	1.0	1.0	1.7	4.1	SIM 0020 H4
4.0	MGR 4 B1.5 L10	51	10	1.5	1.0	1.7	4.1	SIM 0020 H4
5.0	MGR 5 B1.0 L15	51	15	1.0	1.2	2.3	5.1	SIM 0020 H5
5.0	MGR 5 B1.5 L15	51	15	1.5	1.2	2.3	5.1	SIM 0020 H5
5.0	MGR 5 B2.0 L15	51	15	2.0	1.2	2.3	5.1	SIM 0020 H5
6.0	MGR 6 B1.0 L15	51	15	1.0	1.4	2.8	6.1	SIM 0020 H6
6.0	MGR 6 B1.5 L15	51	15	1.5	1.4	2.8	6.1	SIM 0020 H6
6.0	MGR 6 B2.0 L15	51	15	2.0	1.4	2.8	6.1	SIM 0020 H6
8.0	MGR 8 B1.0 L22	64	22	1.0	1.7	3.8	8.1	SIM 0020 H8
8.0	MGR 8 B1.5 L22	64	22	1.5	1.7	3.8	8.1	SIM 0020 H8
8.0	MGR 8 B2.0 L22	64	22	2.0	2.6	3.8	8.1	SIM 0020 H8

Ordering example: MGR 5 B1.5 L15 BXC

For L.H. bars specify MGL instead of MGR

* For additional holders see page 189-190

MKR Bars Full Radius Grooving - with Coolant Channel

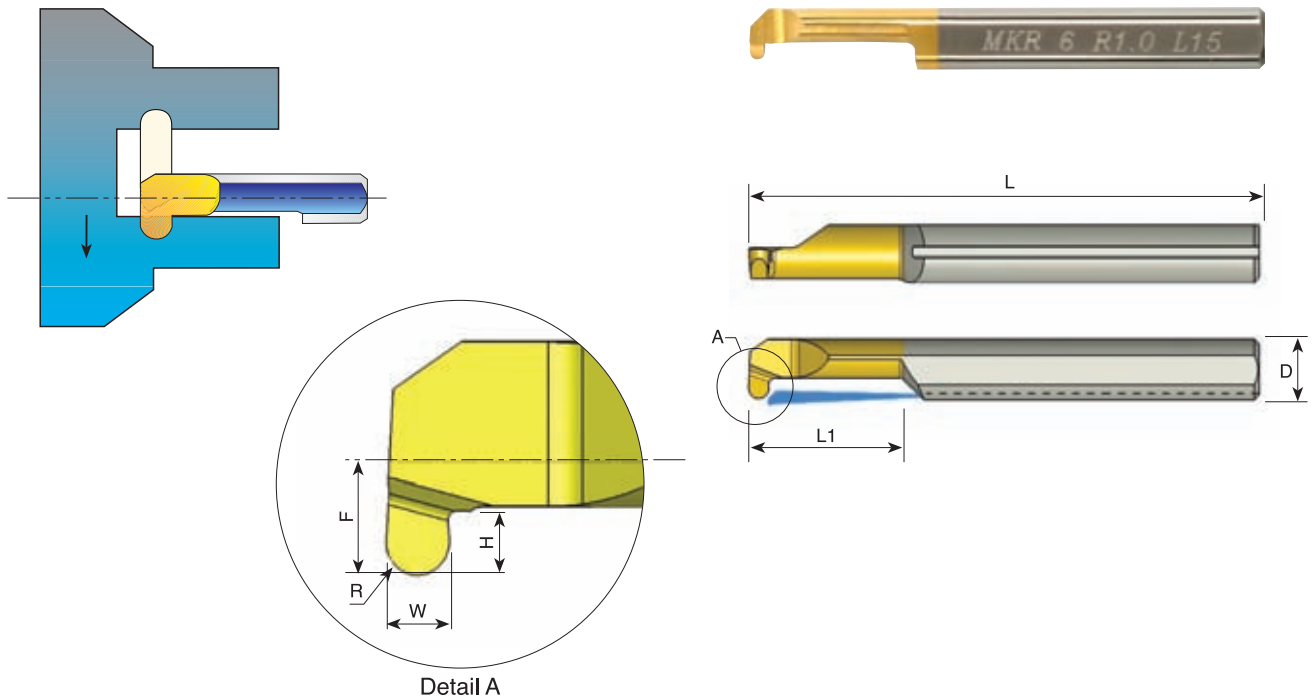

D	Ordering Code	L	L1	R	W	H	F	Min. Bore Dia.	Holder*
4.0	MKR 4 R0.5 L10	51	10	0.50	1.0	1.0	1.7	4.1	SIM 0020 H4
4.0	MKR 4 R0.75 L10	51	10	0.75	1.5	1.0	1.7	4.1	SIM 0020 H4
5.0	MKR 5 R0.5 L15	51	15	0.50	1.0	1.2	2.3	5.1	SIM 0020 H5
5.0	MKR 5 R0.75 L15	51	15	0.75	1.5	1.2	2.3	5.1	SIM 0020 H5
5.0	MKR 5 R1.0 L15	51	15	1.00	2.0	1.2	2.3	5.1	SIM 0020 H5
6.0	MKR 6 R0.5 L15	51	15	0.50	1.0	1.6	2.8	6.1	SIM 0020 H6
6.0	MKR 6 R0.75 L15	51	15	0.75	1.5	1.6	2.8	6.1	SIM 0020 H6
6.0	MKR 6 R1.0 L15	51	15	1.00	2.0	1.6	2.8	6.1	SIM 0020 H6

Ordering example: MKR 5 R1.0 L15 BXC

For L.H. bars specify MKL instead of MKR

* For additional holders see page 189-190

MFR Bars Face Grooving - with Coolant Channel

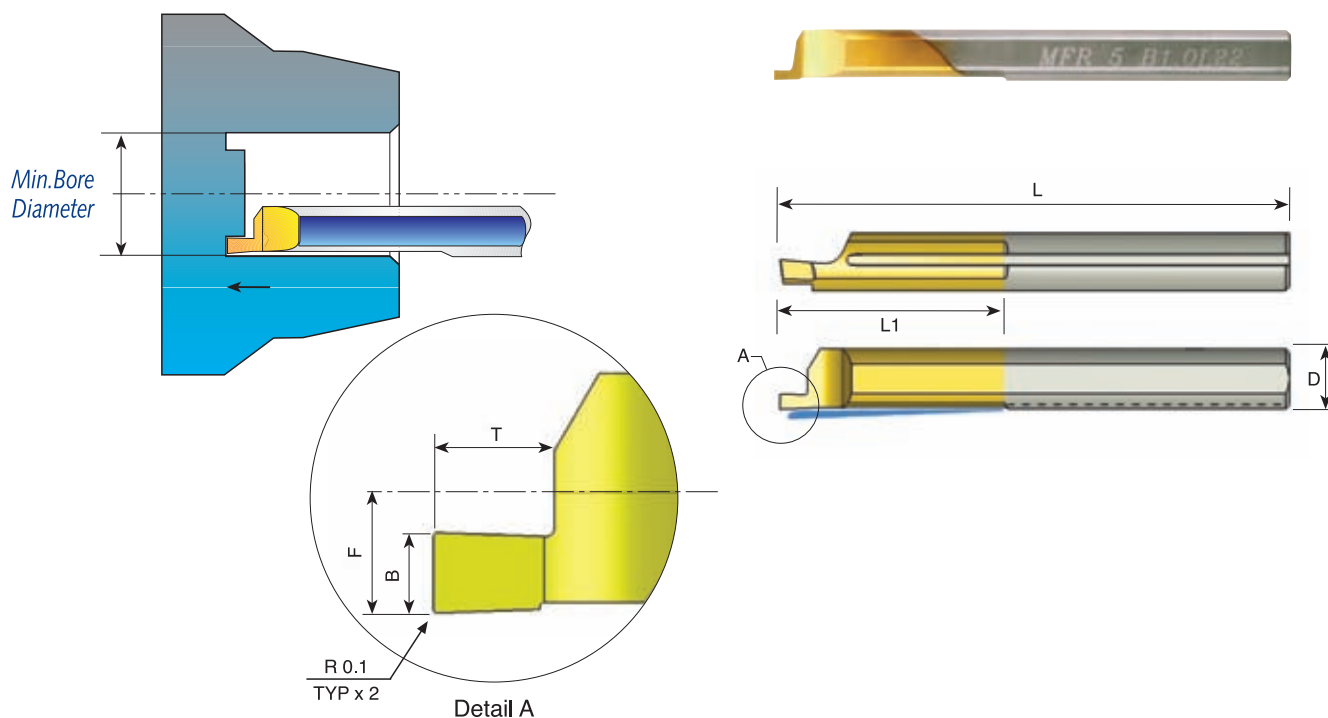

D	Ordering Code	L	L1	B	T	F	Min. Bore Dia.	Holder*
4.0	MFR 4 B0.75 L15	51	15	0.75	1.2	1.95	5.0	SIM 0020 H4
4.0	MFR 4 B1.0 L15	51	15	1.0	1.5	1.95	5.0	SIM 0020 H4
4.0	MFR 4 B1.5 L15	51	15	1.5	2.8	1.95	5.0	SIM 0020 H4
5.0	MFR 5 B0.75 L22	51	22	0.75	1.2	2.45	6.0	SIM 0020 H5
5.0	MFR 5 B1.0 L22	51	22	1.0	1.5	2.45	6.0	SIM 0020 H5
5.0	MFR 5 B1.5 L22	51	22	1.5	2.5	2.45	6.0	SIM 0020 H5
5.0	MFR 5 B2.0 L22	51	22	2.0	3.8	2.45	6.0	SIM 0020 H5
6.0	MFR 6 B1.0 L22	51	22	1.0	1.5	2.95	8.0	SIM 0020 H6
6.0	MFR 6 B1.5 L22	51	22	1.5	2.5	2.95	8.0	SIM 0020 H6
6.0	MFR 6 B2.0 L22	51	22	2.0	3.0	2.95	8.0	SIM 0020 H6
6.0	MFR 6 B2.5 L22	51	22	2.5	4.8	2.95	8.0	SIM 0020 H6
6.0	MFR 6 B3.0 L30	58	30	3.0	6.0	2.95	8.0	SIM 0020 H6
8.0	MFR 8 B2.5 L22	64	22	2.5	3.5	3.95	10.0	SIM 0020 H8

Ordering example: MFR 5 B1.0 L22 BXC

* For additional holders see page 189-190

MFL Bars Face Grooving - with Coolant Channel

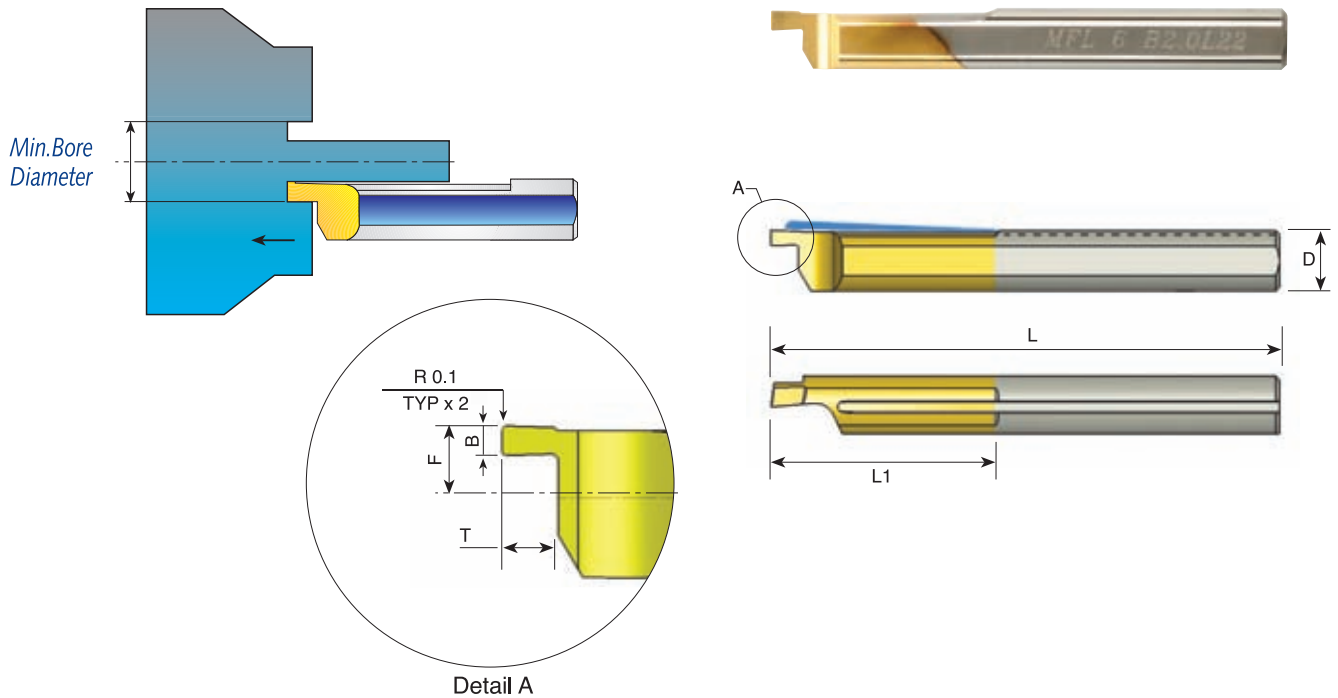

D	Ordering Code	L	L1	B	T	F	Min. Bore Dia.	Holder*
4.0	MFL 4 B0.75 L15	51	15	0.75	1.2	1.75	5.0	SIM 0020 H4
4.0	MFL 4 B1.0 L15	51	15	1.0	1.5	1.75	5.0	SIM 0020 H4
4.0	MFL 4 B1.5 L15	51	15	1.5	2.8	1.75	5.0	SIM 0020 H4
5.0	MFL 5 B0.75 L22	51	22	0.75	1.2	2.25	6.0	SIM 0020 H5
5.0	MFL 5 B1.0 L22	51	22	1.0	1.5	2.25	6.0	SIM 0020 H5
5.0	MFL 5 B1.5 L22	51	22	1.5	2.5	2.25	6.0	SIM 0020 H5
5.0	MFL 5 B2.0 L22	51	22	2.0	3.8	2.25	6.0	SIM 0020 H5
6.0	MFL 6 B1.0 L22	51	22	1.0	1.5	2.75	8.0	SIM 0020 H6
6.0	MFL 6 B1.5 L22	51	22	1.5	2.5	2.75	8.0	SIM 0020 H6
6.0	MFL 6 B2.0 L22	51	22	2.0	3.0	2.75	8.0	SIM 0020 H6
6.0	MFL 6 B2.5 L22	51	22	2.5	4.8	2.75	8.0	SIM 0020 H6
6.0	MFL 6 B3.0 L30	58	30	3.0	6.0	2.75	8.0	SIM 0020 H6
8.0	MFL 8 B2.5 L22	64	22	2.5	3.5	3.75	10.0	SIM 0020 H8

Ordering example: MFL 6 B1.0 L22 BXC

* For additional holders see page 189-190

MVR Bars Deep Face Grooving - with 2 Coolant Bores

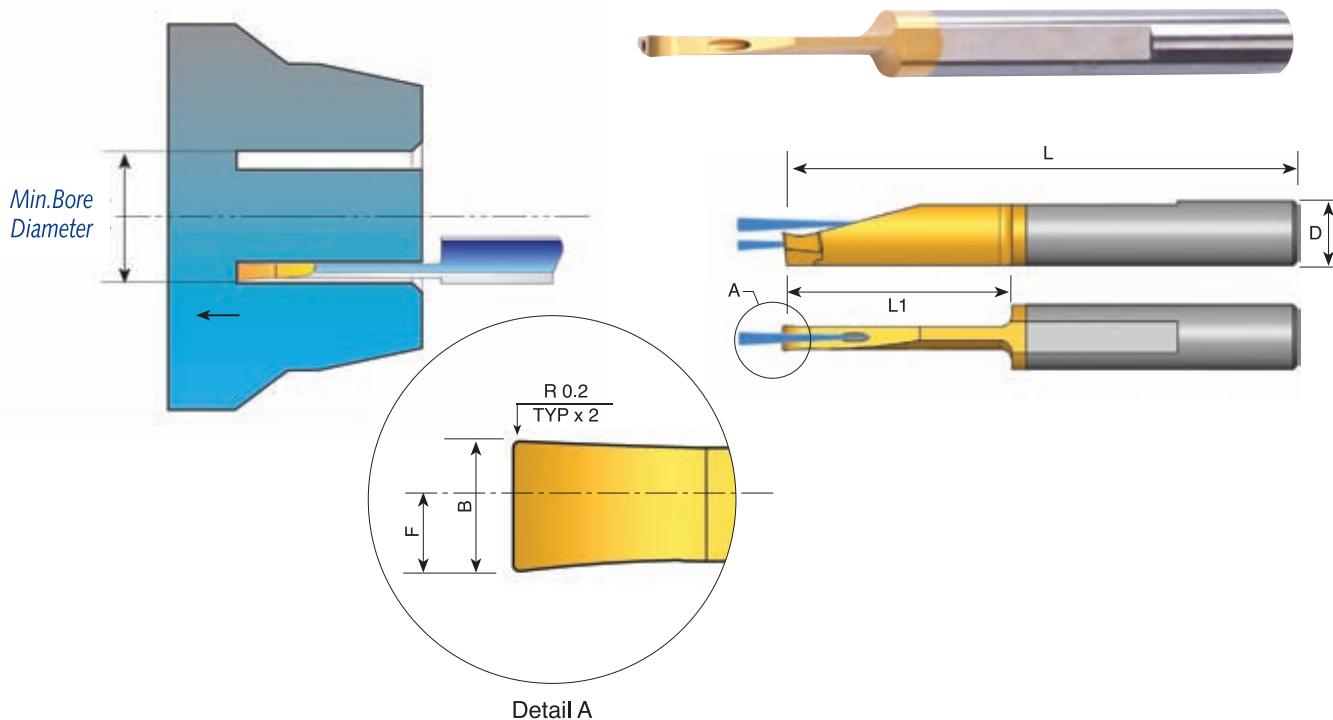

D	Ordering Code	L	L1	B	F	Min. Bore Dia.	Holder*
6.0	MVR 6 B2.0 L15	64	15	2.0	1.1	12.0	SIM 0020 H6
6.0	MVR 6 B2.0 L22	64	22	2.0	1.1	12.0	SIM 0020 H6
6.0	MVR 6 B2.5 L22	64	22	2.5	1.4	12.0	SIM 0020 H6
8.0	MVR 8 B3.0 L27	64	27	3.0	1.6	15.0	SIM 0020 H8
8.0	MVR 8 B3.0 L43	80	43	3.0	1.6	15.0	SIM 0020 H8
8.0	MVR 8 B4.0 L43	80	43	4.0	2.1	20.0	SIM 0020 H8

Order example: MVR 6 B2.0 L22 BXC

* For additional holders see page 189-190

MZR Bars Face Grooving - with Coolant Channel

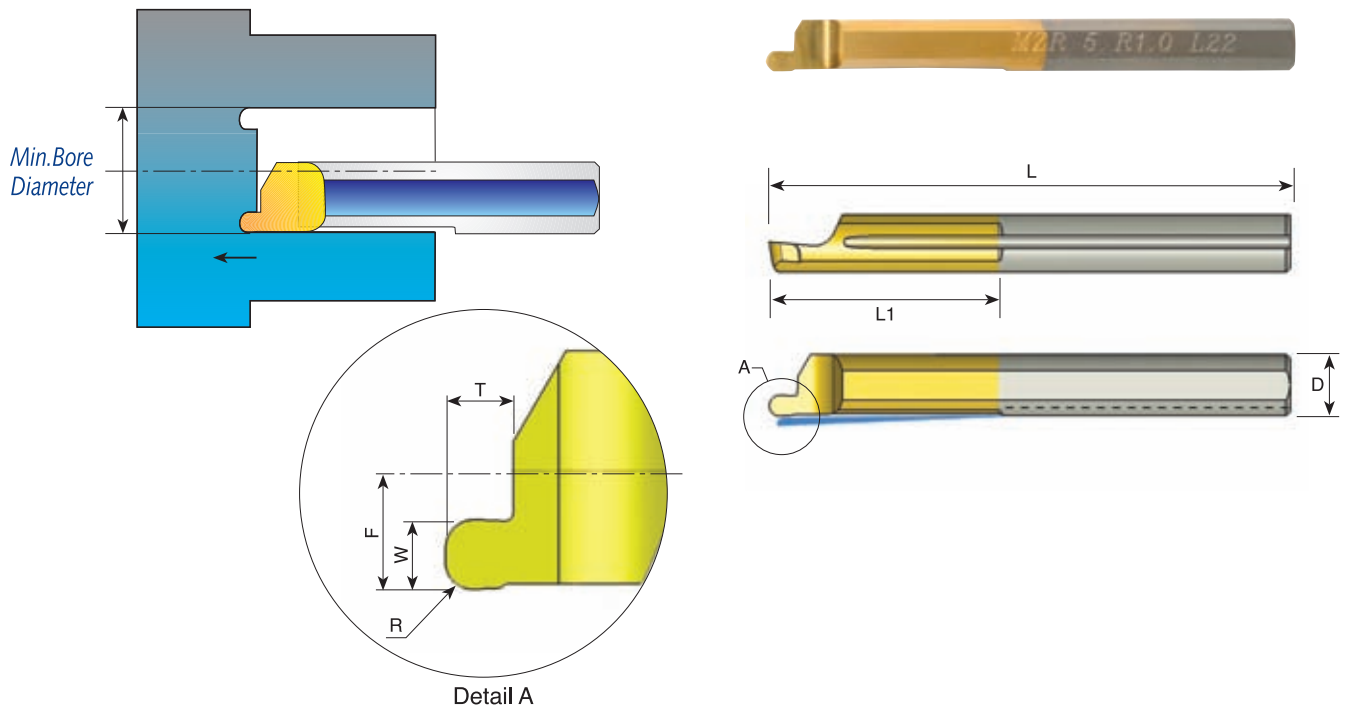

D	Ordering Code	L	L1	R	W	T	F	Min. Bore Dia.	Holder*
4.0	MZR 4 R0.5 L15	51	15	0.50	1.0	1.2	1.95	5.0	SIM 0020 H4
4.0	MZR 4 R0.75 L15	51	15	0.75	1.5	1.5	1.95	5.0	SIM 0020 H4
5.0	MZR 5 R0.5 L22	51	22	0.50	1.0	1.2	2.45	6.0	SIM 0020 H5
5.0	MZR 5 R0.75 L22	51	22	0.75	1.5	1.5	2.45	6.0	SIM 0020 H5
5.0	MZR 5 R1.0 L22	51	22	1.00	2.0	2.5	2.45	6.0	SIM 0020 H5
6.0	MZR 6 R0.5 L22	51	22	0.50	1.0	1.2	2.95	8.0	SIM 0020 H6
6.0	MZR 6 R0.75 L22	51	22	0.75	1.5	1.5	2.95	8.0	SIM 0020 H6
6.0	MZR 6 R1.0 L22	51	22	1.00	2.0	2.5	2.95	8.0	SIM 0020 H6

Order example: MZR 5 R0.5 L22 BXC

* For additional holders see page 189-190

Tiny Tools Bar Holders

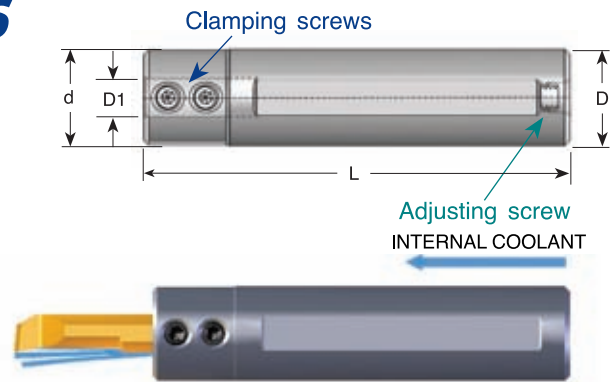

D1	Ordering Code	L	D	d	Key	Clamping Screw	Adjusting Screw
3.0	SIM0012 H3	88	12	12	K25	S24	S35
3.0	* SIM0016 H3S	75	16	20	K25	S25	S35S
3.0	SIM0016 H3	88	16	20	K25	S25	S35
3.0	SIM0020 H3	88	20	20	K25	S25	S35
3.0	* SIM0022 H3	88	22	22	K25	S25	S35
4.0	SIM0012 H4	88	12	12	K25	S24	S35
4.0	* SIM0016 H4S	75	16	20	K25	S25	S35S
4.0	SIM0016 H4	88	16	20	K25	S25	S35
4.0	SIM0020 H4	88	20	20	K25	S25	S35
4.0	* SIM0022 H4	88	22	22	K25	S25	S35
5.0	SIM0012 H5	88	12	12	K25	S24	S35
5.0	* SIM0016 H5S	75	16	20	K25	S25	S35S
5.0	SIM0016 H5	88	16	20	K25	S25	S35
5.0	SIM0020 H5	88	20	20	K25	S25	S35
5.0	* SIM0022 H5	75	22	22	K25	S25	S35
6.0	* SIM0016 H6S	75	16	20	K25	S25	S35S
6.0	SIM0016 H6	88	16	20	K25	S25	S35
6.0	SIM0020 H6	88	20	20	K25	S25	S35
6.0	* SIM0022 H6	88	22	22	K25	S25	S35
7.0	SIM0016 H7	88	16	20	K25	S25	S35
7.0	SIM0020 H7	88	20	20	K25	S25	S35
8.0	SIM0016 H8	88	16	20	K25	S25	S35
8.0	SIM0020 H8	88	20	20	K25	S25	S35
10.0	SIM0020 H10	88	20	20	K25	S25	S35

* Can also be used with Swiss type lathe machines

Tools Bar Holders

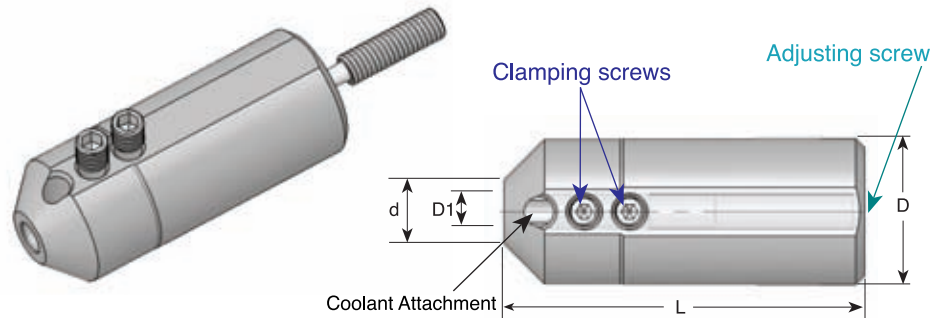

D1	Ordering Code	L	D	d	Key	Clamping Screw	Adjusting Screw
3.0	SIM0025 H3	62	25	10.8	K25	S25	S35M
4.0	SIM0025 H4	62	25	10.8	K25	S25	S35M
5.0	SIM0025 H5	62	25	10.8	K25	S25	S35M
6.0	SIM0025 H6	62	25	10.8	K25	S25	S35M



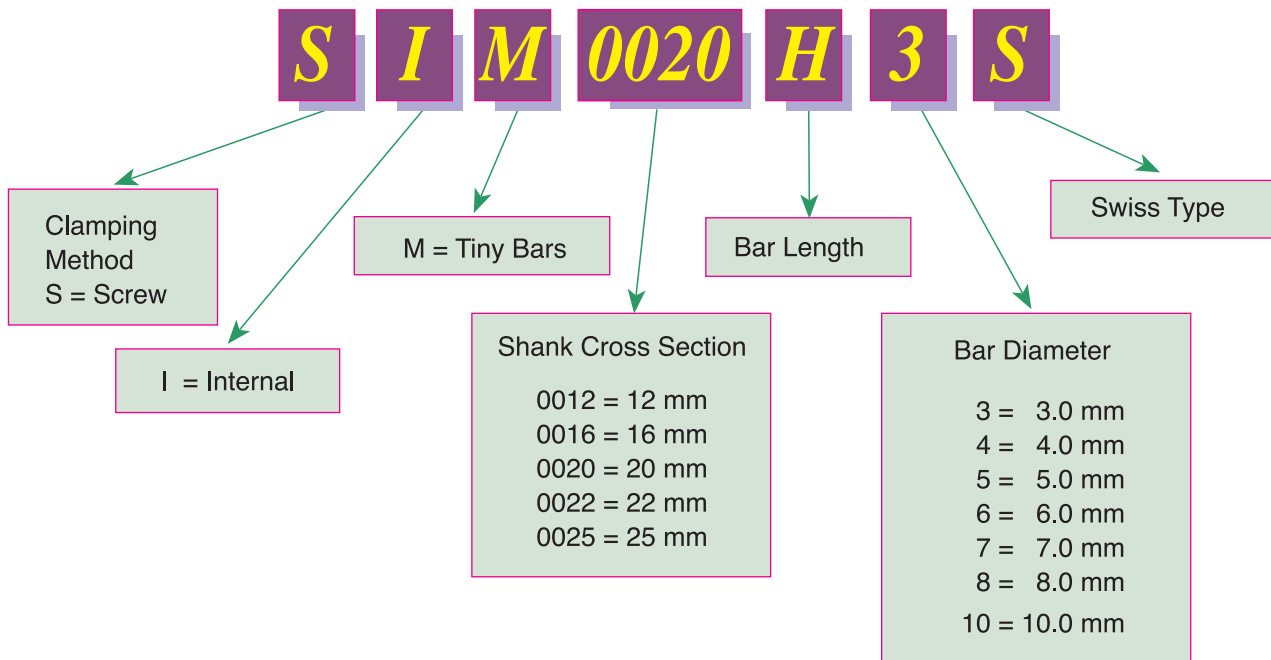

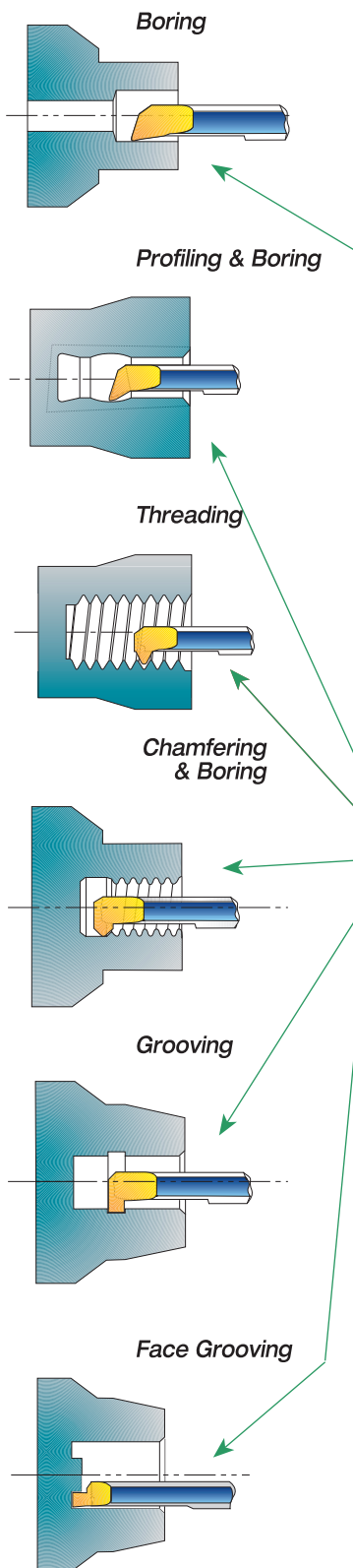

Product Identification Tiny Bar Holders Ordering Codes



Tiny Tools Kits



KT4-20	KT5-20
MTR 4 R0.2 L10	MTR 5 R0.2 L15
MPR 4 R0.2 L10	MPR 5 R0.2 L15
MIR 4 L15 A60	MIR 5 L15 A60
MCR 4 R0.2 L15	MCR 5 R0.2 L15
MGR 4 B1.5 L10	MGR 5 B1.5 L15
MFR 4 B1.0 L15	MFR 5 B1.0 L22
SIM 0020 H4	SIM 0020 H5
K25	K25

-  Boring
-  Profiling
-  Threading
-  Chamfering
-  Grooving
-  Face Grooving

Tiny Tools Bar Holder



Order example: KT4-20

Also available are kits with a 16mm or 22mm shank diameter bar holder.

Order example: KT4-16

Technical Section

Carbide Grade: **BXC (P30 - P50, K25 - K40)**
 PVD TiN coated grade for low cutting speed.
 Works well with a wide range of stainless steels.

Carbide Grade: **BMK (K10 - K20)**

Sub-micron grade with advanced PVD triple blue coating. Extremely high heat resistant and smooth cutting operation, for high performance, and normal machining conditions.
 General purpose for all materials.



Cutting speed for Tiny Tools

ISO Standard	Material		Condition	Cutting Speed m/min	
				BXC	BMK
P	Non-Alloy steel and cast steel, free cutting steel	<0.25%C	Annealed	25-50	30-60
		≥0.25%C	Annealed		
		< 0.55%C	Quenched and tempered		
		≥0.55%C	Annealed		
	Low alloy steel and cast steel (less than 5% alloying elements)		Quenched and tempered	20-25	24-30
			Annealed		
High alloy steel, cast steel, and tool steel		Annealed	18-20	22-24	
		Quenched and tempered			
M	Stainless steel and cast steel		Ferritic/martensitic	25-30	30-42
			Martensitic		
			Austenitic		
K	Cast iron nodular (GGG)		Ferritic/pearlitic	17-23	20-28
			Pearlitic		
	Grey cast iron (GG)		Ferritic	17-23	20-28
			Pearlitic		
	Malleable cast iron		Ferritic	17-23	20-28
			Pearlitic		
N	Aluminum-wrought alloy		Not cureable	50-70	60-84
			Cured		
	Aluminum-cast, alloyed	≤12% Si	Not cureable	30-40	36-48
			Cured		
	Copper alloys	>12% Si	High temperature	22-25	24-30
		>1% Pb	Free cutting		
			Brass		
Non metallic		Duroplastics, fiber plastics	35-45		
		Hard rubber			
S	High temp. alloys, Super alloys	Fe based	Annealed	15-20	18-24
		Ni or Co based	Annealed		
			Cast		
	Titanium alloys		Alpha+beta alloys cured	12-18	15-20
H	Hardened steel		Hardened 45-50 HRC	15-20	18-24
			Hardened 51-55 HRC		
			Hardened 56-62 HRC		
	Chilled cast iron		cast	10-14	12-16
Cast iron		Hardened	8-12	10-14	

Threading Passes

Recommended Feed Rate: 0.01 - 0.03 mm/rev

Pitch:	mm	0.5	0.7	0.8	1.0	1.25	1.5	2-5
	TPI	48	36	32	24	20	16	
Number of Passes		6-12	7-14	7-16	8-18	8-20	10-22	20-38

Thread Whirling Tools



For Perfect Long Threads on Swiss Type Machines

Thread Whirling is a fast and accurate way to thread long, small diameter parts in exotic materials such as titanium, stainless steel and inconel.

Whirling inserts and holders can produce a wide range of medical parts such as dental implants and bone screws, automotive parts and semiconductor small parts.

Cutting is the result of the whirling ring rotating eccentrically at high speed about the slowly rotating workpiece. The advancement of the workpiece rotationally and the advancement of the tool head longitudinally correspond to the thread pitch required.

Turning direction of the whirling unit

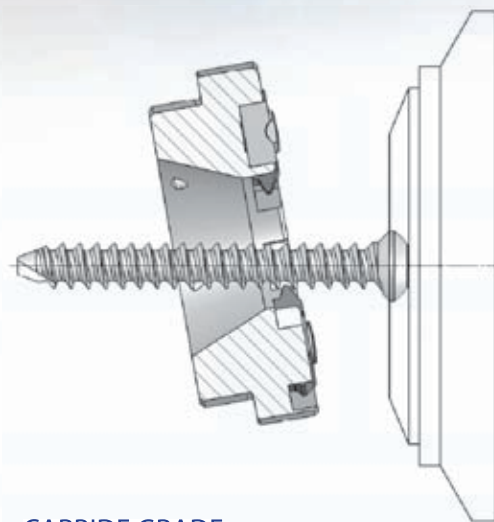

Turning direction of the bar



CARBIDE GRADE

BMA - PVD TiAlN coated submicrograin for stainless steel, exotic materials.

Contents:

Page

Thread Whirling Advantages

194

Product Identification

194

Ordering according to Machine Type or Model

195

Specials

196

Thread Whirling Advantages

Thread Whirling offers several advantages over single point threading:

Enables production of small diameter long threads when used on Swiss type machines, the thread whirling spindle works close to the guide bushing for increased support and rigidity.

Increased Productivity:

Short machining time Thread whirling is performed in a single pass. This eliminates multiple passes required for a single point threading.

Thread whirling allows working at high feed rates and consequently short cycle times.

Very high surface quality and accurate geometry:

The use of up to 8 cutting edges, higher concentricity, special cutting edge geometry and ideal chip removal, enable top quality surfaces to be produced without burr.

Long tool life:

Whirling inserts have a stronger cutting edge than single point tools, because cutter side clearance is achieved by rotating the whirling spindle, not by relieving material under the cutting edge.

Faster Setup:

Thread whirling eliminates special support devices and expensive startup development costs.

Compensation of large helix angles:

Large helix angles can be compensated by adjusting the whirling unit.

- One toolholder can be used for various applications.
- All toolholders are standard stock items.
- Inserts are made for each application as a special item.
- The toolholders are designed according to different machine types and manufacturers.
- Special adaptors for machine heads are available as stock items.

Product Identification

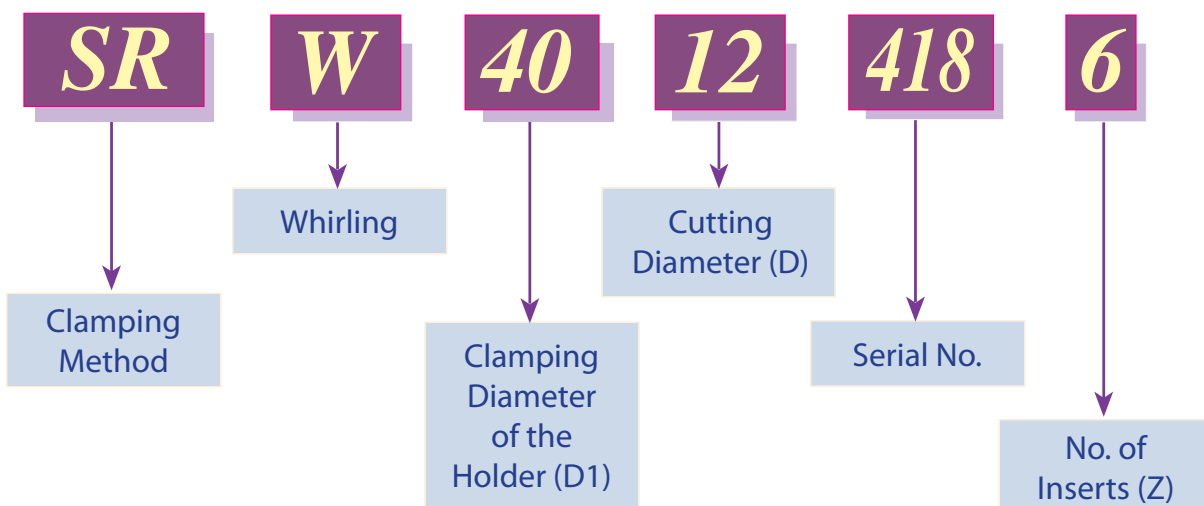

Toolholders & Adaptors

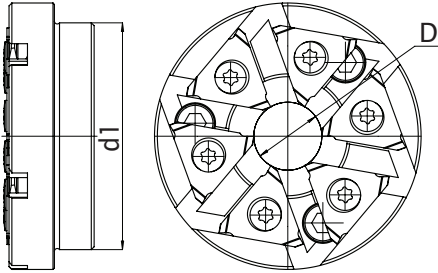

Machine		Whirling Holder Ordering Code	Adaptor Ordering Code	Z	D	d1	Insert Size	Insert Screw	Torx Key
Type	Model								
Star	SV12 / SV20	SRW4012 418 - 6	-	6	12	40	16	SW16	KW16
		SRW4012 424 - 8	WA4012 537	8			11	SW11	KW11
	SR20 / ECAS20	SRW4012 419 - 6	-	6			16	SW16	KW16
		SRW4012 425 - 8	WA4012 439	8			11	SW11	KW11
Citizen	M12 / M16	SRW4512 422 - 6	-	6	12	45	16	SW16	KW16
		SRW4512 426 - 8	WA4512 443	8			11	SW11	KW11
	M20 / M32	SRW4512 423 - 6	-	6			16	SW16	KW16
		SRW4512 427 - 8	WA4512 536	8			11	SW11	KW11
Tornos	DECO 13 / 20	SRW4012 420 - 6	-	6	12	40	16	SW16	KW16
Traub	TNL26 / TNK36	SRW4116 421 - 6	-	6	16	41	16	SW16	KW16
Hanwha	SL26HPD	SRW4012 416 - 3	-	3	12	40	16	SW16	KW16
Maier	ML20D	SRW4012 417 - 5	-	5	12	40	16	SW16	KW16

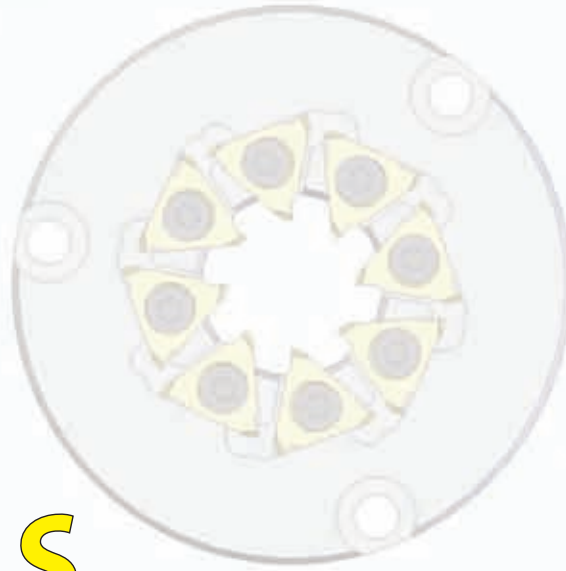

SPECIALS
ARE OUR SPECIALITY









 **Carmex**
Precision Tools Ltd.

1st Hacharoshet St., Maalot Industrial Zone 24952, ISRAEL
Tel: (972) 4-9077400, Fax: (972) 4-9077440.
E-mail: info@carmex.com Website: www.carmex.com
Postal address: P.O. Box 404, Maalot 24952, ISRAEL.